

PowerPact™ H-, J-, and L-Frame Circuit Breakers

Catalog
0611CT1001 R01/13
2013
Class 0611



CONTENTS

Description	Page
Catalog Numbering	7
General Information	10
Circuit Breakers	22
Automatic Switches	42
Motor Circuit Protection	46
Trip Units	58
Accessories for Micrologic™ Trip Units	77
Accessories and Auxiliaries	94
Circuit Breaker Mounting and Connections	117
Installation Recommendations	130
Wiring Diagrams	140
Dimensions	149
Trip Curves	172
Catalog Numbers	230
Glossary	236



by Schneider Electric

PowerPact™ H-, J-, and L-Frame Circuit Breakers

PowerPact™ H-, J-, and L-Frame Circuit Breakers

SECTION 1: CATALOG NUMBERING	7
PowerPact™ with Micrologic™ Circuit Breakers	7
Catalog Numbering	8
SECTION 2: GENERAL INFORMATION	10
Applications	10
Mission Critical Circuit Breakers	12
Flexible Configurations	14
General Characteristics	15
PowerPact H-, J-, and L-frame Circuit Breaker Trip Units	20
SECTION 3: CIRCUIT BREAKERS	22
Dual-Break Rotating Contacts	22
High Ampere Interrupting Ratings (AIR)	22
Internal Operating Mechanism	22
Handle Position Indication	23
Circuit Breaker Ratings	23
Special Applications	25
H- and J-Frame Catalog Numbers	26
L-Frame Circuit Breaker Catalog Numbers	36
SECTION 4: AUTOMATIC SWITCHES	42
Automatic Switch Functions	42
Specifications	43
Catalog Numbers	44
SECTION 5: MOTOR CIRCUIT PROTECTION	46
General Information	46
Motor Branch Circuit Protection Function	46
Trip Class of a Overload Relay Device	47
Asynchronous-Motor Starting Parameters	47
Motor-Feeder Solutions	47
Electronic Motor Circuit Protectors (AC Only)	49
Micrologic 1.3 M Electronic Trip Units for Instantaneous Protection Only (L-Frame Circuit Breakers Only)	52
Micrologic 2.2 M and 2.3 M Electronic Trip Units	53
Indications	54

PowerPact™ H-, J-, and L-Frame Circuit Breakers

SECTION 6: TRIP UNITS	58
Available Trip Units	58
Protection of Distribution Systems	61
SECTION 7: ACCESSORIES FOR MICROLOGIC™ TRIP UNITS	77
Display Options	77
Circuit Breaker Communication Network Options	80
SECTION 8: ACCESSORIES AND AUXILIARIES	94
Communication Network	94
Accessory Connections	97
Auxiliary and Alarm Indication Contacts	97
SDx and SDTAM Modules for Micrologic	99
Shunt Trip (MX) and Undervoltage Trip (MN)	101
Motor Operator	102
Add-On Ground-Fault Module (GFM) (H- and J-Frame Only)	104
Earth Leakage Module (ELM) (H- and J-Frame Only)	105
Rotary Operating Handles	106
Class 9422 Flange-Mounted Variable-Depth Operating Mechanism	109
Locking Systems	109
Manual Mechanical Interlocking Systems	110
Sealing Accessory	113
Front-Panel Escutcheons	113
Toggle Collars (For Drawout Mounting)	114
Toggle Boot	114
Handle Extension	114
Circuit Breaker Enclosures and Enclosure Accessories	115
SECTION 9: CIRCUIT BREAKER MOUNTING AND CONNECTIONS	117
Mounting Configurations	117
Unit-Mount Circuit Breakers	118
I-Line™ Circuit breakers	119
Connection	123

PowerPact™ H-, J-, and L-Frame Circuit Breakers

SECTION 10: INSTALLATION RECOMMENDATIONS	130
Operating Conditions	130
Installation in Equipment	133
Safety Clearances and Minimum Distances	133
Safety Clearance	134
Control Wiring	135
24 Vdc Power Supply Module	137
Wiring	138
Modbus	139
SECTION 11: WIRING DIAGRAMS	140
SECTION 12: DIMENSIONS	149
SECTION 13: TRIP CURVES	172
CATALOG NUMBERS	230
GLOSSARY	236

PowerPact™ H-, J-, and L-Frame Circuit Breakers

Section 1—Catalog Numbering

PowerPact™ with Micrologic™ Circuit Breakers

The PowerPact H-, J-, and L-frame circuit breakers are designed to protect electrical systems from damage caused by overloads and short circuits. H- and J-frame circuit breakers are available with either thermal-magnetic or Micrologic electronic trip units. L-frame circuit breakers are available with Micrologic electronic trip unit.



Direct Access to Energy Management

The new generation PowerPact with Micrologic circuit breakers set the standard with direct access to energy management. Integrated metering enhances their protective functions. For the first time, Schneider Electric™ users can monitor energy from 15 A to 3000 A, offering new performance in a remarkably compact device.

- Smart – A meter in every breaker
- Safe – Combines safety and performance in one compact device
- Simple – To select, install, and use

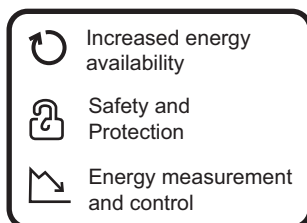

PowerPact™ H-, J-, and L-Frame Circuit Breakers Catalog Numbering

Catalog Numbering

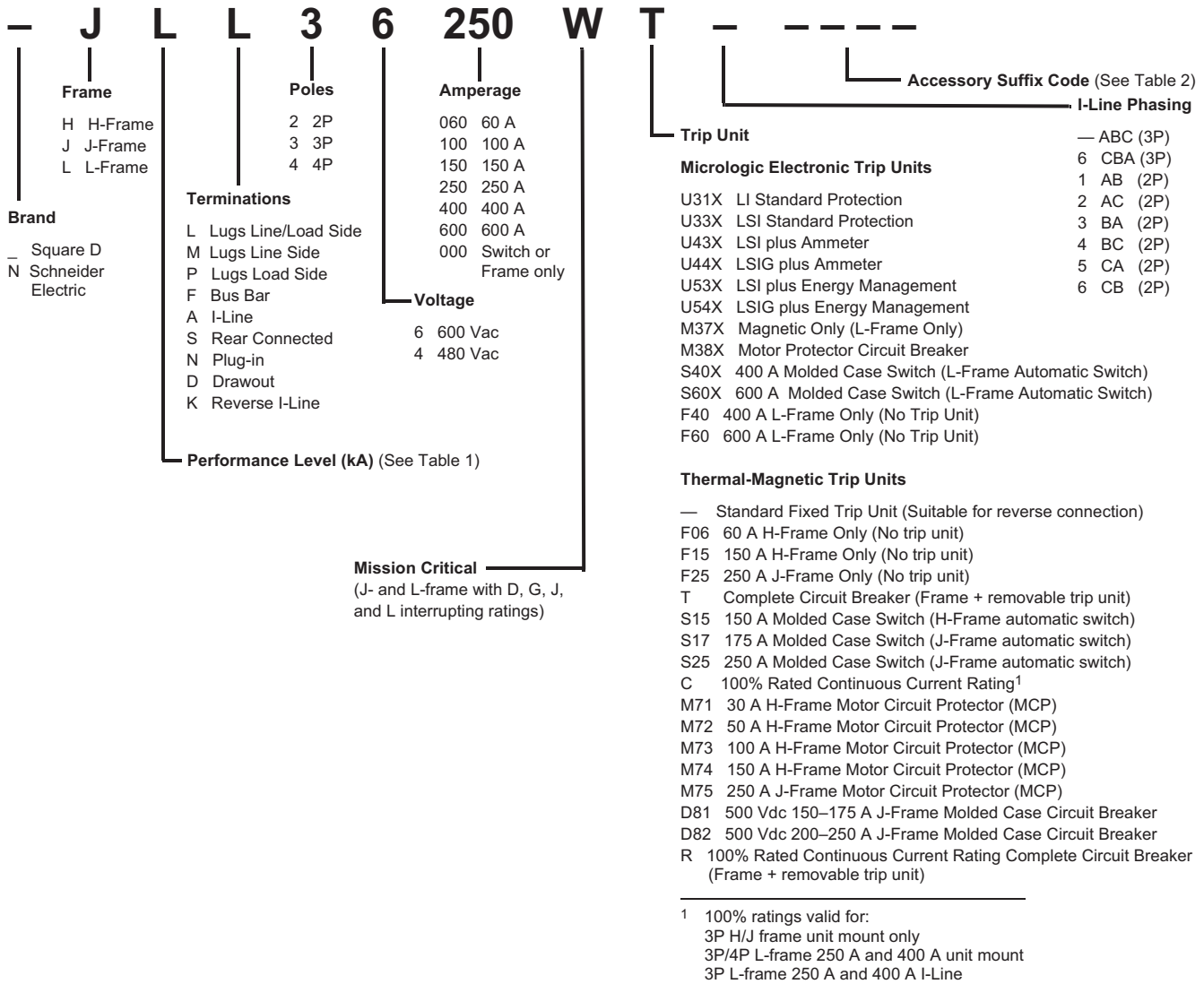

Table 1: Interrupting Rating

	UL® / CSA® / NOM®					IEC 647-2 Icu/Ics					
	240 Vac	480 Vac	600 Vac	250 Vdc ¹	500 Vdc ²	220/240 Vac	380/440/415 Vac	500/525 Vac	690 Vac	250 Vdc ¹	500 Vdc ³
D	25 kA	18 kA	14 kA	20 kA	—	25/25 kA	18/18 kA	14/14 kA	—	20 kA	20 kA
G	65 kA	35 kA	18 kA	20 kA	20 kA	65/65 kA	35/35 kA	18/18 kA	—	20 kA	20 kA
J	100 kA	65 kA	25 kA	20 kA	—	100/100 kA	65/65 kA	25/25 kA	—	20 kA	20 kA
L	125 kA	100 kA	50 kA	20 kA	—	125/125 kA	100/100 kA	50/50 kA	—	20 kA	20 kA
R	200 kA	200 kA	100 kA	—	—	150 kA	125 kA	75 kA	20 kA	—	—

¹ 250 Vdc ratings only available with PowerPact H or J circuit breakers with thermal-magnetic trip units (not including MCP).

² UL 500 Vdc ratings only available with PowerPact J circuit breakers with thermal-magnetic trip units (not including MCP).

³ IEC 500 Vdc rating only available on PowerPact J-frame circuit breakers.

PowerPact™ H-, J-, and L-Frame Circuit Breakers Catalog Numbering

Table 2: Factory Installed Accessory Suffix Codes (Building Sequence as Listed) and Field-Installable Kit Number

(1) Communication Networks ¹			
Suffix	Description	Kit No.	
EA	NSX Cord 1.3 m, V ≤ 480 V	S434201	
EB	NSX Cord 3 m, V ≤ 480 V	S434202	
ED	NSX Cord 1.3 m, V > 480 V	S434204	
EE	NSX Cord 3 m, V > 480 V	S434303	
EG ⁴	BSCM + NSX Cord 1.3 m, V ≤ 480 V	S434201BS	
EH ⁴	BSCM + NSX Cord 3 m, V ≤ 480 V	S434202BS	
EK ⁴	BSCM + NSX Cord 1.3 m, V > 480 V	S434204BS	
EL ⁴	BSCM + NSX Cord 3 m, V > 480 V	S434303BS	
EN	24 Vdc Power Supply Terminal Block	S434210	

(2) Indication Contacts			
Suffix	Description	Kit No.	
V	SDX	S429532	
	SDTAM (motor only trip units)	S429424	

(3) Auxiliary Switch			
Suffix	Contacts	Kit No.	Kit Qty.
AA	1A/1B Standard	S29450	1
AB	2A/2B Standard	S29450	2
AC	3A/3B Standard (L-frame only)	S29450	3
AE	1A/1B Low-Level	S29452	1
AF	2A/2B Low-Level	S29452	2
AG	3A/3B Low Level (L-frame only)	S29452	3

(4) Alarm/Overcurrent Trip Switch			
Suffix	Switch	Kit No.	Kit Qty.
PowerPact L-Frame and PowerPact H/J-Frame with Micrologic 5/6 trip units			
BC	Alarm Switch	S29450	1
BH	Alarm Switch Low-Level	S29452	1
BD	Overcurrent Trip Switch, Standard SDE Actuator	S29450 S29451	1 1
BJ	Overcurrent Trip Switch, Low-Level SDE Actuator	S29452 S29451	1 1
BE	Alarm Switch and Overcurrent Trip Switch, Standard	S29450	2
BK	Alarm Switch and Overcurrent Trip Switch, Low-Level	S29452	2
PowerPact H/J-Frame with Thermal-Magnetic or Micrologic 1/2/3 trip units			
BC	Alarm Switch	S29450	1
BH	Alarm Switch Low-Level	S29452	1
BD	Overcurrent Trip Switch, Standard SDE Actuator	S29450 S29451	1 1
BJ	Overcurrent Trip Switch, Low-Level SDE Actuator	S29452 S29451	1 1
BE	Alarm Switch and Overcurrent Trip Switch, Standard SDE Actuator	S29450 S29451	2 1
BK	Alarm Switch and Overcurrent Trip Switch, Low-Level SDE Actuator	S29452 S29451	2 1

(5) Shunt Trip				
Suffix	Kit No.	(6) Undervoltage Release UVR		Voltage
Suffix	Kit No.	Suffix	Kit No.	
SK	S29384	UK	S29404	24 Vac
SL	S29385	UL	S29405	48 Vac
SA	S29386	UA	S29406	120 Vac
SD	S29387	UD	S29407	208/277 Vac
SH	S29388	UH	S29408	380/480 Vac
SJ	S29389	UJ	S29409	525/600 Vac
SN	S29382	UN	S29402	12 Vdc
SO	S29390	UO	S29410	24 Vdc
SU	S29391	UU	S29411	30 Vdc
SP	S29392	UP	S29412	48 Vdc
SV	S29383	UV	S29403	60 Vdc
SR	S29393	UR	S29413	125 Vdc
SS	S29394	US	S29414	250 Vdc

(6) Communicating Motor Operator ⁵				
Suffix	Voltage	H-Frame	J-Frame	L-Frame
NC	220/240 Vac	S429441	S431549	S432652

(7) Motor Operator				
Suffix	Voltage	H-Frame	J-Frame	L-Frame
ML	48/60 Vac	S29440	S31548	S432639
MA	120 Vac	S29433	S31540	S432640
MD	277 Vac	S29434	S31541	S432641
MF	380/415 Vac	—	—	S432642
MH	440/480 Vac	S29435	S31542	S432647
MO	24/30 Vdc	S29436	S31543	S432643
MV	48/60 Vdc	S29437	S31544	S432644
MR	110/130 Vdc	S29438	S31545	S432645
MS	250 Vdc	S29439	S31546	S432646

(8) Rotary Handle			
Suffix	Handle Type (color)	H/J-Frame	L-Frame
RD10	Direct Mount (black)	S29337	S32597
RD20	Direct Mount (red)	S29339	S32599
RE10	Extended Door Mount (black)	S29338	S32598
RT10	Telescoping (black)	S29343	S32603
RE20	Extended Door Mount (red)	S29340	S32600

(9) Wire Harnesses ²		
Suffix	Harness ²	Kit No.
YH3	ZSI Wire Harness, H/J Frame	S434300
YH3	ZSI Wire Harness, L-Frame	S434301
YH2	ENCT Wire Harness	S434302
YH1	OF Wire Harness	S434500
YH1	SD/SDE Wire Harness	S434501
YH1	SDx/SDTAM Wire Harness	S434502
YH1	MN Wire Harness	S434503
YH1	MX Wire Harness	S434504
YH1	Motor Operator Wire Harness	S434506
YH1	Communicating Motor Operator Wire Harness	S434507
YH1 ³	NSX Wire Harness	S434508
YH4	ENCT and ZSI Wire Harnesses	—
YH1 ³	24 Vdc Power Supply Wire Harness	S434505

(10) Handle Padlocks			
Suffix	Padlock Type	H/J-Frame	L-Frame
YP	Handle Padlock, ON or OFF	S29371	S32631
YQ	Handle Padlock, OFF Only	S37422	NJPAF

¹ Except for 24 Vdc Power Supply Terminal Block, installation requires IFM (STRV00210) for Modbus communication and/or FDM (STRV00121) for external display.
² YH1 = all installed accessories but ZSI and ENCT
YH2 = ENCT and all installed accessories
YH3 = ZSI and all installed accessories
YH4 = ZSI, ENCT and all installed accessories
³ I-Line wire harness included for communication network accessories. Optional wire harness for unit mount requires YH1 suffix.
⁴ If using with a motor operator, requires Communicating Motor Operator (suffix NC).
⁵ Requires Micrologic trip unit U43, U44, U53, or U54 and communication accessories EG, EH, EK, or EL.

Section 2—General Information

The PowerPact™ H-, J-, and L-frame circuit breakers are designed to protect electrical systems from damage caused by overloads and short circuits. H- and J-frame circuit breakers are available with either thermal-magnetic or Micrologic™ electronic trip units. L-frame circuit breakers are available with Micrologic electronic trip unit.

H- and J-frame circuit breakers with thermal-magnetic trip units contain individual thermal (overload) and instantaneous (short circuit) sensing elements in each pole. The amperage ratings of the thermal trip elements are calibrated at 104°F (40°C) free air ambient temperature. Per the National Electric Code® (NEC®) and the Canadian Electrical Code, standard circuit breakers may only be applied continuously at up to 80% of their rating. Circuit breakers rated for 100% operation are available but require specially-designed enclosures, copper lugs, and 194°F (90°C) rated wire.

Devices with the Micrologic electronic trip unit provide adjustable protection settings for greater system flexibility. In addition to electronic protection, Micrologic trip units allow users to monitor both energy and power. Through direct access to in-depth information and networking using open protocols, PowerPact circuit breakers with Micrologic trip units let operators optimize the management of their electrical installations. Far more than a circuit breaker, these circuit breakers are a measurement and communication tool ready to meet energy-efficiency needs through optimized power requirements, increased energy availability, and improved installation management.

Applications

PowerPact H-, J-, and L-frame circuit breakers offer high performance and a wide range of interchangeable trip units to protect most applications.

Electronic trip units provide highly accurate protection with wide setting ranges and can integrate measurement, metering and communication functions. They can be combined with the front display module (FDM121) to provide functions similar to a power meter.

Table 3: Applications

	Power Meter	PowerPact H-, J-, and L-frame circuit breakers equipped with Micrologic 5 / 6 trip units offer type A (ammeter) or E (energy) metering functions as well as communication capability. Using Micrologic trip unit sensors and intelligence, PowerPact H-, J-, and L-frame circuit breakers provide access to measurements of all the main electrical parameters on the built-in screen, on a dedicated front display module (FDM121) or through the communication network.
	Operating assistance	Integration of measurement functions provides operators with operating assistance functions including alarms tripped by user-selected measurement values, time-stamped event tables and histories, and maintenance indicators.
	Front display module	The main measurements can be read on the built-in screen of Micrologic 5 / 6 trip units. They can also be displayed on the equipment FDM121 along with pop-up windows signalling the main alarms.
	Communication Network	PowerPact H-, J-, and L-frame circuit breakers equipped with Micrologic 5 / 6 trip units provide communication capabilities. Simple RJ45 cables connect to a Modbus communication interface module.

PowerPact™ H-, J-, and L-Frame Circuit Breakers General Information

Table 3: Applications

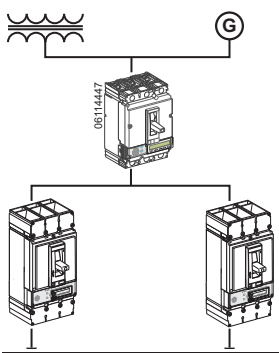
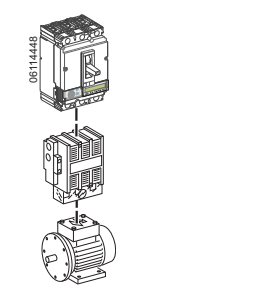
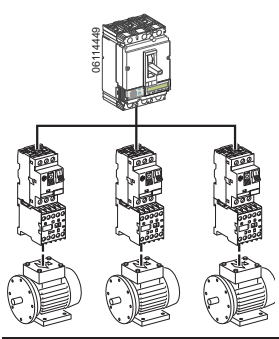
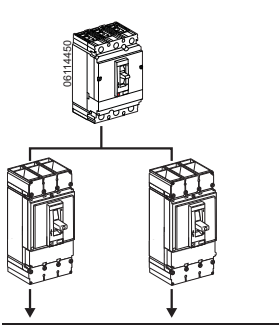
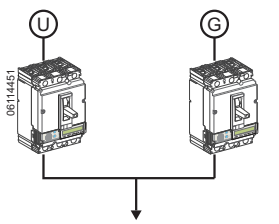
	<p>Protection of distribution systems</p> <p>Mission critical applications</p>	<p>The PowerPact H-, J-, and L-frame circuit breakers provide protection against short circuits and overloads for:</p> <ul style="list-style-type: none"> distribution systems supplied by transformers distribution systems supplied by engine generator sets <p>They are easily installed at all levels in distribution systems, from the main LV switchboard to the subdistribution boards and enclosures. All PowerPact circuit breakers can protect against insulation faults by adding an external Vigirex relay.</p> <p>The PowerPact H-, J-, and L-frame mission critical circuit breakers provide high levels of selective coordination with QO and ED/EG/EJ circuit breakers.</p>
	<p>Protection of motors</p>	<p>The PowerPact H-, J-, and L-frame circuit breakers include a number of versions to protect motor applications:</p> <ul style="list-style-type: none"> basic short-circuit protection with electronic instantaneous only MCP or the electronic Micrologic 1.3 M trip units, combined with a special overload relay to provide thermal protection protection against overloads, short circuit and phase unbalance or loss with Micrologic 2 M trip units <p>The exceptional limiting capacity of the PowerPact circuit breakers automatically provides coordination with the motor starter.</p>
	<p>Protection of special applications</p>	<p>The PowerPact H-, J-, and L-frame circuit breakers offer a number of version for special protection applications:</p> <ul style="list-style-type: none"> industrial control panels with: <ul style="list-style-type: none"> — compliance with international standards IEC 60947-2 and UL 508/CSA 22.2 N°14 — compliance with UL 489 — installation in universal and functional enclosures 400 Hz systems
	<p>Control using automatic switches</p>	<p>An automatic switch version of PowerPact H-, J-, and L-frame circuit breakers is available for circuit control. All add-on functions for the circuit breakers may be combined with the basic automatic switch function, including motor operators.</p> <p>For information on other automatic switches, contact Schneider Electric.</p>
	<p>Manual transfer systems</p>	<p>To ensure a continuous supply of power, some electrical installations are connected to two power systems:</p> <ul style="list-style-type: none"> the normal source, usually the utility (U) a replacement source to supply the installation when the normal source is not available, generally from a generator (G) <p>A mechanical and/or electrical interlocking system between two circuit breakers or automatic switches avoids all risk of parallel connection of the sources during switching.</p> <p>A system can be manual transfer mechanical device interlocking.</p>

Mission Critical Circuit Breakers

The PowerPact™ J- and L-Frame Mission Critical circuit breakers deliver high levels of selective coordination in a flexible design that can be easily configured for a variety of applications. Tested to be selectively coordinated with the QO™ family of miniature circuit breakers and the ED, EG, and EJ circuit breakers, this solution provides peace of mind when power availability is critical.

An electronic trip unit provides adjustable long-time settings in three sensor sizes, allowing coverage from 70 through 600 A on 120-240, 208Y/120, 240, and 480Y/277 V systems.

Ratings	Available Configurations
UL 489 Listed CSA Certified Voltage: 480Y/277 V	<ul style="list-style-type: none">• I-Line mounting• Main circuit breaker in NQ and NF panelboards• Unit mount for OEM users• Plug-in base for OEM users• Drawout base for OEM users

In addition to unique design attributes, the PowerPact Mission Critical circuit breakers have also undergone rigorous testing procedures to certify the coordination with downstream circuit breakers—combining innovative engineering with validated test results.

Apply Schneider Electric Mission Critical circuit breakers in emergency power distribution systems, data centers, hospitals, or anywhere continuity of service is desired.

Theory of Operation

There are several dynamic forces between the PowerPact Mission Critical circuit breakers and downstream circuit breakers when a fault occurs downstream of the branch circuit breaker. Many of these events cannot be shown on the trip curve.

The PowerPact Mission Critical circuit breakers analyze the fault current to make decisions which maximize selectivity with downstream circuit breakers. The trip units deploy a special selectivity delay to allow downstream circuit breakers to clear. However, on very high faults or if the downstream circuit breaker does not trip, the circuit breaker trips the mechanism instantaneously.

The combination of the PowerPact Mission Critical circuit breaker and downstream circuit breakers shown in the selectivity charts in the instruction bulletin are selective due to the fact that the series impedance and the let-through from the downstream circuit breaker does not produce enough energy to trip the PowerPact Mission Circuit circuit breaker.

This system maximizes the interaction of the circuit breakers in series to allow selectivity.

The PowerPact J- and L-Frame Mission Critical Circuit Breaker is specifically designed to provide selective coordination with QO and E-frame circuit breakers during a short-circuit condition.

PowerPact™ H-, J-, and L-Frame Circuit Breakers General Information

J-frame mission critical circuit breakers are selective with QO or E-frame circuit breakers per Table 4 when the amperage of the main circuit breaker is at least two times the amperage of the branch circuit breaker.

Table 4: J-Frame Selectivity with QO and E-Frame Circuit Breakers¹

Circuit Breaker			Voltage	Current	One-Line Diagram	
Main	Branch					
J-W, 250 A	QO(B) QO(B)-H QO(B)-VH QH	1P, 2P	10–30 A	240/120 V 120 V	18 kA	
			35–60 A		15 kA	
			70–125 A		12 kA	
	QH	3P	10–30 A	240 V 208 V	15 kA	
			35–60 A		13 kA	
			70–125 A		10 kA	
J-W, 250 A	E-Frame	1P, 2P, 3P	15–125 A	240 V	18 kA	
			15–60 A		10 kA	
			70–125 A	480Y/277 V	7 kA	

¹ Including AFI, CAFI, EPD and GFI circuit breakers.

L-frame mission critical circuit breakers are selective with QO-style and E-frame circuit breakers per Table 5 when the amperage of the main circuit breaker is at least two times greater than the amperage of the branch circuit breaker.

Table 5: L-Frame Selectivity with QO and E-Frame Circuit Breakers¹

Circuit Breaker			Voltage	Current	One-Line Diagram
Main	Branch				
L-W, 250 A	QO(B) QO(B)-H QO(B)-VH QH	10–60 A	240 V	18 kA	
		70–125 A		10 kA	
L-W, 400 A L-W, 600 A	QO(B) QO(B)-H QO(B)-VH QH	15–150 A	240 V	30 kA	
L-W, 250 A L-W, 400 A L-W, 600 A	E-Frame	15–125 A	240 V	30 kA	
			480Y/277 V	30 kA	

¹ Including AFI, CAFI, EPD and GFI circuit breakers.

PowerPact™ H-, J-, and L-Frame Circuit Breakers

General Information

Flexible Configurations

The PowerPact H-, J- and L-frame circuit breakers may be configured with lugs, bus bar connections, rear connections, I-Line™, drawout cradle, or plug-in base.

Field Installable Accessories and Trip Units

Figure 1: Field Installable Accessories and Trip Units

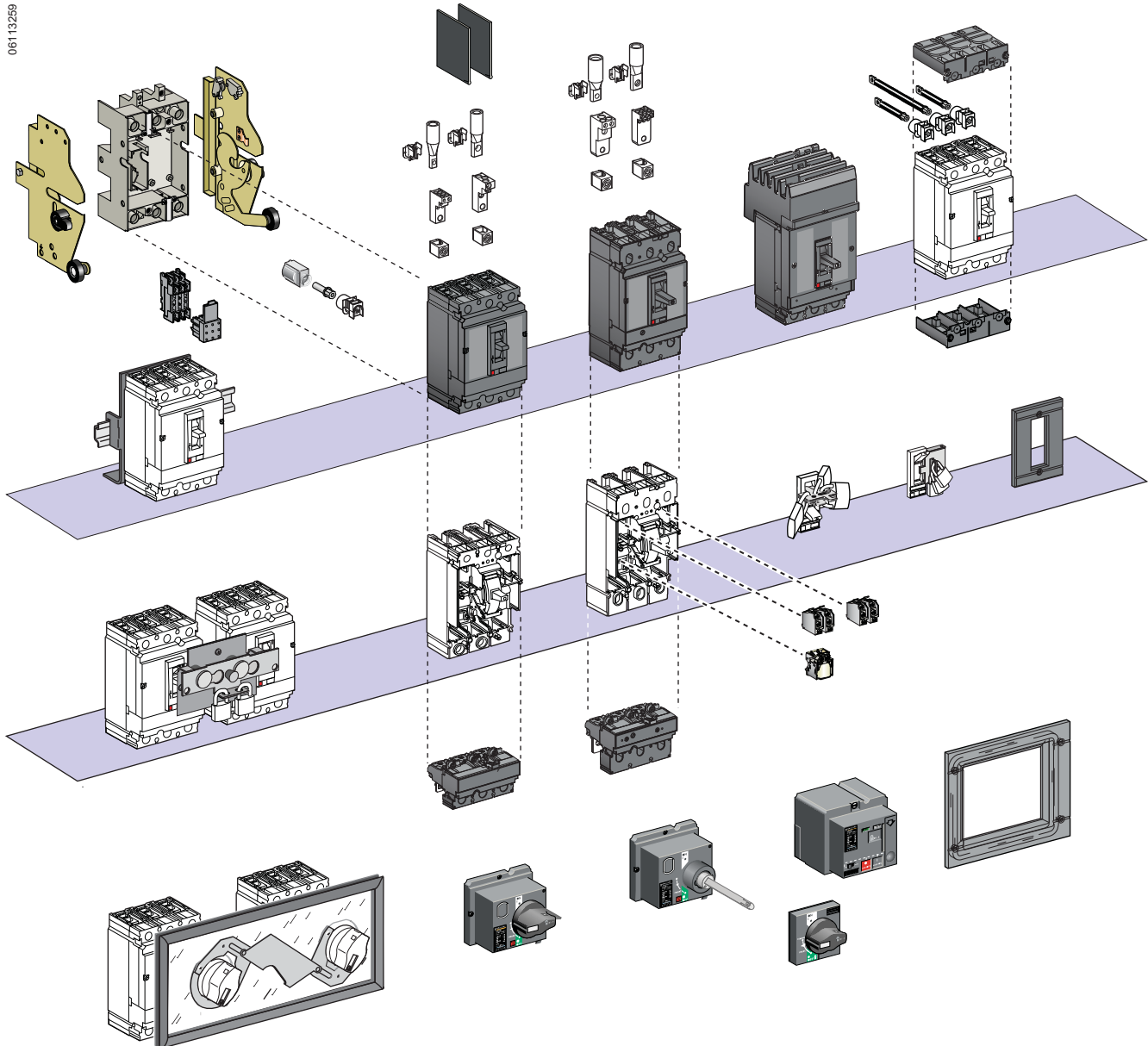

06113259

General Characteristics

Faceplate Label

<p>0613883 PowerPact™ HD 150</p> <p>Circuit Breaker Interruptor Automático Disjoncteur HDA36100</p> <p>Interrupting Rating Valor de Interrupción Valeur d'interruption (V) (kA) 50/50 Hz</p> <table border="1"> <tr><td>240</td><td>~</td><td>25</td></tr> <tr><td>480</td><td>~</td><td>18</td></tr> <tr><td>600</td><td>~</td><td>14</td></tr> <tr><td>240 1Ø - 3Ø</td><td></td><td>42</td></tr> <tr><td>480 1Ø - 3Ø</td><td></td><td>18</td></tr> <tr><td>250 ---</td><td></td><td>20</td></tr> </table> <p>AIR/Anom 50/60 Hz</p> <table border="1"> <tr><td>Ue (V)</td><td>Icu (kA)</td><td>Ics (kA)</td></tr> <tr><td>220/240 ~</td><td>25</td><td>25</td></tr> <tr><td>380/440 ~</td><td>18</td><td>18</td></tr> <tr><td>400/525 ~</td><td>14</td><td>14</td></tr> </table> <p>Ui 750V Uimp 8kV</p> <p>UL LISTED C.B. ISSUE No. 186 E10027 153555 CSA NOM 117 ANCE</p>	240	~	25	480	~	18	600	~	14	240 1Ø - 3Ø		42	480 1Ø - 3Ø		18	250 ---		20	Ue (V)	Icu (kA)	Ics (kA)	220/240 ~	25	25	380/440 ~	18	18	400/525 ~	14	14	<p>Characteristics indicated on the faceplate label:</p> <p>A. Circuit breaker type B. Circuit breaker disconnecter symbol C. Performance levels D. Standards E. Ue: Operating voltage per IEC F. Icu: Ultimate breaking capacity per IEC G. Ics: Service breaking capacity per IEC H. Uimp: Rated impulse withstand voltage per IEC I. Ui: Insulation voltage per IEC J. Certification marks</p> <p>NOTE: When the circuit breaker is equipped with an extended rotary handle, the door must be opened to view the faceplate.</p>
240	~	25																													
480	~	18																													
600	~	14																													
240 1Ø - 3Ø		42																													
480 1Ø - 3Ø		18																													
250 ---		20																													
Ue (V)	Icu (kA)	Ics (kA)																													
220/240 ~	25	25																													
380/440 ~	18	18																													
400/525 ~	14	14																													

Codes and Standards

H-, J-, and L-frame circuit breakers, automatic switches and electronic motor circuit protectors are manufactured and tested in accordance with the following standards.

NOTE: Apply circuit breakers according to guidelines detailed in the National Electric Code (NEC) and other local wiring codes.

Table 6: Codes and Standards (Domestic)

PowerPact H-, J-, and L-Frame Circuit Breakers	H-, J-, and L-Frame Switches	PowerPact H-, J-, and L-Frame Motor Circuit Protectors
UL 489 ¹	UL 489 ³	UL 508
IEC 60947-2	IEC 60947-3	IEC 60947-2
CSA C22.2 No. 5 ²	CSA C22.2 No. 5 ⁴	CSA C22.2 No. 14
Federal Specification W-C-375B/GEN	Federal Specification W-C-375B/GEN	NEMA AB1
NEMA AB1	NEMA AB1	CCC
NMX J-266	NMX J-266	CE Marking
CCC	CE Marking	
CE Marking		

¹ PowerPact H- and J-frame circuit breakers are in UL File E10027. PowerPact L-frame circuit breakers are in UL File E63335.
² PowerPact H- and J-frame circuit breakers are in CSA File LR40970. PowerPact L-frame circuit breakers are in CSA File 69561.
³ PowerPact H- and J-frame switches are in UL File E87159.
⁴ PowerPact H- and J-frame switches are in CSA File LR32390.

PowerPact™ H-, J-, and L-Frame Circuit Breakers

General Information

Vibration

PowerPact H-, J-, and L-frame devices resist mechanical vibration.

Tests are carried out in compliance with standard UL 489 SA and SB for the levels required by merchant-marine inspection organizations (Veritas, Lloyd's, etc.):

PowerPact H-, J-, and L-frame circuit breaker meet IEC 60068-2-6 for vibration:

- 2.0 to 25.0 Hz and amplitude +/- 1.6 mm
- 25.0 to 100 Hz acceleration +/- 4.0 g

Excessive vibration may cause tripping, breaks in connections or damage to mechanical parts.

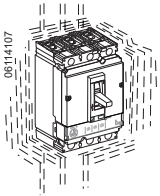

Electromagnetic disturbances

PowerPact H-, J-, and L-frame devices are protected against:

- overvoltages caused by circuit switching
- overvoltages caused by an atmospheric disturbances or by a distribution-system outage (such as from failure due to lightning)
- devices emitting radio waves (radios, walkie-talkies, radar, etc.)
- electrostatic discharges produced directly by users

PowerPact H-, J-, and L-frame devices have successfully passed the electromagnetic-compatibility tests (EMC) defined by the following international standards:

- IEC/EN 60947-2: Low-voltage switchgear and controlgear, part 2: Circuit breakers:
 - Annex F: Immunity tests for circuit breakers with electronic protection
 - Annex B: Immunity tests for residual current protection
- IEC/EN 61000-4-2: Electrostatic-discharge immunity tests
- IEC/EN 61000-4-3: Radiated, radio-frequency, electromagnetic-field immunity tests
- IEC/EN 61000-4-4: Electrical fast transient/burst immunity tests
- IEC/EN 61000-4-5: Surge immunity tests
- IEC/EN 61000-4-6: Immunity tests for conducted disturbances induced by radio frequency fields
- CISPR 11: Limits and methods of measurement of electromagnetic disturbance characteristics of industrial, scientific and medical (ISM) radio-frequency equipment.

These tests ensure that:

- no nuisance tripping occurs
- tripping times are respected

Tropicalization

The materials used in PowerPact circuit breakers will not support the growth of fungus and mold.

PowerPact circuit breakers have passed the test defined below for extreme atmospheric conditions.

Dry cold and dry heat:

- IEC 68-2-1–dry cold at -55 °C
- IEC 68-2-2–dry heat at +85° C

Damp heat (tropicalization)

- IEC 68-2-30–damp heat (temperature + 55° C and relative humidity of 95%)
- IEC 68-2-52 level 2–salt mist

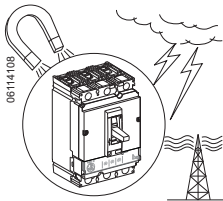

PowerPact™ H-, J-, and L-Frame Circuit Breakers

General Information

Special Ratings

The H-frame and J-frame circuit breakers also comply with the following special ratings:

- HACR rating
- SWD switch duty rating (applies only to 15 and 20 A / 277 Vac or less, 2P and 3P)
- HID high intensity discharge lighting rating (15–50 A)

The L-frame circuit breakers complies with the following special rating:

- HACR rating

Marine Ratings

UL Marine Listed/CSA Certified Circuit Breakers (UL 489 Supplement SA)

The PowerPact H- and J-frame circuit breakers with thermal-magnetic trip units meet the UL 489 Supplement SA requirements for use on vessels of any length under or over 65 ft. (19.8 m). The PowerPact H-, J-, and L-frame circuit breakers with Micrologic electronic trip units meet the UL 489 Supplement SA for use on vessels over 65 ft. (19.8 m) in length. Marine circuit breakers must not use aluminum or aluminum alloys for terminal connections and must be calibrated at an ambient temperature of 104° F (40° C). Standard circuit breakers should not be specified or used in the place of marine rated circuit breakers.

Circuit breakers can be ordered with the Marine SA listing by adding the suffixes “LC” (copper lugs) and “YA” (marine) to the catalog number.

UL Naval Listed/CSA Certified Circuit Breakers (UL 489 Supplement SB)

The PowerPact H-, J-, and L-frame circuit breakers with Micrologic trip units meet the UL 489 Supplement SB requirements for use on naval vessels. These circuit breakers are subject to various vibration tests as described in UL 489 Supplement SB. Naval circuit breakers must not use aluminum or aluminum alloys for terminal connections and must be calibrated at an ambient temperature of 122° F (50° C). Standard circuit breakers should not be specified or used in the place of naval rated circuit breakers.

Circuit breakers can be ordered with the Naval SB listing by adding the suffixes “LC” (copper lugs) and “YA1” (naval) to the catalog number.

American Bureau of Shipping (ABS)

The PowerPact H-, J-, and L-Frame circuit breakers are certified to ABS-NVR (American Bureau of Shipping - Naval Vessel Rules), for use on Naval vessels.

PowerPact™ H-, J-, and L-Frame Circuit Breakers

General Information

UL 489 SC Listed 500 Vdc Circuit Breakers

The UL Listed/CSA Certified thermal-magnetic J-Frame molded case circuit breakers are specifically designed for use on ungrounded dc systems having a maximum short-circuit voltage of 500 Vdc or a maximum floating (unloaded) voltage of 600 Vdc. The circuit breakers are suitable for use only with UPS (uninterruptable power supplies) and ungrounded systems. This two-level voltage rating allows these circuit breakers to be applied to battery sources having a short-circuit availability of 20,000 amperes at 500 Vdc.

These circuit breakers are UL Listed/CSA Certified for the interrupting ratings shown only if applied with three poles connected in series (series connection is external to circuit breaker). See diagram below.

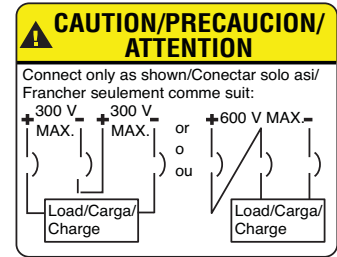

Source = 600 Vdc max. (floating)
500 Vdc max. (loaded)

NOTE: Due to external series connection, I-Line circuit breakers are not available for this application.

Table 7: DC Molded Case Circuit Breakers

Ampere Rating	Circuit Breaker Cat. No.	Adjustable Magnetic Trip Range—DC Amperes		Performance Level @ 500 Vdc
		Low	High	
100 A	JGL37100D81	400	600	20 k AIR
125 A	JGL37125D81	400	600	
150 A	JGL37150D81	400	600	
175 A	JGL37175D81	400	600	
200 A	JGL37200D82	500	850	
225 A	JGL37225D82	500	850	20 k AIR
250 A	JGL37250D82	500	850	

PowerPact™ H-, J-, and L-Frame Circuit Breakers General Information

Table 8: Circuit Breakers

Circuit Breaker		150 A H-Frame					250 A J-Frame					400 A L-Frame					600 A L-Frame														
Circuit Breaker Type		HD	HG	HJ	HL	HR	JD	JG	JJ	JL	JR	LD	LG	LJ	LL	LR	LD	LG	LJ	LL	LR										
Number of poles ¹		2, 3					3					2, 3					3					3, 4					3, 4				
Amperage Range (A)		15-150					70-250					70-400					200-600														
UL 489 Circuit Breaker Ratings																															
UL/CSA/NOM (kA rms)	240 Vac	25	65	100	125	200	25	65	100	125	200	25	65	100	125	200	25	65	100	125	200	25	65	100	125	200					
	480 Vac	18	35	65	100	200	18	35	65	100	200	18	35	65	100	200	18	35	65	100	200	18	35	65	100	200					
	600 Vac	14	18	25	50	100	14	18	25	50	100	14	18	25	50	100	14	18	25	50	100	14	18	25	50	100					
	250 Vdc ²	20	20	20	20	---	20	20	20	20	---	20	20	20	20	---	20	20	20	20	---	20	20	20	20	---					
	500 Vdc ^{2, 3}	---	---	---	---	---	20	---	---	---	---	---	---	---	---	---	---	---	---	---	---	---	---	---	---	---					
IEC 947-2 Circuit Breaker Ratings																															
Ultimate breaking capacity (Icu) (kA rms)	220/240 Vac	25	65	100	125	150	25	65	100	125	150	25	65	100	125	150	25	65	100	125	150	25	65	100	125	150					
	380/415 Vac	18	35	65	100	125	18	35	65	100	125	18	35	65	100	125	18	35	65	100	125	18	35	65	100	125					
	440/480 Vac	18	35	65	100	125	18	35	65	100	125	18	35	65	100	125	18	35	65	100	125	18	35	65	100	125					
	500/525 Vac	14	18	25	50	75	14	18	25	50	75	14	18	25	50	75	14	18	25	50	75	14	18	25	50	75 ⁴					
	690 Vac	---	---	---	---	20	---	---	---	---	20	---	---	---	---	20	---	---	---	---	20	---	---	---	---	20					
	250 Vdc ²	---	---	---	---	---	20	20	20	20	---	20	20	20	20	---	20	20	20	20	---	20	20	20	20	---					
500 Vdc ^{2, 3}	---	---	---	---	---	20	20	20	20	---	---	---	---	---	---	---	---	---	---	---	---	---	---	---	---						
Service breaking capacity (Ics) % Icu	100%					100%					100%					100%															
Insulation Voltage	V _i	750 Vac					750 Vac					750 Vac					750 Vac														
Impulse Withstand Voltage	V _{imp}	8 kVac					8 kVac					8 kVac					8 kVac														
Operational Voltage	V _e	690 Vac					690 Vac					690 Vac					690 Vac														
Sensor Rating	I _n	150 A					250 A					400 A					600 A														
Utilization Category	---	A					A					A					A														
Operations (Open-Close Cycles)																															
Without Current		4000					5000					5000					5000														
With Current		4000					1000					1000					1000														
Protection and Measurements																															
Short-circuit protection	Magnetic only	■	■	■	■	■	■	■	■	■	■	■	■	■	■	■	■	■	■	■	■	■	■	■	■	■					
	Thermal-magnetic	■	■	■	■	■	■	■	■	■	■	---	---	---	---	---	---	---	---	---	---	---	---	---	---	---					
	Electronic	■	■	■	■	■	■	■	■	■	■	■	■	■	■	■	■	■	■	■	■	■	■	■	■	■					
	with neutral protection (Off-0.5-1-OSN) ⁵	■	■	■	■	■	■	■	■	■	■	■	■	■	■	■	■	■	■	■	■	■	■	■	■	■					
	with ground fault protection	■	■	■	■	■	■	■	■	■	■	■	■	■	■	■	■	■	■	■	■	■	■	■	■	■					
with zone selective interlocking (ZSI) ⁶	■	■	■	■	■	■	■	■	■	■	■	■	■	■	■	■	■	■	■	■	■	■	■	■	■						
Display / I, V, f, P, E, THD measurements / interrupted-current measurement		■	■	■	■	■	■	■	■	■	■	■	■	■	■	■	■	■	■	■	■	■	■	■	■	■					
Options	Front display module (FDM121)	■	■	■	■	■	■	■	■	■	■	■	■	■	■	■	■	■	■	■	■	■	■	■	■	■					
	Operating assistance	■	■	■	■	■	■	■	■	■	■	■	■	■	■	■	■	■	■	■	■	■	■	■	■	■					
	Counters	■	■	■	■	■	■	■	■	■	■	■	■	■	■	■	■	■	■	■	■	■	■	■	■	■					
	Histories and alarms	■	■	■	■	■	■	■	■	■	■	■	■	■	■	■	■	■	■	■	■	■	■	■	■	■					
	Metering Com	■	■	■	■	■	■	■	■	■	■	■	■	■	■	■	■	■	■	■	■	■	■	■	■	■					
Device status/control com	■	■	■	■	■	■	■	■	■	■	■	■	■	■	■	■	■	■	■	■	■	■	■	■	■						
Dimensions / Weight / Connections																															
Dimensions 3P (Unit Mount) in. (mm)	Height	6.4 (163)					7.5 (191)					13.38 (340)					13.38 (340)														
	Width	4.1 (104)					4.1 (104)					5.51 (140)					5.51 (140)														
	Depth	3.4 (86)					3.4 (86)					4.33 (110)					4.33 (110)														
Weight 3P - lb. (Kg)		4.8 (2.2)					5.3 (2.4)					13.2 (6.0)					13.7 (6.2)														
Connections / Terminations	Unit Mount	■					■					■					■														
	I-Line	■					■					■					■														
	Rear Connection	■					■					■					■														
	Plug-In	■					■					■					■														
	Drawout	■					■					■					■														
	Optional Lugs	■					■					■					■														

¹ H and J-frame breakers with Micrologic trip units available only with 3P. The HJ, HL and the J-Frame 2P breakers are 3P modules.
² DC not available with PowerPact H, J or L-frame circuit breakers with Micrologic trip units.
³ 500 Vdc specific catalog numbers, ungrounded UPS systems only.
⁴ I_{cs} for 600 A L-frame circuit breaker at 525 V is 19 kA.
⁵ OSN: Over Sized Neutral protection for neutrals carrying high currents (e.g. 3rd harmonics).
⁶ ZSI using restraint wires.

PowerPact H-, J-, and L-frame Circuit Breaker Trip Units

Table 9: Micrologic Trip Unit Features

Features	Micrologic Trip Unit (X = Standard Feature, O = Available Option)					
	Standard		Ammeter		Energy	
	3.2/3.3	3.2S/3.3S	5.2A/5.3A	6.2A/6.3A	5.2E/5.3E	6.2E/6.3E
LI	X					
LSI ¹		X	X		X	
LSIG/Ground Fault Trip ²				X		X
Ground-Fault Alarm Trip				X		X
Current Settings Directly in Amperes	X	X	X	X	X	X
True RMS Sensing	X	X	X	X	X	X
UL Listed	X	X	X	X	X	X
Thermal Imaging	X	X	X	X	X	X
LED for Long-Time Pickup	X	X	X	X	X	X
LED for Long-Time Alarm	X	X	X	X	X	X
LED Green "Ready" Indicator	X	X	X	X	X	X
Up to 12 Alarms Used Together			X	X	X	X
Digital Ammeter			X	X	X	X
Zone-Selective Interlocking ³			X	X	X	X
Communications	O	O	O	O	O	O
LCD Display			X	X	X	X
Front Display Module FDM121			O	O	O	O
Advanced User Interface			X	X	X	X
Neutral Protection			X	X	X	X
Contact Wear Indication ⁴			X	X	X	X
Incremental Fine Tuning of Settings			X	X	X	X
Load Profile ^{4, 5}			X	X	X	X
Power Measurement					X	X
Power Quality Measurements					X	X

¹ The LSI with 3.2S/3.3S trip units have fixed short time and long time delays.

² Requires neutral current transformer on three-phase four-wire loads.

³ ZSI for H/J-frame devices is only IN. ZSI for L-frame devices is IN and OUT.

⁴ Indication available using the communication system only.

⁵ % of hours in 4 current ranges: 0–49%, 50–79%, 80–89%, and >90% I_n.

Thermal-Magnetic or Electronic Trip Unit?

Thermal-magnetic trip units (available on H- and J-frame circuit breakers only) protect against overcurrents and short-circuits using tried and true techniques. For applications requiring installation optimization and energy efficiency, electronic trip units offering more advanced protection functions combined with measurements.

Trip units using digital electronics are faster as well as more accurate. Wide setting ranges make installation upgrades easier. Designed with processing capabilities, Micrologic trip units can provide measurement information and device operating assistance. With this information, users can avoid or deal more effectively with disturbances and can play a more active role in system operation. They can manage the installation, anticipate events and plan any necessary servicing.

Accurate Measurements for Complete Protection

PowerPact H-, J-, and L-frame circuit breakers devices offer excellent measurement accuracy from 15 amperes on up to the short-circuit currents. This is made possible by a new generation of current transformers combining “iron-core” sensors for self-powered electronics and “air core” sensors (Rogowski coils) for measurements. The protection functions are managed by an ASIC (Application Specific Integrated Circuit) component that is independent of the measurement functions. This independence ensures immunity to conducted and radiated disturbances and increases reliability.

Numerous Security Functions

Torque-limiting screws	The screws secure the trip unit to the circuit breaker. When the correct tightening torque is reached, the screw heads break off. Optimum tightening avoids any risk of temperature rise. A torque wrench is no longer required.
Easy and sure changing of trip units	All trip units are interchangeable, without wiring. A mechanical mismatch-protection system makes it impossible to mount a trip unit on a circuit breaker with a lower rating.
“Ready” LED for a continuous self-test	The LED on the front of the electronic trip units indicates the result of the self-test running continuously on the measurement system and the tripping release. As long as the green LED is flashing, the links between the CTs, the processing electronics and the tripping mechanism are operational. The circuit breaker is ready to protect. A minimum current of 15 to 50 A, depending on the device, is required for this indication function.
A patented dual adjustment system for protection functions.	Available on Micrologic 5 / 6 trip units, the system consists of: <ul style="list-style-type: none"> • an adjustment using rotary switches sets the maximum value • an adjustment using the keypad or made remotely, fine-tunes the setting. This setting may not exceed the first one. It can be read directly on the Micrologic trip unit screen, to within one ampere and a fraction of a second.

Section 3—Circuit Breakers

Dual-Break Rotating Contacts

All PowerPact™ H-, J-, and L-frame circuit breakers are equipped with dual-break rotating contacts that reduce the amount of peak current during a short circuit fault. This reduces the let-through currents and enhances equipment protection.

Reduced Let-Through Currents

The moving contact has the shape of an elongated “S” and rotates around a floating axis. The shape of the fixed and moving contacts are such that the repelling forces appear as soon as the circuit reaches approximately 15 times I_n .

Due to the rotating movement, repulsion is rapid and the device greatly limits short-circuit currents, whatever the interrupting level of the unit (D, G, J or L). The fault current is extinguished before it can fully develop. Lower let-through currents provide less peak energy, reducing the required bus bar bracing, lowering enclosure pressure, and delivering improved series or combination ratings. See page 23 for UL Current Limiting labels.

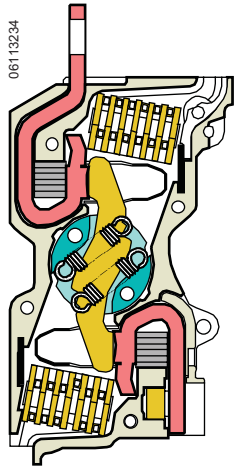

High Ampere Interrupting Ratings (AIR)

Circuit breakers are available with interrupting ratings up to:

- 200 kA at 240 Vac delta
- 200 kA at 480 Vac delta
- 100 kA at 600 Vac delta.

See Table 1 for additional performance levels.

Internal Operating Mechanism

PowerPact H-, J-, and L-frame circuit breakers have an over-center toggle mechanism providing quick-make, quick-break operation. The operating mechanism is also trip-free, which allows tripping even when the circuit breaker handle is held in the “ON” position.

Internal cross-bars provide common opening and closing of all poles with a single operating handle.

All PowerPact circuit breakers have an integral push-to-trip button in the cover to manually trip the circuit breaker. This should be used as part of a regular preventive maintenance program.

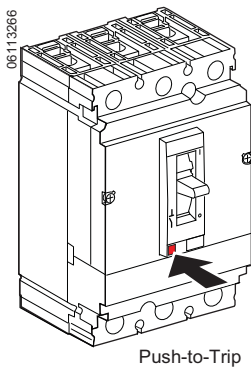

Handle Position Indication

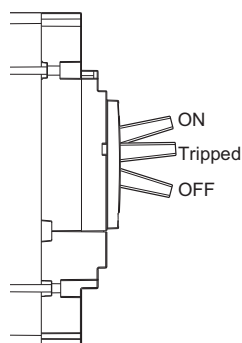

The circuit breaker handle can assume any of three positions, ON, tripped or OFF as shown. The center tripped position provides positive visual indication that the circuit breaker has tripped.

The circuit breaker can be reset by first pushing the handle to the extreme “OFF” position. Power can then be restored to the load by pushing the handle to the “ON” position.

Circuit Breaker Ratings

The interrupting rating is the highest current at rated voltage the circuit breaker is designed to safely interrupt under standard test conditions. Circuit breakers must be selected with interrupting ratings equal to or greater than the available short-circuit current at the point where the circuit breaker is applied to the system (unless it is a branch device in a series rated combination). Interrupting ratings are shown on Table 8: Circuit Breakers on page 19 and on the faceplate label on the front of the circuit breaker.

Reverse Feeding of Circuit Breakers

The standard unit-mount H-, J-, and L-frame circuit breakers have sealed trip units and may be reverse fed. See Tables 14–15 and 28–36 for catalog numbers.

Circuit breakers with field-interchangeable trip units (designated by the suffix T and labeled “LINE” and “LOAD”) cannot be reverse fed. Neither can circuit breaker frames without terminations or trip units.

Current Limiting

The current limiting attributes of PowerPact H-, J-, and L-frame circuit breakers provide greater protection for downstream devices by limiting the let-through current in the event of a fault. The current-limiting capabilities of HJ/HL/HR, JJ/JL/JR, and LJ/LL/LR frame circuit breakers are documented with Underwriters Laboratories and Canadian Standards Association. These current-limiting circuit breakers ship with a label that identifies them as UL/CSA Current Limiting Circuit Breakers. (The HD/HG, JD/JG, and LD/LG circuit breakers do not carry the UL Current Limiting label)

The trip curves with let-through data are available in the trip curve section in this catalog.

Please note that as let-through curves for UL Listed/CSA Certified Current-Limiting Circuit Breakers, these curves are maximum let-through values.

100% Rated

Some models of the H-, J-, and L-frame circuit breakers are UL Listed/CSA Certified to be applied at up to 100% of their current rating. Because of the additional heat generated, the use of specially-designed enclosures, copper lugs on H- and J-frame circuit breakers, and 194°F (90°C) rated wire is required when applying circuit breakers at 100% of continuous current rating. (L-frame circuit breakers can use aluminum or copper lugs.) Markings on the circuit breaker indicate the minimum enclosure size and ventilation required. The 194°F (90°C) wire must be sized according to the ampacities of the 167°F (75°C) wire column in the NEC. Circuit breakers with 100% rating can also be used in applications requiring only standard (80%) continuous loading.

PowerPact™ H-, J-, and L-Frame Circuit Breakers

100% ratings valid for:

- 3P H/J-frame unit mount construction only
- 3P/4P L-frame 250 A and 400 A unit mount construction
- 3P L-frame 250 A and 400 A I-Line™ construction

Corner Grounded Delta Ratings (1Ø-3Ø)

Circuit breakers suitable for corner-grounded circuits are marked 1Ø-3Ø. For additional information, refer to data bulletin 2700DB0202R2/09.

Table 10: Corner Grounded Delta Ratings (1Ø-3Ø)

	2P H-Frame					2P J-Frame				
	HD	HG	HJ ¹	HL ¹	HR ¹	JD ¹	JG ¹	JJ ¹	JL ¹	JR ¹
Ampere Rating (A)	15–150					150–250				
Voltage Rating (Vac)	240					240				
UL Interrupting Rating (kA)	42	42	65	100	200	42	42	65	100	200

¹ Built using 3P module

Figure 2: Three-Phase 240 Vac Corner-Grounded Delta System

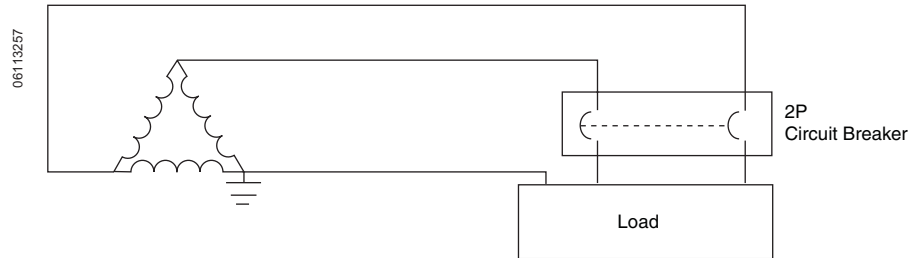

Special Applications

Protection of Industrial Control Panels

PowerPact H-, J-, and L-frame circuit breakers are also used in industrial control panels. They serve as an incoming devices or can be combined with contactors to protect motor feeders:

- compliance with worldwide standards including IEC 60947-2 and UL 508 / CSA C22.2 N°14
- overload and short-circuit protection
- installation in universal and functional type

PowerPact H-, J-, and L-frame circuit breakers equipped for motor protection functions as described in the following pages can be used in industrial control panels. The accessories for the PowerPact H-, J-, and L-frame circuit breakers are suitable for the special needs of these applications.

400 Hz Applications

Micrologic™ 3.2/3, 5.2/3 A or E and 6.2/3 with A or E measurement functions are suitable for 400 Hz. The use of electronics offers the advantage of greater operating stability when the frequency varies. However the units are still subject to temperature rise caused by the frequency.

The practical consequences are:

- limit settings: see the I_r derating table below
- the long-time, short-time and instantaneous pick-ups are not modified (see pages 62 or 64)
- the accuracy of the displayed measurements is 2% (class II).

Table 11: Thermal Derating Maximum I_r Setting

Circuit Breaker	Maximum Setting Coefficient	Max I_r Setting at 400 Hz
H-Frame, 100 A	1	100
J-Frame, 250 A	0.9	225
L-Frame, 400 A	0.8	320
L-Frame, 600 A	0.65	390

Auxiliary Switch (OF) in 400 Hz Networks

Table 12: Electrical Characteristics of Auxiliary Switches

Contact	Standard		Low Level	
	AC12	AC15	AC12	AC15
Utilization cat. (IEC 60947-5-1)				
Operational current	24 V	6 A	6 A	3 A
	40 V	6 A	6 A	3 A
	110 V	6 A	5 A	2.5 A
	200/240 V	6 A	4 A	2 A
	380/415 V	6 A	2 A	1.5 A

Shunt Trip (MX) or Undervoltage Trip (MN) Voltage Release at 400 Hz and 440 V

For circuit breakers on 400 Hz systems, only 125 Vdc undervoltage trip (MN) or shunt trip (MX) releases may be used. The release must be supplied by the 400 Hz system through a rectifier bridge (to be selected from the table below) and an additional resistor with characteristics depending on the system voltage.

Table 13: Rectifier Bridges for MN or MX Releases

Voltage	Rectifier	Additional Resistor
220/240 V	Thomson 110 BHZ or General Instrument W06 or Semikron SKB at 1.2/1.3	4.2 kΩ-5 W
380/240 V	Semikron SKB at 1.2/1.3	10.7 kΩ-10 W

PowerPact™ H-, J-, and L-Frame Circuit Breakers

Circuit Breakers

H- and J-Frame Catalog Numbers

Unit-Mount Circuit Breaker Catalog Numbers

Table 14: PowerPact H-Frame 150 A Unit-Mount¹ Thermal-Magnetic Circuit Breakers (600 Vac, 250 Vdc) with Factory Sealed Trip Unit (Suitable for Reverse Connection)

Current Rating @ 40 C	Fixed AC Magnetic Trip		Interrupting Rating							
			D		G		J ²		L ²	
	Hold	Trip	Standard (80%) Rated	100% Rated ³	Standard (80%) Rated	100% Rated ³	Standard (80%) Rated	100% Rated ³	Standard (80%) Rated	100% Rated ³
H-Frame, 150 A, 2P, 600 Vac 50/60Hz, 250 Vdc⁴										
15 A	350 A	750 A	HDL26015	HDL26015C	HGL26015	HGL26015C	HJL26015	HJL26015C	HLL26015	HLL26015C
20 A	350 A	750 A	HDL26020	HDL26020C	HGL26020	HGL26020C	HJL26020	HJL26020C	HLL26020	HLL26020C
25 A	350 A	750 A	HDL26025	HDL26025C	HGL26025	HGL26025C	HJL26025	HJL26025C	HLL26025	HLL26025C
30 A	350 A	750 A	HDL26030	HDL26030C	HGL26030	HGL26030C	HJL26030	HJL26030C	HLL26030	HLL26030C
35 A	400 A	850 A	HDL26035	HDL26035C	HGL26035	HGL26035C	HJL26035	HJL26035C	HLL26035	HLL26035C
40 A	400 A	850 A	HDL26040	HDL26040C	HGL26040	HGL26040C	HJL26040	HJL26040C	HLL26040	HLL26040C
45 A	400 A	850 A	HDL26045	HDL26045C	HGL26045	HGL26045C	HJL26045	HJL26045C	HLL26045	HLL26045C
50 A	400 A	850 A	HDL26050	HDL26050C	HGL26050	HGL26050C	HJL26050	HJL26050C	HLL26050	HLL26050C
60 A	800 A	1450 A	HDL26060	HDL26060C	HGL26060	HGL26060C	HJL26060	HJL26060C	HLL26060	HLL26060C
70 A	800 A	1450 A	HDL26070	HDL26070C	HGL26070	HGL26070C	HJL26070	HJL26070C	HLL26070	HLL26070C
80 A	800 A	1450 A	HDL26080	HDL26080C	HGL26080	HGL26080C	HJL26080	HJL26080C	HLL26080	HLL26080C
90 A	800 A	1450 A	HDL26090	HDL26090C	HGL26090	HGL26090C	HJL26090	HJL26090C	HLL26090	HLL26090C
100 A	900 A	1700 A	HDL26100	HDL26100C	HGL26100	HGL26100C	HJL26100	HJL26100C	HLL26100	HLL26100C
110 A	900 A	1700 A	HDL26110	HDL26110C	HGL26110	HGL26110C	HJL26110	HJL26110C	HLL26110	HLL26110C
125 A	900 A	1700 A	HDL26125	HDL26125C	HGL26125	HGL26125C	HJL26125	HJL26125C	HLL26125	HLL26125C
150 A	900 A	1700 A	HDL26150	HDL26150C	HGL26150	HGL26150C	HJL26150	HJL26150C	HLL26150	HLL26150C
H-Frame, 150 A, 3P, 600 Vac 50/60Hz, 250 Vdc										
15 A	350 A	750 A	HDL36015	HDL36015C	HGL36015	HGL36015C	HJL36015	HJL36015C	HLL36015	HLL36015C
20 A	350 A	750 A	HDL36020	HDL36020C	HGL36020	HGL36020C	HJL36020	HJL36020C	HLL36020	HLL36020C
25 A	350 A	750 A	HDL36025	HDL36025C	HGL36025	HGL36025C	HJL36025	HJL36025C	HLL36025	HLL36025C
30 A	350 A	750 A	HDL36030	HDL36030C	HGL36030	HGL36030C	HJL36030	HJL36030C	HLL36030	HLL36030C
35 A	400 A	850 A	HDL36035	HDL36035C	HGL36035	HGL36035C	HJL36035	HJL36035C	HLL36035	HLL36035C
40 A	400 A	850 A	HDL36040	HDL36040C	HGL36040	HGL36040C	HJL36040	HJL36040C	HLL36040	HLL36040C
45 A	400 A	850 A	HDL36045	HDL36045C	HGL36045	HGL36045C	HJL36045	HJL36045C	HLL36045	HLL36045C
50 A	400 A	850 A	HDL36050	HDL36050C	HGL36050	HGL36050C	HJL36050	HJL36050C	HLL36050	HLL36050C
60 A	800 A	1450 A	HDL36060	HDL36060C	HGL36060	HGL36060C	HJL36060	HJL36060C	HLL36060	HLL36060C
70 A	800 A	1450 A	HDL36070	HDL36070C	HGL36070	HGL36070C	HJL36070	HJL36070C	HLL36070	HLL36070C
80 A	800 A	1450 A	HDL36080	HDL36080C	HGL36080	HGL36080C	HJL36080	HJL36080C	HLL36080	HLL36080C
90 A	800 A	1450 A	HDL36090	HDL36090C	HGL36090	HGL36090C	HJL36090	HJL36090C	HLL36090	HLL36090C
100 A	900 A	1700 A	HDL36100	HDL36100C	HGL36100	HGL36100C	HJL36100	HJL36100C	HLL36100	HLL36100C
110 A	900 A	1700 A	HDL36110	HDL36110C	HGL36110	HGL36110C	HJL36110	HJL36110C	HLL36110	HLL36110C
125 A	900 A	1700 A	HDL36125	HDL36125C	HGL36125	HGL36125C	HJL36125	HJL36125C	HLL36125	HLL36125C
150 A	900 A	1700 A	HDL36150	HDL36150C	HGL36150	HGL36150C	HJL36150	HJL36150C	HLL36150	HLL36150C

¹ Standard Lug Kit: AL150HD Terminal Wire Range: 14–3/0 AWG Al or Cu

² UL Listed/CSA Certified as current limiting circuit breakers.

³ 100% rated circuit breakers have copper lugs and can be used with copper wire only.

⁴ HD and HG circuit breakers are true 2-pole construction.

PowerPact™ H-, J-, and L-Frame Circuit Breakers Circuit Breakers

Table 15: PowerPact J-Frame 250 A Unit-Mount Thermal-Magnetic Circuit Breakers with Factory Sealed Trip Unit (Suitable for Reverse Connection)

Current Rating @ 40 C	Adjustable AC Magnetic Trip		Interrupting Rating									
			D		G		J ¹		L ¹		R ¹	
	Hold	Trip	Standard (80%) Rated	100% Rated ²	Standard (80%) Rated	100% Rated ²	Standard (80%) Rated	100% Rated ²	Standard (80%) Rated	100% Rated ²	Standard (80%) Rated	100% Rated ²
J-Frame, 250 A, 2P, 600 Vac 50/60Hz, 250 Vdc												
150 A ³	750 A	1500 A	JDL26150	JDL26150C	JGL26150	JGL26150C	JJL26150	JJL26150C	JLL26150	JLL26150C	—	—
175 A ³	875 A	1750 A	JDL26175	JDL26175C	JGL26175	JGL26175C	JJL26175	JJL26175C	JLL26175	JLL26175C	—	—
200 A ⁴	1000 A	2000 A	JDL26200	JDL26200C	JGL26200	JGL26200C	JJL26200	JJL26200C	JLL26200	JLL26200C	—	—
225 A ⁴	1125 A	2250 A	JDL26225	JDL26225C	JGL26225	JGL26225C	JJL26225	JJL26225C	JLL26225	JLL26225C	—	—
250 A ⁴	1250 A	2500 A	JDL26250	JDL26250C	JGL26250	JGL26250C	JJL26250	JJL26250C	JLL26250	JLL26250C	—	—
J-Frame, 250 A, 3P, 600 Vac 50/60Hz, 250 Vdc												
150 A ³	750 A	1500 A	JDL36150	JDL36150C	JGL36150	JGL36150C	JJL36150	JJL36150C	JLL36150	JLL36150C	JRL36150	JRL36150C
175 A ³	875 A	1750 A	JDL36175	JDL36175C	JGL36175	JGL36175C	JJL36175	JJL36175C	JLL36175	JLL36175C	JRL36175	JRL36175C
200 A ⁴	1000 A	2000 A	JDL36200	JDL36200C	JGL36200	JGL36200C	JJL36200	JJL36200C	JLL36200	JLL36200C	JRL36200	JRL36200C
225 A ⁴	1125 A	2250 A	JDL36225	JDL36225C	JGL36225	JGL36225C	JJL36225	JJL36225C	JLL36225	JLL36225C	JRL36225	JRL36225C
250 A ⁴	1250 A	2500 A	JDL36250	JDL36250C	JGL36250	JGL36250C	JJL36250	JJL36250C	JLL36250	JLL36250C	JRL36250	JRL36250C

¹ UL Listed/CSA Certified as current limiting circuit breakers.

² 100% rated circuit breakers have copper lugs and can be used with copper wire only.

³ Standard Lug Kit: AL175JD Terminal Wire Range: 4–4/0 AWG Al or Cu

⁴ Standard Lug Kit: AL250JD Terminal Wire Range: 3/0 AWG–350 kcmil Al or Cu

PowerPact™ H-, J-, and L-Frame Circuit Breakers

Circuit Breakers

Table 16: H-Frame 150 A and J-Frame 250 A Electronic Trip UL Rated Circuit Breakers (600 Vac, 50/60 Hz) With Factory Sealed Trip Unit Suitable for Reverse Connection

Electronic Trip Unit			Sensor Rating	Interrupting Rating				
Type	Function	Trip Unit		D	G	J ¹	L ²	R ²
Standard (80%) Rated Circuit Breakers, 3P								
Standard	LI	3.2 ²	60 A ³	HDL36060U31X	HGL36060U31X	HJL36060U31X	HLL36060U31X	HRL36060U31X
			100 A ³	HDL36100U31X	HGL36100U31X	HJL36100U31X	HLL36100U31X	HRL36100U31X
			150 A ³	HDL36150U31X	HGL36150U31X	HJL36150U31X	HLL36150U31X	HRL36150U31X
			250 A ⁴	JDL36250U31X	JGL36250U31X	JJL36250U31X	JLL36250U31X	JRL36250U31X
Standard	LSI	3.2S ²	60 A ³	HDL36060U33X	HGL36060U33X	HJL36060U33X	HLL36060U33X	HRL36060U33X
			100 A ³	HDL36100U33X	HGL36100U33X	HJL36100U33X	HLL36100U33X	HRL36100U33X
			150 A ³	HDL36150U33X	HGL36150U33X	HJL36150U33X	HLL36150U33X	HRL36150U33X
			250 A ⁴	JDL36250U33X	JGL36250U33X	JJL36250U33X	JLL36250U33X	JRL36250U33X
Ammeter	LSI	5.2A	60 A ³	HDL36060U43X	HGL36060U43X	HJL36060U43X	HLL36060U43X	HRL36060U43X
			100 A ³	HDL36100U43X	HGL36100U43X	HJL36100U43X	HLL36100U43X	HRL36100U43X
			150 A ³	HDL36150U43X	HGL36150U43X	HJL36150U43X	HLL36150U43X	HRL36150U43X
			250 A ⁴	JDL36250U43X	JGL36250U43X	JJL36250U43X	JLL36250U43X	JRL36250U43X
Energy	LSI	5.2E	60 A ³	HDL36060U53X	HGL36060U53X	HJL36060U53X	HLL36060U53X	HRL36060U53X
			100 A ³	HDL36100U53X	HGL36100U53X	HJL36100U53X	HLL36100U53X	HRL36100U53X
			150 A ³	HDL36150U53X	HGL36150U53X	HJL36150U53X	HLL36150U53X	HRL36150U53X
			250 A ⁴	JDL36250U53X	JGL36250U53X	JJL36250U53X	JLL36250U53X	JRL36250U53X
Ammeter	LSIG	6.2A	60 A ³	HDL36060U44X	HGL36060U44X	HJL36060U44X	HLL36060U44X	HRL36060U44X
			100 A ³	HDL36100U44X	HGL36100U44X	HJL36100U44X	HLL36100U44X	HRL36100U44X
			150 A ³	HDL36150U44X	HGL36150U44X	HJL36150U44X	HLL36150U44X	HRL36150U44X
			250 A ⁴	JDL36250U44X	JGL36250U44X	JJL36250U44X	JLL36250U44X	JRL36250U44X
Energy	LSIG	6.2E	60 A ³	HDL36060U54X	HGL36060U54X	HJL36060U54X	HLL36060U54X	HRL36060U54X
			100 A ³	HDL36100U54X	HGL36100U54X	HJL36100U54X	HLL36100U54X	HRL36100U54X
			150 A ³	HDL36150U54X	HGL36150U54X	HJL36150U54X	HLL36150U54X	HRL36150U54X
			250 A ⁴	JDL36250U54X	JGL36250U54X	JJL36250U54X	JLL36250U54X	JRL36250U54X
100% Rated Circuit Breakers, 3P⁵								
Standard	LI	3.2 ²	60 A ³	HDL36060CU31X	HGL36060CU31X	HJL36060CU31X	HLL36060CU31X	HRL36060CU31X
			100 A ³	HDL36100CU31X	HGL36100CU31X	HJL36100CU31X	HLL36100CU31X	HRL36100CU31X
			150 A ³	HDL36150CU31X	HGL36150CU31X	HJL36150CU31X	HLL36150CU31X	HRL36150CU31X
			250 A ⁴	JDL36250CU31X	JGL36250CU31X	JJL36250CU31X	JLL36250CU31X	JRL36250CU31X
Standard	LSI	3.2S ²	60 A ³	HDL36060CU33X	HGL36060CU33X	HJL36060CU33X	HLL36060CU33X	HRL36060CU33X
			100 A ³	HDL36100CU33X	HGL36100CU33X	HJL36100CU33X	HLL36100CU33X	HRL36100CU33X
			150 A ³	HDL36150CU33X	HGL36150CU33X	HJL36150CU33X	HLL36150CU33X	HRL36150CU33X
			250 A ⁴	JDL36250CU33X	JGL36250CU33X	JJL36250CU33X	JLL36250CU33X	JRL36250CU33X
Ammeter	LSI	5.2A	60 A ³	HDL36060CU43X	HGL36060CU43X	HJL36060CU43X	HLL36060CU43X	HRL36060CU43X
			100 A ³	HDL36100CU43X	HGL36100CU43X	HJL36100CU43X	HLL36100CU43X	HRL36100CU43X
			150 A ³	HDL36150CU43X	HGL36150CU43X	HJL36150CU43X	HLL36150CU43X	HRL36150CU43X
			250 A ⁴	JDL36250CU43X	JGL36250CU43X	JJL36250CU43X	JLL36250CU43X	JRL36250CU43X
Energy	LSI	5.2E	60 A ³	HDL36060CU53X	HGL36060CU53X	HJL36060CU53X	HLL36060CU53X	HRL36060CU53X
			100 A ³	HDL36100CU53X	HGL36100CU53X	HJL36100CU53X	HLL36100CU53X	HRL36100CU53X
			150 A ³	HDL36150CU53X	HGL36150CU53X	HJL36150CU53X	HLL36150CU53X	HRL36150CU53X
			250 A ⁴	JDL36250CU53X	JGL36250CU53X	JJL36250CU53X	JLL36250CU53X	JRL36250CU53X

¹ UL Listed/CSA Certified as current limiting circuit breakers.

² 3P circuit breakers with this trip unit can be used for 2P applications.

³ Standard Lug Kit: AL150HD Terminal Wire Range: 14–3/0 AWG Al or Cu

⁴ Standard Lug Kit: AL250JD Terminal Wire Range: 3/0 AWG–350 kcmil Al or Cu
For smaller wire range (4–4/0 AWG Al or Cu), replace the lug's wire binding screws with the larger binding screws provided.

⁵ 100% rated circuit breakers have copper lugs and can be used with copper wire only.

PowerPact™ H-, J-, and L-Frame Circuit Breakers Circuit Breakers

**Table 17: J-Frame 250 A Mission Critical Electronic Trip UL Rated Circuit Breakers
(3P, 480Y/277 Vac, 50/60 Hz) With Factory Sealed Trip Unit Suitable for Reverse Connection**

Electronic Trip Unit			Sensor Rating	Interrupting Rating ¹			
Type	Function	Trip Unit		D	G	J	L
Standard (80%) Rated Circuit Breakers, 3P							
Standard	LI	3.2-W	250 A	JDL34250WU31X	JGL34250WU31X	JJL34250WU31X	JLL34250WU31X
Standard	LSI	3.2S-W	250 A	JDL34250WU33X	JGL34250WU33X	JJL34250WU33X	JLL34250WU33X
Ammeter	LSI	5.2A-W	250 A	JDL34250WU43X	JGL34250WU43X	JJL34250WU43X	JLL34250WU43X
Energy	LSI	5.2E-W	250 A	JDL34250WU53X	JGL34250WU53X	JJL34250WU53X	JLL34250WU53X
Ammeter	LSIG	6.2A-W	250 A	JDL34250WU44X	JGL34250WU44X	JJL34250WU44X	JLL34250WU44X
Energy	LSIG	6.2E-W	250 A	JDL34250WU54X	JGL34250WU54X	JJL34250WU54X	JLL34250WU54X

¹ Standard Lug Kit: AL250JD Terminal Wire Range: 3/0 AWG–350 kcmil Al or Cu
For smaller wire range (4–4/0 AWG Al or Cu), replace the lug's wire binding screws with the larger binding screws provided.

I-Line Circuit Breaker Catalog Numbers

Table 18: PowerPact H-Frame 150 A I-Line Thermal-Magnetic Circuit Breakers¹ with Factory Sealed Trip Unit (Suitable for Reverse Connection)²

Current Rating at 40°C	Fixed AC Magnetic Trip		Interrupting Rating ³ Standard (80%) Rated			
	Hold	Trip	D	G	J ⁴	L ⁴
H-Frame, 150 A, 2P, 600 Vac 50/60Hz, 250 Vdc						
15 A	350 A	750 A	HDA26015()	HGA26015()	HJA26015()	HLA26015()
20 A	350 A	750 A	HDA26020()	HGA26020()	HJA26020()	HLA26020()
25 A	350 A	750 A	HDA26025()	HGA26025()	HJA26025()	HLA26025()
30 A	350 A	750 A	HDA26030()	HGA26030()	HJA26030()	HLA26030()
35 A	400 A	850 A	HDA26035()	HGA26035()	HJA26035()	HLA26035()
40 A	400 A	850 A	HDA26040()	HGA26040()	HJA26040()	HLA26040()
45 A	400 A	850 A	HDA26045()	HGA26045()	HJA26045()	HLA26045()
50 A	400 A	850 A	HDA26050()	HGA26050()	HJA26050()	HLA26050()
60 A	800 A	1450 A	HDA26060()	HGA26060()	HJA26060()	HLA26060()
70 A	800 A	1450 A	HDA26070()	HGA26070()	HJA26070()	HLA26070()
80 A	800 A	1450 A	HDA26080()	HGA26080()	HJA26080()	HLA26080()
90 A	800 A	1450 A	HDA26090()	HGA26090()	HJA26090()	HLA26090()
100 A	900 A	1700 A	HDA26100()	HGA26100()	HJA26100()	HLA26100()
110 A	900 A	1700 A	HDA26110()	HGA26110()	HJA26110()	HLA26110()
125 A	900 A	1700 A	HDA26125()	HGA26125()	HJA26125()	HLA26125()
150 A	900 A	1700 A	HDA26150()	HGA26150()	HJA26150()	HLA26150()
H-Frame, 150 A, 3P, 600 Vac 50/60Hz, 250 Vdc						
15 A	350 A	750 A	HDA36015	HGA36015	HJA36015	HLA36015
20 A	350 A	750 A	HDA36020	HGA36020	HJA36020	HLA36020
25 A	350 A	750 A	HDA36025	HGA36025	HJA36025	HLA36025
30 A	350 A	750 A	HDA36030	HGA36030	HJA36030	HLA36030
35 A	400 A	850 A	HDA36035	HGA36035	HJA36035	HLA36035
40 A	400 A	850 A	HDA36040	HGA36040	HJA36040	HLA36040
45 A	400 A	850 A	HDA36045	HGA36045	HJA36045	HLA36045
50 A	400 A	850 A	HDA36050	HGA36050	HJA36050	HLA36050
60 A	800 A	1450 A	HDA36060	HGA36060	HJA36060	HLA36060
70 A	800 A	1450 A	HDA36070	HGA36070	HJA36070	HLA36070
80 A	800 A	1450 A	HDA36080	HGA36080	HJA36080	HLA36080
90 A	800 A	1450 A	HDA36090	HGA36090	HJA36090	HLA36090
100 A	900 A	1700 A	HDA36100	HGA36100	HJA36100	HLA36100
110 A	900 A	1700 A	HDA36110	HGA36110	HJA36110	HLA36110
125 A	900 A	1700 A	HDA36125	HGA36125	HJA36125	HLA36125
150 A	900 A	1700 A	HDA36150	HGA36150	HJA36150	HLA36150

¹ Standard Lug Kit: AL150HD Terminal Wire Range: 14–3/0 AWG Al or Cu.

² No 100% I-Line available.

³ () Indicates phasing. See "Catalog Numbering" on page 8.

⁴ UL Listed/CSA Certified as current limiting circuit breakers.

PowerPact™ H-, J-, and L-Frame Circuit Breakers Circuit Breakers

Table 19: PowerPact J-Frame 250A I-Line Thermal-Magnetic Circuit Breakers with Factory Sealed Trip Unit (Suitable for Reverse Connection)¹

Current Rating @ 40 C	Adjustable AC Magnetic Trip		Interrupting Rating ² Standard (80%) Rated				
	Hold	Trip	D	G	J ³	L ³	R ³
J-Frame, 250 A, 2P, 600 Vac 50/60Hz, 250 Vdc							
150 A ⁴	750 A	1500 A	JDA26150()	JGA26150()	JJA26150()	—	—
175 A ⁴	875 A	1750 A	JDA26175()	JGA26175()	JJA26175()	—	—
200 A ⁵	1000 A	2000 A	JDA26200()	JGA26200()	JJA26200()	—	—
225 A ⁵	1125 A	2250 A	JDA26225()	JGA26225()	JJA26225()	—	—
250 A ⁵	1250 A	2500 A	JDA26250()	JGA26250()	JJA26250()	—	—
J-Frame, 250 A, 3P, 600 Vac 50/60Hz, 250 Vdc							
150 A ⁴	750 A	1500 A	JDA36150	JGA36150	JJA36150	JLA36150	JRA36150
175 A ⁴	875 A	1750 A	JDA36175	JGA36175	JJA36175	JLA36175	JRA36175
200 A ⁵	1000 A	2000 A	JDA36200	JGA36200	JJA36200	JLA36200	JRA36200
225 A ⁵	1125 A	2250 A	JDA36225	JGA36225	JJA36225	JLA36225	JRA36225
250 A ⁵	1250 A	2500 A	JDA36250	JGA36250	JJA36250	JLA36250	JRA36250

¹ No 100% I-Line available.

² () Indicates phasing. See "Catalog Numbering" on page 8.

³ UL Listed/CSA Certified as current limiting.

⁴ Standard Lug Kit: AL175JD Terminal Wire Range: 4–4/0 AWG Al or Cu.

⁵ Standard Lug Kit: AL250JD Terminal Wire Range: 3/0 AWG–350 kcmil Al or Cu.

PowerPact™ H-, J-, and L-Frame Circuit Breakers

Circuit Breakers

Table 20: H-Frame 150 A and J-Frame 250 A I-Line Standard (80%) Rated Electronic Trip UL Rated Circuit Breakers (3P, 600 Vac, 50/60 Hz) With Factory Sealed Trip Unit Suitable for Reverse Connection ¹

Electronic Trip Unit			Sensor Rating	Interrupting Rating				
Type	Function	Trip Unit		D	G	J ²	L ²	R ²
Standard	LI	3.2 ³	60 A ⁴	HDA36060U31X	HGA36060U31X	HJA36060U31X	HLA36060U31X	HRA36060U31X
			100 A ⁴	HDA36100U31X	HGA36100U31X	HJA36100U31X	HLA36100U31X	HRA36100U31X
			150 A ⁴	HDA36150U31X	HGA36150U31X	HJA36150U31X	HLA36150U31	HRA36150U31
			250 A ^{3, 5}	JDA36250U31X	JGA36250U31X	JJA36250U31X	JLA36250U31X	JRA36250U31X
Standard	LSI	3.2S ³	60 A ⁴	HDA36060U33X	HGA36060U33X	HJA36060U33X	HLA36060U33X	HRA36060U33X
			100 A ⁴	HDA36100U33X	HGA36100U33X	HJA36100U33X	HLA36100U33X	HRA36100U33X
			150 A ⁴	HDA36150U33X	HGA36150U33X	HJA36150U33X	HLA36150U33X	HRA36150U33X
			250 A ^{3, 5}	JDA36250U33X	JGA36250U33X	JJA36250U33X	JLA36250U33X	JRA36250U33X
Ammeter	LSI	5.2A	60 A ⁴	HDA36060U43X	HGA36060U43X	HJA36060U43X	HLA36060U43X	HRA36060U43X
			100 A ⁴	HDA36100U43X	HGA36100U43X	HJA36100U43X	HLA36100U43X	HRA36100U43X
			150 A ⁴	HDA36150U43X	HGA36150U43X	HJA36150U43X	HLA36150U43X	HRA36150U43X
			250 A ^{3, 5}	JDA36250U43X	JGA36250U43X	JJA36250U43X	JLA36250U43X	JRA36250U43X
Energy	LSI	5.2E	60 A ⁴	HDA36060U53X	HGA36060U53X	HJA36060U53X	HLA36060U53X	HRA36060U53X
			100 A ⁴	HDA36100U53X	HGA36100U53X	HJA36100U53X	HLA36100U53X	HRA36100U53X
			150 A ⁴	HDA36150U53X	HGA36150U53X	HJA36150U53X	HLA36150U53X	HRA36150U53X
			250 A ^{3, 5}	JDA36250U53X	JGA36250U53X	JJA36250U53X	JLA36250U53X	JRA36250U53X
Ammeter	LSIG	6.2A	60 A ⁴	HDA36060U44X	HGA36060U44X	HJA36060U44X	HLA36060U44X	HRA36060U44X
			100 A ⁴	HDA36100U44X	HGA36100U44X	HJA36100U44X	HLA36100U44X	HRA36100U44X
			150 A ⁴	HDA36150U44X	HGA36150U44X	HJA36150U44X	HLA36150U44X	HRA36150U44X
			250 A ^{3, 5}	JDA36250U44X	JGA36250U44X	JJA36250U44X	JLA36250U44X	JRA36250U44X
Energy	LSIG	6.2E	60 A ⁴	HDA36060U54X	HGA36060U54X	HJA36060U54X	HLA36060U54X	HRA36060U54X
			100 A ⁴	HDA36100U54X	HGA36100U54X	HJA36100U54X	HLA36100U54X	HRA36100U54X
			150 A ⁴	HDA36150U54X	HGA36150U54X	HJA36150U54X	HLA36150U54X	HRA36150U54X
			250 A ^{3, 5}	JDA36250U54X	JGA36250U54X	JJA36250U54X	JLA36250U54X	JRA36250U54X

¹ No 100% I-Line available.

² UL Listed/CSA Certified as current limiting circuit breakers.

³ 3P circuit breakers with this trip unit can be used for 2P applications.

⁴ Standard Lug Kit: AL150HD Terminal Wire Range: 14–3/0 AWG Al or Cu

⁵ Standard Lug Kit: AL250JD Terminal Wire Range: 3/0 AWG–350 kcmil Al or Cu

For smaller wire range (4–4/0 AWG Al or Cu), replace the lug's wire binding screws with the larger binding screws provided.

Table 21: J-Frame 250 A Mission Critical I-Line Standard (80%) Rated Electronic Trip UL Rated Circuit Breakers (3P, 480Y/277 Vac, 50/60 Hz) With Factory Sealed Trip Unit Suitable for Reverse Connection

Electronic Trip Unit			Sensor Rating	Interrupting Rating ¹ .			
Type	Function	Trip Unit		D	G	J	L
Standard	LI	3.2-W	250 A	JDA34250WU31X	JGA34250WU31X	JJA34250WU31X	JLA34250WU31X
Standard	LSI	3.2S-W	250 A	JDA34250WU33X	JGA34250WU33X	JJA34250WU33X	JLA34250WU33X
Ammeter	LSI	5.2A-W	250 A	JDA34250WU43X	JGA34250WU43X	JJA34250WU43X	JLA34250WU43X
Energy	LSI	5.2E-W	250 A	JDA34250WU53X	JGA34250WU53X	JJA34250WU53X	JLA34250WU53X
Ammeter	LSIG	6.2A-W	250 A	JDA34250WU44X	JGA34250WU44X	JJA34250WU44X	JLA34250WU44X
Energy	LSIG	6.2E-W	250 A	JDA34250WU54X	JGA34250WU54X	JJA34250WU54X	JLA34250WU54X

¹ Standard Lug Kit: AL250JD Terminal Wire Range: 3/0 AWG–350 kcmil Al or Cu

For smaller wire range (4–4/0 AWG Al or Cu), replace the lug's wire binding screws with the larger binding screws provided.

PowerPact™ H-, J-, and L-Frame Circuit Breakers Circuit Breakers

Circuit Breakers with Field-Interchangeable Trip Units Catalog Numbers

Table 22: H-Frame 150 A Circuit Breaker Frame¹ with Field-Interchangeable Thermal-Magnetic Trip Units² (3P, 600 Vac, 250 Vdc)

Ampere Rating	Fixed AC Magnetic Trip		Interrupting Rating			
			D	G	J ³	L ³
	Hold	Trip	Cat. No.	Cat. No.	Cat. No.	Cat. No.
15 A	350 A	750 A	HDL36015T	HGL36015T	HJL36015T	HLL36015T
20 A	350 A	750 A	HDL36020T	HGL36020T	HJL36020T	HLL36020T
25 A	350 A	750 A	HDL36025T	HGL36025T	HJL36025T	HLL36025T
30 A	350 A	750 A	HDL36030T	HGL36030T	HJL36030T	HLL36030T
35 A	400 A	850 A	HDL36035T	HGL36035T	HJL36035T	HLL36035T
40 A	400 A	850 A	HDL36040T	HGL36040T	HJL36040T	HLL36040T
45 A	400 A	850 A	HDL36045T	HGL36045T	HJL36045T	HLL36045T
50 A	400 A	850 A	HDL36050T	HGL36050T	HJL36050T	HLL36050T
60 A	800 A	1450 A	HDL36060T	HGL36060T	HJL36060T	HLL36060T
70 A	800 A	1450 A	HDL36070T	HGL36070T	HJL36070T	HLL36070T
80 A	800 A	1450 A	HDL36080T	HGL36080T	HJL36080T	HLL36080T
90 A	800 A	1450 A	HDL36090T	HGL36090T	HJL36090T	HLL36090T
100 A	900 A	1700 A	HDL36100T	HGL36100T	HJL36100T	HLL36100T
110 A	900 A	1700 A	HDL36110T	HGL36110T	HJL36110T	HLL36110T
125 A	900 A	1700 A	HDL36125T	HGL36125T	HJL36125T	HLL36125T
150 A	900 A	1700 A	HDL36150T	HGL36150T	HJL36150T	HLL36150T

¹ Standard Lug Kit: AL150HD Terminal Wire Range: 14–3/0 AWG Al or Cu.

² Circuit breakers will be labeled with Line and Load markings and are not suitable for reverse connections. Only available on standard (80%) rated 3P unit-mount circuit breakers. Not available in R interrupting rating. Not available with I-Line or Plug-In constructions.

³ UL Listed/CSA Certified as current limiting circuit breakers.

Table 23: J-Frame 250 A Circuit Breaker Frame with Field-Interchangeable Thermal-Magnetic Trip Units¹ (3P, 600 Vac, 250 Vdc)

Ampere Rating	Adjustable AC Magnetic Trip		Interrupting Rating			
			D	G	J ²	L ³
	Low	High	Cat. No.	Cat. No.	Cat. No.	Cat. No.
150 A ³	750 A	1500 A	JDL36150T	JGL36150T	JJL36150T	JLL36150T
175 A ³	875 A	1750 A	JDL36175T	JGL36175T	JJL36175T	JLL36175T
200 A ⁴	1000 A	2000 A	JDL36200T	JGL36200T	JJL36200T	JLL36200T
225 A ⁴	1125 A	2250 A	JDL36225T	JGL36225T	JJL36225T	JLL36225T
250 A ⁴	1250 A	2500 A	JDL36250T	JGL36250T	JJL36250T	JLL36250T

¹ Circuit breakers will be labeled with Line and Load markings and are not suitable for reverse connections. Only available on standard (80%) rated 3P unit-mount circuit breakers. Not available in R interrupting rating. Not available with I-Line™ or Plug-In constructions.

² UL Listed/CSA Certified as current limiting circuit breakers.

³ Standard Lug Kit: AL175JD Terminal Wire Range: 4–4/0 AWG Al or Cu.

⁴ Standard Lug Kit: AL250JD Terminal Wire Range: 3/0 AWG–350 kcmil Al or Cu.

PowerPact™ H-, J-, and L-Frame Circuit Breakers

Circuit Breakers

Table 24: H-Frame 150 A and J-Frame 250 A 3P Circuit Breakers with Lugs and Field-Interchangeable Electronic Trip Units^{1, 2} (Standard (80%) Rated, 600 Vac, 50/60 Hz)

Electronic Trip Unit			Sensor Size	Interrupting Rating			
Type	Function	Trip Unit		D	G	J ³	L ³
Standard	LI	3.2	60 A ⁴	HDL36060TU31X	HGL36060TU31X	HJL36060TU31X	HLL36060TU31X
			100 A ⁴	HDL36100TU31X	HGL36100TU31X	HJL36100TU31X	HLL36100TU31X
			150 A ⁴	HDL36150TU31X	HGL36150TU31X	HJL36150TU31X	HLL36150TU31X
			250 A ⁵	JDL36250TU31X	JGL36250TU31X	JJL36250TU31X	JLL36250TU31X
Standard	LSI	3.2S	60 A ⁴	HDL36060TU33X	HGL36060TU33X	HJL36060TU33X	HLL36060TU33X
			100 A ⁴	HDL36100TU33X	HGL36100TU33X	HJL36100TU33X	HLL36100TU33X
			150 A ⁴	HDL36150TU33X	HGL36150TU33X	HJL36150TU33X	HLL36150TU33X
			250 A ⁵	JDL36250TU33X	JGL36250TU33X	JJL36250TU33X	JLL36250TU33X
Ammeter	LSI	5.2A	60 A ⁴	HDL36060TU43X	HGL36060TU43X	HJL36060TU43X	HLL36060TU43X
			100 A ⁴	HDL36100TU43X	HGL36100TU43X	HJL36100TU43X	HLL36100TU43X
			150 A ⁴	HDL36150TU43X	HGL36150TU43X	HJL36150TU43X	HLL36150TU43X
			250 A ⁵	JDL36250TU43X	JGL36250TU43X	JJL36250TU43X	JLL36250TU43X
Energy	LSI	5.2E	60 A ⁴	HDL36060TU53X	HGL36060TU53X	HJL36060TU53X	HLL36060TU53X
			100 A ⁴	HDL36100TU53X	HGL36100TU53X	HJL36100TU53X	HLL36100TU53X
			150 A ⁴	HDL36150TU53X	HGL36150TU53X	HJL36150TU53X	HLL36150TU53X
			250 A ⁵	JDL36250TU53X	JGL36250TU53X	JJL36250TU53X	JLL36250TU53X
Ammeter	LSIG	6.2A	60 A ⁴	HDL36060TU44X	HGL36060TU44X	HJL36060TU44X	HLL36060TU44X
			100 A ⁴	HDL36100TU44X	HGL36100TU44X	HJL36100TU44X	HLL36100TU44X
			150 A ⁴	HDL36150TU44X	HGL36150TU44X	HJL36150TU44X	HLL36150TU44X
			250 A ⁵	JDL36250TU44X	JGL36250TU44X	JJL36250TU44X	JLL36250TU44X
Energy	LSIG	6.2E	60 A ⁴	HDL36060TU54X	HGL36060TU54X	HJL36060TU54X	HLL36060TU54X
			100 A ⁴	HDL36100TU54X	HGL36100TU54X	HJL36100TU54X	HLL36100TU54X
			150 A ⁴	HDL36150TU54X	HGL36150TU54X	HJL36150TU54X	HLL36150TU54X
			250 A ⁵	JDL36250TU54X	JGL36250TU54X	JJL36250TU54X	JLL36250TU54X

¹ Circuit breakers will be labeled with Line and Load markings and are not suitable for reverse connections.

² Only available on 3P unit-mounted circuit breakers. Not available in R interrupting rating. Not available with I-Line or Plug-in constructions.

³ UL Listed/CSA Certified as current limiting circuit breakers.

⁴ Standard Lug Kit: AL150HD Terminal Wire Range: 14–3/0 AWG Al or C.

⁵ Standard Lug Kit: AL250JD Terminal Wire Range: 3/0 AWG–350 kcmil Al or Cu.

For smaller wire range (4–4/0 AWG Al or Cu), replace the lug's wire binding screws with the larger binding screws provided.

Table 25: H-Frame and J-Frame 3P Field-Installable Thermal-Magnetic Trip Units



15–60 A H-Frame		70–150 A H-Frame		150–250 A J-Frame	
Amperage	Cat. No.	Amperage	Cat. No.	Amperage	Cat. No.
15 A	HT3015	70 A	HT3070	150 A	JT3150
20 A	HT3020	80 A	HT3080	175 A	JT3175
25 A	HT3025	90 A	HT3090	200 A	JT3200
30 A	HT3030	100 A	HT3100	225 A	JT3225
35 A	HT3035	110 A	HT3110	250 A	JT3250
40 A	HT3040	125 A	HT3125	—	—
45 A	HT3045	150 A	HT3150	—	—
50 A	HT3050	—	—	—	—
60 A	HT3060	—	—	—	—

PowerPact™ H-, J-, and L-Frame Circuit Breakers Circuit Breakers

Table 26: H-Frame and J-Frame 3P Field-Installable Micrologic Electronic Trip Units¹

Electronic Trip Unit			Ampere Settings	Trip Unit Cat. No.
Type	Function	Trip Unit		
Standard	LI	3.2	15-20-25-30-35-40-45-50-60	HE3060U31X
			35-40-45-50-60-70-80-90-100	HE3100U31X
			50-60-70-80-90-100-110-125-150	HE3150U31X
			70-80-100-125-150-175-200-225-250	JE3250U31X
Standard	LSI	3.2S	15-20-25-30-35-40-45-50-60	HE3060U33X
			35-40-45-50-60-70-80-90-100	HE3100U33X
			50-60-70-80-90-100-110-125-150	HE3150U33X
			70-80-100-125-150-175-200-225-250	JE3250U33X
Ammeter	LSI	5.2A	15-60	HE3060U43X
			35-100	HE3100U43X
			50-150	HE3150U43X
			70-250	JE3250U43X
Ammeter	LSIG	6.2A	15-60	HE3060U44X
			35-100	HE3100U44X
			50-150	HE3150U44X
			70-250	JE3250U44X
Energy	LSI	5.2E	15-60	HE3060U53X
			35-100	HE3100U53X
			50-150	HE3150U53X
			70-250	JE3250U53X
Energy	LSIG	6.2E	15-60	HE3060U54X
			35-100	HE3100U54X
			50-150	HE3150U54X
			70-250	JE3250U54X

¹ Electronic trip units cannot be used for DC applications.

Table 27: H-Frame 150A and J-Frame 250 A 3P Basic Circuit Breaker Frame Without Terminations or Trip Unit (600 Vac, 250 Vdc¹)

Circuit Breaker Frame	Ampere Rating	Interrupting Rating			
		D	G	J ²	L ²
		Cat. No.	Cat. No.	Cat. No.	Cat. No.
H-Frame ³	15-60 A	HDF36000F06	HGF36000F06	HJF36000F06	HLF36000F06
	70-150 A	HDF36000F15	HGF36000F15	HJF36000F15	HLF36000F15
J-Frame	150-250 A	JDF36000F25	JGF36000F25	JJF36000F25	JLF36000F25

¹ Not suitable for reverse connection.

² UL Listed/CSA Certified as current limiting circuit breakers.

³ Field-installable trip units must match frame ampere rating.

L-Frame Circuit Breaker Catalog Numbers

Unit-Mount Circuit Breaker Catalog Numbers

**Table 28: L-Frame 600 A Electronic Trip UL Rated 3P Circuit Breakers
(600 Vac, 50/60 Hz) With Factory Sealed Trip Unit Suitable for Reverse Connection**

Electronic Trip Unit			Sensor Rating	Interrupting Rating (2nd Letter of Catalog Number)				
Type	Function	Trip Unit		D	G	J ¹	L ¹	R ¹
Standard (80%) Rated, 600 Vac, 50/60 Hz								
Standard	LI	3.3 ²	250 A ³	LDL36250U31X	LGL36250U31X	LJL36250U31X	LLL36250U31X	LRL36250U31X
			400 A ⁴	LDL36400U31X	LGL36400U31X	LJL36400U31X	LLL36400U31X	LRL36400U31X
			600 A ⁴	LDL36600U31X	LGL36600U31X	LJL36600U31X	LLL36600U31X	LRL36600U31X
Standard	LSI	3.3S ²	250 A ³	LDL36250U33X	LGL36250U33X	LJL36250U33X	LLL36250U33X	LRL36250U33X
			400 A ⁴	LDL36400U33X	LGL36400U33X	LJL36400U33X	LLL36400U33X	LRL36400U33X
			600 A ⁴	LDL36600U33X	LGL36600U33X	LJL36600U33X	LLL36600U33X	LRL36600U33X
Ammeter	LSI	5.3A	400 A ⁴	LDL36400U43X	LGL36400U43X	LJL36400U43X	LLL36400U43X	LRL36400U43X
			600 A ⁴	LDL36600U43X	LGL36600U43X	LJL36600U43X	LLL36600U43X	LRL36600U43X
Energy	LSI	5.3E	400 A ⁴	LDL36400U53X	LGL36400U53X	LJL36400U53X	LLL36400U53X	LRL36400U53X
			600 A ⁴	LDL36600U53X	LGL36600U53X	LJL36600U53X	LLL36600U53X	LRL36600U53X
Ammeter	LSIG	6.3A	400 A ⁴	LDL36400U44X	LGL36400U44X	LJL36400U44X	LLL36400U44X	LRL36400U44X
			600 A ⁴	LDL36600U44X	LGL36600U44X	LJL36600U44X	LLL36600U44X	LRL36600U44X
Energy	LSIG	6.3E	400 A ⁴	LDL36400U54X	LGL36400U54X	LJL36400U54X	LLL36400U54X	LRL36400U54X
			600 A ⁴	LDL36600U54X	LGL36600U54X	LJL36600U54X	LLL36600U54X	LRL36600U54X
100% Rated, 600 Vac, 50/60 Hz								
Standard	LI	3.3 ²	250 A ³	LDL36250CU31X	LGL36250CU31X	LJL36250CU31X	LLL36250CU31X	LRL36250CU31X
			400 A ⁴	LDL36400CU31X	LGL36400CU31X	LJL36400CU31X	LLL36400CU31X	LRL36400CU31X
Standard	LSI	3.3S ²	250 A ³	LDL36250CU33X	LGL36250CU33X	LJL36250CU33X	LLL36250CU33X	LRL36250CU33X
			400 A ⁴	LDL36400CU33X	LGL36400CU33X	LJL36400CU33X	LLL36400CU33X	LRL36400CU33X
Ammeter	LSI	5.3A	400 A ⁴	LDL36400CU43X	LGL36400CU43X	LJL36400CU43X	LLL36400CU43X	LRL36400CU43X
Energy	LSI	5.3E	400 A ⁴	LDL36400CU53X	LGL36400CU53X	LJL36400CU53X	LLL36400CU53X	LRL36400CU53X
Ammeter	LSIG	6.3A	400 A ⁴	LDL36400CU44X	LGL36400CU44X	LJL36400CU44X	LLL36400CU44X	LRL36400CU44X
Energy	LSIG	6.3E	400 A ⁴	LDL36400CU54X	LGL36400CU54X	LJL36400CU54X	LLL36400CU54X	LRL36400CU54X

¹ UL Listed/CSA Certified as current limiting circuit breakers.

² 3P circuit breakers with this trip unit can be used for 2P applications.

³ Standard Lug Kit: AL400L61K3 Terminal Wire Range: (1) 2 AWG–600 kcmil Cu or (1) 2 AWG–500 kcmil Al. Type of Terminal Shield: Short.

⁴ Standard Lug Kit: AL600LS52K3 Terminal Wire Range: (2) 2/0 AWG–500 kcmil Al/Cu. Type of Terminal Shield: Medium.

PowerPact™ H-, J-, and L-Frame Circuit Breakers Circuit Breakers

Table 29: L-Frame 600 A Mission Critical Standard (80%) Rated Electronic Trip UL Rated 3P Circuit Breakers (480Y/277 Vac, 50/60 Hz) With Factory Sealed Trip Unit Suitable for Reverse Connection

Electronic Trip Unit			Sensor Rating	Interrupting Rating (2nd Letter of Catalog Number)			
Type	Function	Trip Unit		D	G	J	L
Standard	LI	3.3-W	250 A ¹	LDL34250WU31X	LGL34250WU31X	LJL34250WU31X	LLL34250WU31X
			400 A ²	LDL34400WU31X	LGL34400WU31X	LJL34400WU31X	LLL34400WU31X
			600 A ²	LDL34600WU31X	LGL34600WU31X	LJL34600WU31X	LLL34600WU31X
Standard	LSI	3.3S-W	250 A ¹	LDL34250WU33X	LGL34250WU33X	LJL34250WU33X	LLL34250WU33X
			400 A ²	LDL34400WU33X	LGL34400WU33X	LJL34400WU33X	LLL34400WU33X
			600 A ²	LDL34600WU33X	LGL34600WU33X	LJL34600WU33X	LLL34600WU33X
Ammeter	LSI	5.3A-W	400 A ²	LDL34400WU43X	LGL34400WU43X	LJL34400WU43X	LLL34400WU43X
			600 A ²	LDL34600WU43X	LGL34600WU43X	LJL34600WU43X	LLL34600WU43X
Energy	LSI	5.3E-W	400 A ²	LDL34400WU53X	LGL34400WU53X	LJL34400WU53X	LLL34400WU53X
			600 A ²	LDL34600WU53X	LGL34600WU53X	LJL34600WU53X	LLL34600WU53X
Ammeter	LSIG	6.3A-W	400 A ²	LDL34400WU44X	LGL34400WU44X	LJL34400WU44X	LLL34400WU44X
			600 A ²	LDL34600WU44X	LGL34600WU44X	LJL34600WU44X	LLL34600WU44X
Energy	LSIG	6.3E-W	400 A ²	LDL34400WU54X	LGL34400WU54X	LJL34400WU54X	LLL34400WU54X
			600 A ²	LDL34600WU54X	LGL34600WU54X	LJL34600WU54X	LLL34600WU54X

¹ Standard Lug Kit: AL400L61K3 Terminal Wire Range: (1) 2 AWG–600 kcmil Cu or (1) 2 AWG–500 kcmil Al. Type of Terminal Shield: Short.

² Standard Lug Kit: AL600LS52K3 Terminal Wire Range: (2) 2/0 AWG–500 kcmil Al/Cu. Type of Terminal Shield: Medium.

PowerPact™ H-, J-, and L-Frame Circuit Breakers

Circuit Breakers

Table 30: L-Frame 600 A Electronic Trip UL Rated 4P Circuit Breakers (600 Vac, 50/60 Hz) With Factory Sealed Trip Unit Suitable for Reverse Connection

Electronic Trip Unit			Sensor Rating	Interrupting Rating (2nd Letter of Catalog Number)				
Type	Function	Trip Unit		D	G	J ¹	L ¹	R ¹
Standard (80%) Rated, 600 Vac, 50/60 Hz								
Standard	LI	3.3	250 A ²	LDL46250U31X	LGL46250U31X	LJL46250U31X	LLL46250U31X	LRL46250U31X
			400 A ³	LDL46400U31X	LGL46400U31X	LJL46400U31X	LLL46400U31X	LRL46400U31X
			600 A ³	LDL46600U31X	LGL46600U31X	LJL46600U31X	LLL46600U31X	LRL46600U31X
Standard	LSI	3.3S	250 A ²	LDL46250U33X	LGL46250U33X	LJL46250U33X	LLL46250U33X	LRL46250U33X
			400 A ³	LDL46400U33X	LGL46400U33X	LJL46400U33X	LLL46400U33X	LRL46400U33X
			600 A ³	LDL46600U33X	LGL46600U33X	LJL46600U33X	LLL46600U33X	LRL46600U33X
Ammeter	LSI	5.3A	400 A ³	LDL46400U43X	LGL46400U43X	LJL46400U43X	LLL46400U43X	LRL46400U43X
			600 A ³	LDL46600U43X	LGL46600U43X	LJL46600U43X	LLL46600U43X	LRL46600U43X
Energy	LSI	5.3E	400 A ³	LDL46400U53X	LGL46400U53X	LJL46400U53X	LLL46400U53X	LRL46400U53X
			600 A ³	LDL46600U53X	LGL46600U53X	LJL46600U53X	LLL46600U53X	LRL46600U53X
Ammeter	LSIG	6.3A	400 A ³	LDL46400U44X	LGL46400U44X	LJL46400U44X	LLL46400U44X	LRL46400U44X
			600 A ³	LDL46600U44X	LGL46600U44X	LJL46600U44X	LLL46600U44X	LRL46600U44X
Energy	LSIG	6.3E	400 A ³	LDL46400U54X	LGL46400U54X	LJL46400U54X	LLL46400U54X	LRL46400U54X
			600 A ³	LDL46600U54X	LGL46600U54X	LJL46600U54X	LLL46600U54X	LRL46600U54X
100% Rated, 600 Vac, 50/60 Hz								
Standard	LI	3.3	250 A ²	LDL46250CU31X	LGL46250CU31X	LJL46250CU31X	LLL46250CU31X	LRL46250CU31X
			400 A ³	LDL46400CU31X	LGL46400CU31X	LJL46400CU31X	LLL46400CU31X	LRL46400CU31X
Standard	LSI	3.3S	250 A ²	LDL46250CU33X	LGL46250CU33X	LJL46250CU33X	LLL46250CU33X	LRL46250CU33X
			400 A ³	LDL46400CU33X	LGL46400CU33X	LJL46400CU33X	LLL46400CU33X	LRL46400CU33X
Ammeter	LSI	5.3A	400 A ³	LDL46400CU43X	LGL46400CU43X	LJL46400CU43X	LLL46400CU43X	LRL46400CU43X
Energy	LSI	5.3E	400 A ³	LDL46400CU53X	LGL46400CU53X	LJL46400CU53X	LLL46400CU53X	LRL46400CU53X
Ammeter	LSIG	6.3A	400 A ³	LDL46400CU44X	LGL46400CU44X	LJL46400CU44X	LLL46400CU44X	LRL46400CU44X
Energy	LSIG	6.3E	400 A ³	LDL46400CU54X	LGL46400CU54X	LJL46400CU54X	LLL46400CU54X	LRL46400CU54X

¹ UL Listed/CSA Certified as current limiting circuit breakers.

² Standard Lug Kit: AL400L61K4 Terminal Wire Range: (1) 2 AWG–600 kcmil Cu or (1) 2 AWG–500 kcmil Al. Type of Terminal Shield: Short.

³ Standard Lug Kit: AL600LS52K4 Terminal Wire Range: (2) 2/0 AWG–500 kcmil Al/Cu. Type of Terminal Shield: Medium.

Table 31: L-Frame 600 A Mission Critical Standard (80%) Rated Electronic Trip UL Rated 4P Circuit Breakers (480Y/277 Vac, 50/60 Hz) With Factory Sealed Trip Unit Suitable for Reverse Connection

Electronic Trip Unit			Sensor Rating	Interrupting Rating (2nd Letter of Catalog Number)			
Type	Function	Trip Unit		D	G	J	L
Standard	LI	3.3-W	250 A ¹	LDL44250WU31X	LGL44250WU31X	LJL44250WU31X	LLL44250WU31X
			400 A ²	LDL44400WU31X	LGL44400WU31X	LJL44400WU31X	LLL44400WU31X
			600 A ²	LDL44600WU31X	LGL44600WU31X	LJL44600WU31X	LLL44600WU31X
Standard	LSI	3.3S-W	250 A ¹	LDL44250WU33X	LGL44250WU33X	LJL44250WU33X	LLL44250WU33X
			400 A ²	LDL44400WU33X	LGL44400WU33X	LJL44400WU33X	LLL44400WU33X
			600 A ²	LDL44600WU33X	LGL44600WU33X	LJL44600WU33X	LLL44600WU33X
Ammeter	LSI	5.3A-W	400 A ²	LDL44400WU43X	LGL44400WU43X	LJL44400WU43X	LLL44400WU43X
			600 A ²	LDL44600WU43X	LGL44600WU43X	LJL44600WU43X	LLL44600WU43X
Energy	LSI	5.3E-W	400 A ²	LDL44400WU53X	LGL44400WU53X	LJL44400WU53X	LLL44400WU53X
			600 A ²	LDL44600WU53X	LGL44600WU53X	LJL44600WU53X	LLL44600WU53X
Ammeter	LSIG	6.3A-W	400 A ²	LDL44400WU44X	LGL44400WU44X	LJL44400WU44X	LLL44400WU44X
			600 A ²	LDL44600WU44X	LGL44600WU44X	LJL44600WU44X	LLL44600WU44X
Energy	LSIG	6.3E-W	400 A ²	LDL44400WU54X	LGL44400WU54X	LJL44400WU54X	LLL44400WU54X
			600 A ²	LDL44600WU54X	LGL44600WU54X	LJL44600WU54X	LLL44600WU54X

¹ Standard Lug Kit: AL400L61K4 Terminal Wire Range: (1) 2 AWG–600 kcmil Cu or (1) 2 AWG–500 kcmil Al. Type of Terminal Shield: Short.

² Standard Lug Kit: AL600LS52K4 Terminal Wire Range: (2) 2/0 AWG–500 kcmil Al/Cu. Type of Terminal Shield: Medium.

PowerPact™ H-, J-, and L-Frame Circuit Breakers Circuit Breakers

I-Line Circuit Breaker Catalog Numbers

Table 32: L-Frame 600 A I-Line Standard (80%) Rated Electronic Trip UL Rated Circuit Breakers (600 Vac, 50/60 Hz) With Factory Sealed Trip Unit Suitable for Reverse Connection

Electronic Trip Unit			Sensor Rating	Interrupting Rating				
Type	Function	Trip Unit		D	G	J ¹	L ³	R ³
Standard	LI	3.3 ²	250 A ³	LDA36250U31X	LGA36250U31X	LJA36250U31X	LLA36250U31X	LRA36250U31X
			400 A ⁴	LDA36400U31X	LGA36400U31X	LJA36400U31X	LLA36400U31X	LRA36400U31X
			600 A ⁴	LDA36600U31X	LGA36600U31X	LJA36600U31X	LLA36600U31X	LRA36600U31X
Standard	LSI	3.3S ²	250 A ³	LDA36250U33X	LGA36250U33X	LJA36250U33X	LLA36250U33X	LRA36250U33X
			400 A ⁴	LDA36400U33X	LGA36400U33X	LJA36400U33X	LLA36400U33X	LRA36400U33X
			600 A ⁴	LDA36600U33X	LGA36600U33X	LJA36600U33X	LLA36600U33X	LRA36600U33X
Ammeter	LSI	5.3A	400 A ⁴⁴	LDA36400U43X	LGA36400U43X	LJA36400U43X	LLA36400U43X	LRA36400U43X
			600 A ⁴	LDA36600U43X	LGA36600U43X	LJA36600U43X	LLA36600U43X	LRA36600U43X
Energy	LSI	5.3E	400 A ⁴	LDA36400U53X	LGA36400U53X	LJA36400U53X	LLA36400U53X	LRA36400U53X
			600 A ⁴	LDA36600U53X	LGA36600U53X	LJA36600U53X	LLA36600U53X	LRA36600U53X
Ammeter	LSIG	6.3A	400 A ⁴	LDA36400U44X	LGA36400U44X	LJA36400U44X	LLA36400U44X	LRA36400U44X
			600 A ⁴	LDA36600U44X	LGA36600U44X	LJA36600U44X	LLA36600U44X	LRA36600U44X
Energy	LSIG	6.3E	400 A ⁴	LDA36400U54X	LGA36400U54X	LJA36400U54X	LLA36400U54X	LRA36400U54X
			600 A ⁴	LDA36600U54X	LGA36600U54X	LJA36600U54X	LLA36600U54X	LRA36600U54X

¹ UL Listed/CSA Certified as current limiting circuit breakers.

² 3P circuit breakers with this trip unit can be used for 2P applications.

³ Standard Lug Kit: AL400L61K3 Terminal Wire Range: (1) 2 AWG–600 kcmil Cu or (1) 2 AWG–500 kcmil Al. Type of Terminal Shield: Short.

⁴ Standard Lug Kit: AL600LS52K3 Terminal Wire Range: (2) 2/0 AWG–500 kcmil Al/Cu. Type of Terminal Shield: Medium.

Table 33: L-Frame 600 A Mission Critical I-Line Standard (80%) Rated Electronic Trip UL Rated Circuit Breakers (480/277 Vac, 50/60 Hz) With Factory Sealed Trip Unit Suitable for Reverse Connection

Electronic Trip Unit			Sensor Rating	Interrupting Rating			
Type	Function	Trip Unit		D	G	J	L
Standard	LI	3.3-W	250 A ¹	LDA34250WU31X	LGA34250WU31X	LJA34250WU31X	LLA34250WU31X
			400 A ²	LDA34400WU31X	LGA34400WU31X	LJA34400WU31X	LLA34400WU31X
			600 A ²	LDA34600WU31X	LGA34600WU31X	LJA34600WU31X	LLA34600WU31X
Standard	LSI	3.3S-W	250 A ¹	LDA34250WU33X	LGA34250WU33X	LJA34250WU33X	LLA34250WU33X
			400 A ²	LDA34400WU33X	LGA34400WU33X	LJA34400WU33X	LLA34400WU33X
			600 A ²	LDA34600WU33X	LGA34600WU33X	LJA34600WU33X	LLA34600WU33X
Ammeter	LSI	5.3A-W	400 A ²	LDA34400WU43X	LGA34400WU43X	LJA34400WU43X	LLA34400WU43X
			600 A ²	LDA34600WU43X	LGA34600WU43X	LJA34600WU43X	LLA34600WU43X
Energy	LSI	5.3E-W	400 A ²	LDA34400WU53X	LGA34400WU53X	LJA34400WU53X	LLA34400WU53X
			600 A ²	LDA34600WU53X	LGA34600WU53X	LJA34600WU53X	LLA34600WU53X
Ammeter	LSIG	6.3A-W	400 A ²	LDA34400WU44X	LGA34400WU44X	LJA34400WU44X	LLA34400WU44X
			600 A ²	LDA34600WU44X	LGA34600WU44X	LJA34600WU44X	LLA34600WU44X
Energy	LSIG	6.3E-W	400 A ²	LDA34400WU54X	LGA34400WU54X	LJA34400WU54X	LLA34400WU54X
			600 A ²	LDA34600WU54X	LGA34600WU54X	LJA34600WU54X	LLA34600WU54X

¹ Standard Lug Kit: AL400L61K3 Terminal Wire Range: (1) 2 AWG–600 kcmil Cu or (1) 2 AWG–500 kcmil Al. Type of Terminal Shield: Short.

² Standard Lug Kit: AL600LS52K3 Terminal Wire Range: (2) 2/0 AWG–500 kcmil Al/Cu. Type of Terminal Shield: Medium.

PowerPact™ H-, J-, and L-Frame Circuit Breakers

Circuit Breakers

Table 34: L-Frame 250 A and 400 A I-Line 100% Rated Electronic Trip UL Rated Circuit Breakers (600 Vac, 50/60 Hz) With Factory Sealed Trip Unit Suitable for Reverse Connection

Electronic Trip Unit			Sensor Rating	Interrupting Rating				
Type	Function	Trip Unit		D	G	J ¹	L ³	R ³
Standard	LI	3.3 ²	250 A ³	LDA36250CU31X	LGA36250CU31X	LJA36250CU31X	LLA36250CU31X	LRA36250CU31X
			400 A ⁴	LDA36400CU31X	LGA36400CU31X	LJA36400CU31X	LLA36400CU31X	LRA36400CU31X
Standard	LSI	3.3S ²	250 A ³	LDA36250CU33X	LGA36250CU33X	LJA36250CU33X	LLA36250CU33X	LRA36250CU33X
			400 A ⁴	LDA36400CU33X	LGA36400CU33X	LJA36400CU33X	LLA36400CU33X	LRA36400CU33X
Ammeter	LSI	5.3A	400 A ⁴	LDA36400CU43X	LGA36400CU43X	LJA36400CU43X	LLA36400CU43X	LRA36400CU43X
Energy	LSI	5.3E	400 A ⁴	LDA36400CU53X	LGA36400CU53X	LJA36400CU53X	LLA36400CU53X	LRA36400CU53X
Ammeter	LSIG	6.3A	400 A ⁴	LDA36400CU44X	LGA36400CU44X	LJA36400CU44X	LLA36400CU44X	LRA36400CU44X
Energy	LSIG	6.3E	400 A ⁴	LDA36400CU54X	LGA36400CU54X	LJA36400CU54X	LLA36400CU54X	LRA36400CU54X

¹ UL Listed/CSA Certified as current limiting circuit breakers.

² 3P circuit breakers with this trip unit can be used for 2P applications.

³ Standard Lug Kit: AL400L61K3 Terminal Wire Range: (1) 2 AWG–600 kcmil Cu or (1) 2 AWG–500 kcmil Al. Type of Terminal Shield: Short.

⁴ Standard Lug Kit: AL600LS52K3 Terminal Wire Range: (2) 2/0 AWG–500 kcmil Al/Cu. Type of Terminal Shield: Medium.

Circuit Breakers with Field-Interchangeable Trip Units Catalog Numbers

Table 35: L-Frame 3 Pole, 600 A Circuit Breakers with Lugs and Field-Interchangeable Electronic Trip Units (600 Vac, 50/60 Hz)^{1, 2}

Electronic Trip Unit			Sensor Rating	Interrupting Rating			
Type	Function	Trip Unit		D	G	J ³	L ³
Standard (80% Rated), 600 Vac, 50/60 Hz							
Standard	LI	3.3	250 A ⁴	LDL36250TU31X	LGL36250TU31X	LJL36250TU31X	LLL36250TU31X
			400 A ⁵	LDL36400TU31X	LGL36400TU31X	LJL36400TU31X	LLL36400TU31X
			600 A ⁵	LDL36600TU31X	LGL36600TU31X	LJL36600TU31X	LLL36600TU31X
Standard	LSI	3.3S	250 A ⁴	LDL36250TU33X	LGL36250TU33X	LJL36250TU33X	LLL36250TU33X
			400 A ⁵	LDL36400TU33X	LGL36400TU33X	LJL36400TU33X	LLL36400TU33X
			600 A ⁵	LDL36600TU33X	LGL36600TU33X	LJL36600TU33X	LLL36600TU33X
Ammeter	LSI	5.3A	400 A ⁵	LDL36400TU43X	LGL36400TU43X	LJL36400TU43X	LLL36400TU43X
			600 A ⁵	LDL36600TU43X	LGL36600TU43X	LJL36600TU43X	LLL36600TU43X
Energy	LSI	5.3E	400 A ⁵	LDL36400TU53X	LGL36400TU53X	LJL36400TU53X	LLL36400TU53X
			600 A ⁵	LDL36600TU53X	LGL36600TU53X	LJL36600TU53X	LLL36600TU53X
Ammeter	LSIG	6.3A	400 A ⁵	LDL36400TU44X	LGL36400TU44X	LJL36400TU44X	LLL36400TU44X
			600 A ⁵	LDL36600TU44X	LGL36600TU44X	LJL36600TU44X	LLL36600TU44X
Energy	LSIG	6.3E	400 A ⁵	LDL36400TU54X	LGL36400TU54X	LJL36400TU54X	LLL36400TU54X
			600 A ⁵	LDL36600TU54X	LGL36600TU54X	LJL36600TU54X	LLL36600TU54X
100% Rated, 600 Vac, 50/60 Hz							
Standard	LI	3.3	250 A ⁴	LDL36250RU31X	LGL36250RU31X	LJL36250RU31X	LLL36250RU31X
			400 A ⁵	LDL36400RU31X	LGL36400RU31X	LJL36400RU31X	LLL36400RU31X
Standard	LSI	3.3S	250 A ⁴	LDL36250RU33X	LGL36250RU33X	LJL36250RU33X	LLL36250RU33X
			400 A ⁵	LDL36400RU33X	LGL36400RU33X	LJL36400RU33X	LLL36400RU33X
Ammeter	LSI	5.3A	400 A ⁵	LDL36400RU43X	LGL36400RU43X	LJL36400RU43X	LLL36400RU43X
Energy	LSI	5.3E	400 A ⁵	LDL36400RU53X	LGL36400RU53X	LJL36400RU53X	LLL36400RU53X
Ammeter	LSIG	6.3A	400 A ⁵	LDL36400RU44X	LGL36400RU44X	LJL36400RU44X	LLL36400RU44X
Energy	LSIG	6.3E	400 A ⁵	LDL36400RU54X	LGL36400RU54X	LJL36400RU54X	LLL36400RU54X

¹ Circuit breakers will be labeled with Line and Load markings and are not suitable for reverse connections.

² Only available on 3P unit-mount circuit breakers. Not available in R interrupting rating. Not available with I-Line or Plug-in constructions.

³ UL Listed/CSA Certified as current limiting circuit breakers.

⁴ Standard Lug Kit: AL400L61K3 Terminal Wire Range: (1) 2 AWG–600 kcmil Cu or (1) 2 AWG–500 kcmil Al. Type of Terminal Shield: Short.

⁵ Standard Lug Kit: AL600LS52K3 Terminal Wire Range: (2) 2/0 AWG–500 kcmil Al/Cu. Type of Terminal Shield: Medium.

PowerPact™ H-, J-, and L-Frame Circuit Breakers Circuit Breakers

Table 36: L-Frame 600 A, 3 Pole, Basic Circuit Breaker Frame Without Terminations or Trip Units (600 Vac, 50/60 Hz)¹

Ampere Rating	Interrupting Rating			
	D	G	J ²	L ²
250 A (70–250 A)	LDF36000F25	LGF36000F25	LJF36000F25	LLF36000F25
400 A (125–400 A)	LDF36000F40	LGF36000F40	LJF36000F40	LLF36000F40
600 A (200–600 A)	LDF36000F60	LGF36000F60	LJF36000F60	LLF36000F60

¹ Not suitable for reverse connection.

² UL Listed/CSA Certified as current limiting

Table 37: L-Frame 3P Field-Installable Micrologic Electronic Trip Units

Electronic Trip Unit			Ampere Setting	Trip Unit Cat. No.
Type	Function	Trip Unit		
Standard	LI	3.3	70-80-100-125-150-175-200-225-250 125-150-175-200-225-250-300-350-400 200-225-250-300-350-400-450-500-600	LE3250U31X LE3400U31X LE3600U31X
	LSI	3.3S	70-80-100-125-150-175-200-225-250 125-150-175-200-225-250-300-350-400 200-225-250-300-350-400-450-500-600	LE3250U33X LE3400U33X LE3600U33X
Ammeter	LSI	5.3A	125–400 200–600	LE3400U43X LE3600U43X
	LSIG	6.3A	125–400 200–600	LE3400U44X LE3600U44X
Energy	LSI	5.3E	125–400 200–600	LE3400U53X LE3600U53X
	LSIG	6.3E	125–400 200–600	LE3400U54X LE3600U54X

Section 4—Automatic Switches

Automatic Switch Functions

An automatic switch can be used to open and close a circuit under normal operating conditions. They are similar in construction to circuit breakers, except that the switches open instantaneously at a factory-set, non-adjustable trip point calibrated to protect only the molded case switch.

Molded case switches are intended for use as disconnect devices only. UL489 requires molded case switches to be protected by a circuit breaker or fuse of equivalent rating. Molded case switches are labeled with their appropriate withstand ratings. The withstand rating of a switch is defined as the maximum current at rated voltage that the molded case switch will withstand without damage when protected by a circuit breaker with an equal continuous current rating.

PowerPact™ H-, J-, and L-frame automatic switches are available in unit mount, I-Line™, plug-in and drawout versions. They use the same accessories and offer the same connection possibilities as the circuit-breaker versions. They may be interlocked with another switch or circuit breaker to form a source-changeover system.

Switches are Listed under UL file E103740 and Certified under CSA file LR88980.

Motor Operator

PowerPact H-, J-, and L-frame switches equipped with a motor operator module allow remote closing and opening.

Ground Fault Protection (H- and J-Frame Circuit Breakers Only)

An ELM or GFM module may be added to an automatic switch to monitor all leakage currents in the outgoing circuits of the equipment on which the automatic switch is installed. When the ELM or GFM module detects an earth-leakage current, the automatic switch interrupts the load current.

Automatic Switch Protection

The automatic switch can make and break its rated current. For an overload or a short-circuit, it must be protected by an upstream device, in compliance with installation standards. Due to their high-set instantaneous release PowerPact H-, J- and L-frame automatic switches are self-protected.

Specifications

Table 38: H-Frame Automatic Molded Case Switch Specifications

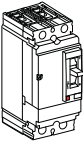
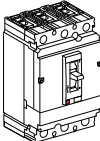
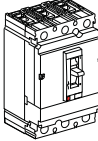
Frame		H-Frame					
Withstand Rating		“G”		“L”			
							
UL 489	Poles	2P	3P	2P ¹	3P		
	Catalog Number	150 A	HGL26000S15	HGL3600S15	HLL26000S15	HLL36000S15	
		175 A	—	—	—	—	
		250 A	—	—	—	—	
	Withstand Ratings	240 Vac	65 kA	65 kA	125 kA	125 kA	
		480 Vac	35 kA	35 kA	100 kA	100 kA	
600 Vac		18 kA	18 kA	50 kA	50 kA		
250 Vdc		20 kA	20 kA	20 kA	20 kA		
AC Trip Point		2250 A	2250 A	2250 A	2250 A		
IEC 60947-3	Rated Insulation Voltage		750 Vac	750 Vac	750 Vac	750 Vac	
	Rated Impulse Withstand Voltage		8 kV	8 kV	8 kV	8 kV	
	Rated Operational Voltage	ac	525 Vac	525 Vac	525 Vac	690 Vac	
		dc	—	—	—	—	

¹ 2P devices use a 3P switch frame with the center pole inoperative.

Table 39: J-Frame Automatic Molded Case Switch Specifications

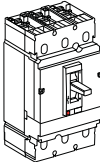
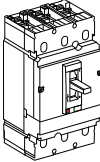
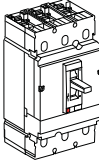
Frame		J-Frame					
Withstand Rating		“G”		“L”		“R”	
							
UL 489	Poles	2P ¹	3P	2P ¹	3P	3P	
	Catalog Number	150 A	—	—	—	—	
		175 A	JGL26000S17	JGL36000S17	JLL26000S17	JLL36000S17	JRL36000S17
		250 A	JGL26000S25	JGL36000S25	JLL26000S25	JLL36000S25	JRL36000S25
	Withstand Ratings	240 Vac	65 kA	65 kA	125 kA	125 kA	200 kA
		480 Vac	35 kA	35 kA	100 kA	100 kA	200 kA
600 Vac		18 kA	18 kA	50 kA	50 kA	100 kA	
250 Vdc		20 kA	20 kA	20 kA	20 kA	20 kA	
AC Trip Point		3125 A	3125 A	3125 A	3125 A	3125 A	
IEC 60947-3	Rated Insulation Voltage		750 Vac	750 Vac	750 Vac	750 Vac	
	Rated Impulse Withstand Voltage		8 kV	8 kV	8 kV	8 kV	
	Rated Operational Voltage	ac	525 Vac	525 Vac	525 Vac	525 Vac	690 Vac
		dc	500 Vdc	500 Vdc	500 Vdc	500 Vdc	500 Vdc

¹ 2P devices use a 3P switch frame with the center pole inoperative.

PowerPact™ H-, J-, and L-Frame Circuit Breakers Automatic Switches

Catalog Numbers

Table 40: PowerPact H-Frame and J-Frame 250 A Unit-Mount Automatic Molded Case Switches, 600 Vac with Factory Sealed Trip Unit (Suitable for Reverse Connection)

Ampere Rating	2-pole	3-pole	Withstand Rating ¹			Trip Point	Standard Lug Kit Terminal Wire Range
	Cat. No.	Cat. No.	240 Vac	480 Vac	600 Vac		
G Withstand							
150 A	HGL26000S15 ²	HGL36000S15	65	35	18	2250 A	AL150HD #14–#3/0 AWG Al or Cu
175 A	JGL26000S17	JGL36000S17	65	35	18	3125 A	AL250JD #3/0–350 kcmil Al or Cu
250 A	JGL26000S25	JGL36000S25					
L Withstand							
150 A	HLL26000S15	HLL36000S15	125	100	50	2250 A	AL150HD #14–#3/0 AWG Al or Cu
175 A	JLL26000S17	JLL36000S17	125	100	50	3125 A	AL250JD #3/0–350 kcmil Al or Cu
250 A	JLL26000S25	JLL36000S25					
R Withstand							
175 A	—	JRL36000S17	200	200	100	3125 A	AL250JD #3/0–350 kcmil Al or Cu
250 A	—	JRL36000S25					

¹ The withstand rating is the fault current, at rated voltage, that the molded case switch will withstand without damage when protected by a circuit breaker or fuse with an equal continuous current rating.

² 2-pole device with 3 in. (76 mm) mounting height, all other 2-pole circuit breakers use 3-pole switch 4.5 in. (114 mm) mounting height.

Table 41: PowerPact H-Frame and J-Frame I-Line Automatic Molded Case Switches, 600 Vac with Factory Sealed Trip Unit (Suitable for Reverse Connection)

Ampere Rating	2-pole	3-pole	Withstand Rating ¹			Trip Point	Standard Lug Kit Terminal Wire Range
	Cat. No.	Cat. No.	240 Vac	480 Vac	600 Vac		
G Withstand							
150 A	HGA26000S15() ²	HGA36000S15	65	35	18	1300 A	AL150HD #14–#3/0 AWG Al or Cu
175 A	JGA26000S17()	JGA36000S17	65	35	18	2500 A	AL250JD #3/0–350 kcmil Al or Cu
250 A	JGA26000S25()	JGA36000S25					
L Withstand							
150 A	HLA26000S15()	HLA36000S15	125	100	50	1300 A	AL150HD #14–#3/0 AWG Al or Cu
175 A	JLA26000S17()	JLA36000S17	125	100	50	1300 A	AL250JD #3/0–350 kcmil Al or Cu
250 A	JLA26000S25()	JLA36000S25				2500 A	
R Withstand							
175 A	JRA26000S17()	JRA36000S17	200	200	100	3125A	AL250JD #3/0–350 kcmil Al or Cu
250 A	JRA26000S25()	JRA36000S25					

¹ The withstand rating is the fault current, at rated voltage, that the molded case switch will withstand without damage when protected by a circuit breaker or fuse with an equal continuous current rating.

² 2-pole device with 3 in. (76 mm) mounting height, all other 2-pole circuit breakers use 3-pole 4.5 in. (114 mm) mounting height.

PowerPact™ H-, J-, and L-Frame Circuit Breakers Automatic Switches

Table 42: PowerPact L-Frame 600 A Unit-Mount Automatic Molded Case Switches, 600 Vac

Ampere Rating	Poles ¹	Cat. No.	Withstand Rating ²			Trip Point	Standard Lug Terminal Wire Range
			240 Vac	480 Vac	600 Vac		
Unit-Mount Automatic Molded Case Switches,							
G Withstand							
400 A	3P	LGL36000S40X	65 kA	35 kA	18 kA	4800 A	AL600LS52K3
600 A		LGL36000S60X	65 kA	35 kA	18 kA	6600 A	(2) 2 AWG–500 kcmil Al/Cu
400 A	4P	LGL46000S40X	65 kA	35 kA	18 kA	4800 A	AL600LS52K4
600 A		LGL46000S60X	65 kA	35 kA	18 kA	6600 A	(2) 2 AWG–500 kcmil Al/Cu
L Withstand							
400 A	3P	LLL36000S40X	125 kA	100 kA	50 kA	4800 A	AL600LS52K3
600 A		LLL36000S60X	125 kA	100 kA	50 kA	6600 A	(2) 2 AWG–500 kcmil Al/Cu
400 A	4P	LLL46000S40X	125 kA	100 kA	50 kA	4800 A	AL600LS52K4
600 A		LLL46000S60X	125 kA	100 kA	50 kA	6600 A	(2) 2 AWG–500 kcmil Al/Cu
R Withstand							
400 A	3P	LRL36000S40X	200 kA	200 kA	100 kA	4800 A	AL600LS52K3
600 A		LRL36000S60X	200 kA	200 kA	100 kA	6600 A	(2) 2 AWG–500 kcmil Al/Cu
400 A	4P	LRL46000S40X	200 kA	200 kA	100 kA	4800 A	AL600LS52K4
600 A		LRL46000S60X	200 kA	200 kA	100 kA	6600 A	(2) 2 AWG–500 kcmil Al/Cu
I-Line Circuit Breakers Automatic Molded Case Switches							
G Withstand							
400 A	3P	LGA36000S40X	65 kA	35 kA	18 kA	4800 A	AL600LF52K3
600 A		LGA36000S60X	65 kA	35 kA	18 kA	6600 A	(2) 3/0 AWG–500 kcmil Al/Cu
L Withstand							
400 A	3P	LLA36000S40X	125 kA	100 kA	50 kA	4800 A	AL600LF52K3
600 A		LLA36000S60X	125 kA	100 kA	50 kA	6600 A	(2) 3/0 AWG–500 kcmil Al/Cu
R Withstand							
400 A	3P	LRA36000S40X	200 kA	200 kA	100 kA	4800 A	AL600LF52K3
600 A		LRA36000S60X	200 kA	200 kA	100 kA	6600 A	(2) 3/0 AWG–500 kcmil Al/Cu

¹ 4P circuit breaker available as bus connected, with lug configurations, and in plug-in, draw-out and rear-connected configurations.

² The withstand rating is the fault current, at rated voltage, that the molded case switch will withstand without damage when protected by a circuit breaker or fuse with an equal continuous current rating.

Table 43: L-Frame Ratings and Withstand Ratings

Circuit Breaker			400 A	600 A
Number of Poles			3, 4	3, 4
Ampere Rating (A)			400	600
UL 489 Ratings				
Rated Voltage (V)			600	600
IEC 60947-3 ratings				
Rated Insulation Voltage (V)			750	750
Rated Impulse Withstand Voltage (kV)			8	8
Rated Operational Voltage	Ue	AC 50/60 Hz	690	690
Rated Operational Current	Ie	AC 525 V	400	600
Making Capacity (kA peak)			7.1	8.5
Short-Time Withstand Current (kA rms)	Icw	Icw (kA ms)	5	6
		Duration (s)	1	1

Section 5—Motor Circuit Protection

General Information

The parameters to be considered for motor-feeder protection depend on:

- the application (type of machine driven, operating safety, frequency of operation, etc.)
- the level of continuity of service required by the load or the application
- the applicable standards for the protection of equipment.

The required electrical functions are:

- isolation
- switching, generally at high endurance levels
- protection against overloads and short-circuits, adapted to the motor
- additional special protection.

A motor branch circuit must comply with the requirements of standard UL508 concerning contactors and their protection:

- coordination of feeder components
- overload relay trip classes.

Motor Branch Circuit Protection Function

A motor branch circuit comprises a set of devices for motor protection and control, as well as for protection of the branch circuit itself.

Switching

The purpose is to control the motor (ON / OFF), either manually, automatically or remotely, taking into account overloads upon start-up and the long service life required. This function is provided by a contactor. When the coil of the contactor's electromagnet is energized, the contactor closes and establishes, through the poles, the circuit between the upstream supply and the motor, through the circuit breaker.

Basic Protection

- Short-circuit protection
Detection and breaking, as quickly as possible, of high short-circuit currents to avoid damage to the installation. This function is provided by a circuit breaker.
- Overload protection
Detection of overload currents and motor shutdown before temperature rise in the motor and conductors damages insulation. This function is provided by a circuit breaker or a separate motor overload relay.
- Phase unbalance or phase loss protection
Phase unbalance or phase loss can cause temperature rise and braking torques that can lead to premature ageing of the motor. These effects are even greater during starting, therefore protection must be virtually immediate.

Additional Electronic Protection

- Locked rotor
- Under-load
- Long starts and stalled rotor
- Insulation faults

Trip Class of an Overload Relay Device

The motor branch circuit includes thermal protection that may be built into the circuit breaker. The protection must have a trip class suited to motor starting. Depending on the application, the motor starting time varies from a few seconds (no-load start) to a few dozen seconds (high-inertia load).

Table 44: Trip Class of Overload Relays as a Function of Their FLA Setting

Class	1.05 FLA ¹	1.2 FLA ¹	1.5 FLA ²	6.0 FLA ¹
5	t > 2 h	t < 2h	t < 2 mn	2 s < t ≤ 5 s
10	t > 2 h	t < 2h	t < 4 mn	4 s < t ≤ 10 s
20	t > 2 h	t < 2h	t < 8 mn	6 s < t ≤ 20 s

¹ Time for a cold start (motor off and cold).

² Time for warm start (motor running under normal conditions).

Example: In class 20, the motor must have finished starting within 20 seconds (6 to 20 s) for a starting current of 6 x FLA.

Asynchronous-Motor Starting Parameters

The main parameters of direct on-line starting of three-phase asynchronous motors (90% of all applications) are listed below.

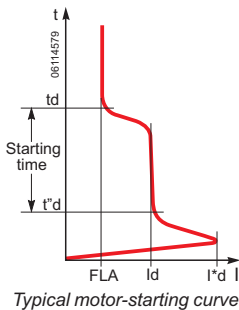

- FLA: Full load amperes
This is the current drawn by the motor at full rated load.
- I_d: locked rotor current
This is the current drawn by the motor during starting, on average 6.0 x I_n for a duration of 5 to 30 seconds depending on the application. These values determine the trip class and any additional “long-start” protection devices that may be needed.
- I_d: peak starting current
This is the subtransient current during the first two half-waves when the system is energized, on the average 14 I_n for 10 to 15 ms (e.g. 1840 A peak).

The protection settings must effectively protect the motor, notably through a suitable overload relay trip class, but let the peak starting current through.

Motor-Feeder Solutions

PowerPact™ H-, J-, and L-frame circuit breakers motor circuit breakers are designed for motor-feeder solutions using:

- three devices, including an electronic MCP or 1.3 M instantaneous-only trip unit
- two devices including a 2 M electronic trip unit.

PowerPact™ H-, J-, and L-Frame Circuit Breakers Motor Circuit Protection

PowerPact H-, J-, and L-Frame with Micrologic™ Trip Units Motor-Protection Range

PowerPact H-, J-, and L-frame circuit breakers with Micrologic trip units can be used to create motor-feeder solutions comprising two or three devices. The protection devices are designed for continuous duty at 104°F (40°C).

Three-device solutions

- 1 PowerPact circuit breaker with Micrologic 1.3 M trip unit
- 1 contactor
- overload relay

Two-device solutions

- 1 PowerPact circuit breaker with a Micrologic 2 M electronic trip unit.
- 1 contactor

Table 45: Motor Protection Specifications

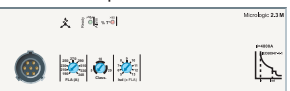
Type of Motor Protection		3 Devices (Circuit Breaker + Contactor + Overload Relay)	2 Devices (Circuit Breaker + Contactor)
PowerPact H-, J-, or L-frame circuit breaker		PowerPact L-frame 400/600 A	PowerPact H-, J-, and L-Frame 100–600 A
	Type 2 coordination with	Contactor + overload relay	Contactor
Trip Unit	Type	Micrologic 1.3 M Electronic Trip Unit 	Micrologic 2 M Electronic Trip Unit 
	Overload Relay		
	Separate	X	
	Built-in, Class	5	X
		10	X
		20	X
Protection functions of PowerPact H-, J-, and L-frame circuit breaker			
Short-circuits		X	X
Overloads			X
Special motor functions	Phase unbalance		X

PowerPact™ H-, J-, and L-Frame Circuit Breakers Motor Circuit Protection

Electronic Motor Circuit Protectors (AC Only)



PowerPact H- and J-frame Electronic Motor Circuit Protectors (MCP) are instantaneous-trip circuit breakers. They are designed to offer short circuit protection and are National Electrical Code® (NEC®) compliant when installed as part of a combination controller having motor overload protection. MCP circuit breakers accept the same accessories and terminals as the equivalent thermal-magnetic circuit breakers. (See Section 3 for Accessories.)

The unique design of the PowerPact MCPs includes two rotary switches to allow quick setting adjustments based on the characteristics of the motor.

The first rotary switch allows for Full Load Amperes (FLA) adjustment across the range of the frame size.

The second rotary switch selects the type of motor protection based on Automatic 1 for Standard Efficiency or Automatic 2 for High Energy Efficient. When using the automatic settings the MCP microprocessor automatically adjusts the trip settings for both current and time to align with the start-up characteristic for the motor type, whether it is a standard or energy-efficient motor. This includes a dampening means to accommodate a transient motor in-rush current without nuisance tripping of the circuit breaker. Rotary switch 2 also allows for traditional motor protection from 8 to 13 times the selected FLA.

The MCP rotary switches are detented and allow the device to be set to specific trip values within a typical accuracy range of +/-5%.

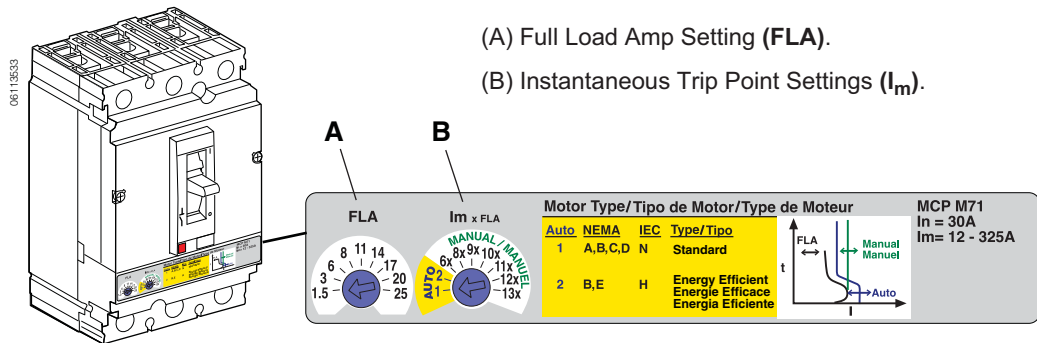

Full Load Amp Settings

1. Determine the motor's full-load current by referring to the nameplate on the motor.
2. Set the trip range by turning the FLA rotary switch to the setting closest to the motor's full load current.

Automatic Protection Settings

The MCP microprocessor automatically adjusts the trip settings for both current and time to align with the start-up characteristics for the motor type selected. This includes a dampening means to accommodate a transient motor in-rush current without nuisance tripping of the circuit breaker.

PowerPact™ H-, J-, and L-Frame Circuit Breakers Motor Circuit Protection

Figure 3: Automatic Protection Settings

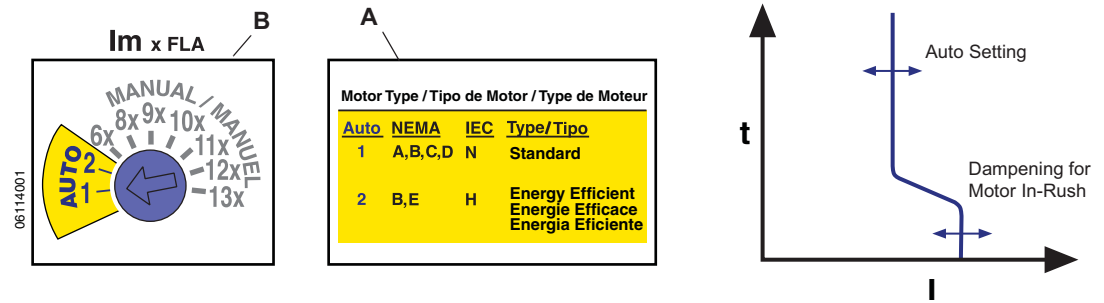

Manual Protection Settings

The manual settings may be adjusted to multiples of current based on the rotary switch setting for motor Full Load Amps (FLA).

$$\text{Instantaneous Trip Point} = (\text{FLA}) \times (I_m)$$

For example, if FLA rotary switch is set to 20 and I_m rotary switch is set to 9x, then the instantaneous trip point will be 180 A.

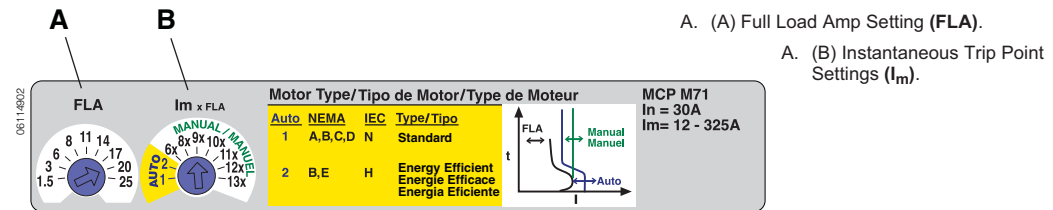

See Tables 51 thru 53 for more information.

Table 46: H- and J-Frame Electronic Motor Circuit Protectors (MCP)

Frame	Current	Full Load Amperes Range	Adjustable Instantaneous Trip Range	Suffix	J Interrupting (See SCCR Table Below)	L Interrupting (See SCCR Table Below)	R Interrupting
					Cat. No.	Cat. No.	Cat. No.
H-Frame	30 A	1.5–25 A	9–325 A	M71	HJL36030M71	HLL36030M71	HRL36030M71
	50 A	14–42 A	84–546 A	M72	HJL36050M72	HLL36050M72	HRL36050M72
	100 A	30–80 A	180–1040 A	M73	HJL36100M73	HLL36100M73	HRL36100M73
	150 A	58–130 A	348–1690 A	M74	HJL36150M74	HLL36150M74	HRL36150M74
J-Frame	250 A	114–217 A	684–2500 A	M75	JJL36250M75	JLL36250M75	JRL36250M75

- High Short Circuit Current Ratings (SCCR)
The PowerPact MCP helps achieve the high UL508A Short Circuit Current Rating (SCCR) needed to meet NEC Article 409 requirements for industrial control panels. They deliver up to 100 kA at 480 Vac SCCR when used in combination with approved Square D™ NEMA or Schneider Electric™ IEC motor starters.

Table 47: Short Circuit Current Ratings (SCCR)

Contactor/Starter	J Interrupting			L Interrupting			R Interrupting		
	200–240 Vac	480 Vac	600 Vac	200–240 Vac	480 Vac	600 Vac	200–240 Vac	480 Vac	600 Vac
Tesys D-line and F-line	100 kA	65 kA	25 kA	100 kA	100 kA	50 kA	200 kA	200 kA	100 kA
NEMA Type S	100 kA	65 kA	25 kA	100 kA	100 kA	50 kA	200 kA	200 kA	100 kA

PowerPact™ H-, J-, and L-Frame Circuit Breakers Motor Circuit Protection

Table 48: MCP Selection by HP Ratings of Induction-Type Squirrel-Cage and Wound-Rotor Motors

Horsepower Rating of Induction-Type Squirrel-Cage and Wound-Rotor Motors 3Ø 60 Hz					NEC Full Load Amperes	PowerPact H-Frame and J-Frame Electronic MCP		
Starter Size	200 Vac	230 Vac	480 Vac	575 Vac				
00	1/2	1/2	1/2	1/2	0.9 A	HJL36030M71 and HLL36030M71 1/2–10 hp		
			3/4	3/4	1.1 A			
			1	1	1.3 A			
			1	1	1.7 A			
			1	1	2.1 A			
			1	1	2.2 A			
			1	1	2.4 A			
	3/4	3/4	3/4	1-1/2	1-1/2			2.5 A
				2	2			2.7 A
				2	2			3 A
				2	2			3.2 A
				2	2			3.4 A
				2	2			3.7 A
				2	2			3.9 A
1	1	1	3	3	4.2 A			
			3	3	4.8 A			
			3	3	4.8 A			
			3	3	6 A			
			3	3	6.1 A			
			3	3	6.8 A			
			3	3	6.9 A			
1-1/2	1-1/2	1-1/2	5	5	7.6 A			
			5	5	7.8 A			
			5	5	9 A			
			5	5	9.6 A			
			5	5	11 A			
			5	5	14 A			
			5	5	15.2 A			
0	2	3	7-1/2	7-1/2	17 A			
			10	10	17.5 A			
			10	10	21 A			
			10	10	22 A			
			10	10	25.3 A			
			10	10	27 A			
			10	10	28 A			
1	5	5	15	15	32 A			
			15	15	32.2 A			
			15	15	34 A			
			15	15	40 A			
			15	15	41 A			
			15	15	42 A			
			15	15	48.3 A			
2	7-1/2	7-1/2	20	20	52 A			
			20	20	54 A			
			20	20	62 A			
			20	20	65 A			
			20	20	68 A			
			20	20	77 A			
			20	20	78.2 A			
3	10	10	25	25	80 A			
			25	25	92 A			
			25	25	96 A			
			25	25	99 A			
			25	25	104 A			
			25	25	120 A			
			25	25	124 A			
4	15	15	30	30	125 A			
			30	30	130 A			
			30	30	144 A			
			30	30	150 A			
			30	30	154 A			
			30	30	156 A			
			30	30	177.1 A			
5	20	20	40	40	180 A			
			40	40	192 A			
			40	40	221 A			
			40	40	240 A			
			40	40	248 A			
			40	40				
			40	40				
3	25	25	50	50				
			50	50				
			50	50				
			50	50				
			50	50				
			50	50				
			50	50				
4	30	30	60	60				
			60	60				
			60	60				
			60	60				
			60	60				
			60	60				
			60	60				
5	40	40	75	75				
			75	75				
			75	75				
			75	75				
			75	75				
			75	75				
			75	75				
5	50	50	100	100				
			100	100				
			100	100				
			100	100				
			100	100				
			100	100				
			100	100				
5	60	60	125	125				
			125	125				
			125	125				
			125	125				
			125	125				
			125	125				
			125	125				
5	75	75	150	150				
			150	150				
			150	150				
			150	150				
			150	150				
			150	150				
			150	150				
5	100	100	200	200				
			200	200				
			200	200				
			200	200				
			200	200				
			200	200				
			200	200				

Shaded area is not covered by J-frame electronic motor circuit protector.

Micrologic 1.3 M Electronic Trip Units for Instantaneous Protection Only (L-Frame Circuit Breakers Only)

Micrologic 1.3 M trip units are used in 3-device motor-feeder solutions on PowerPact L-frame circuit breakers with performance levels G/J/L. They provide short-circuit protection for motors up to 250 kW at 400 V.

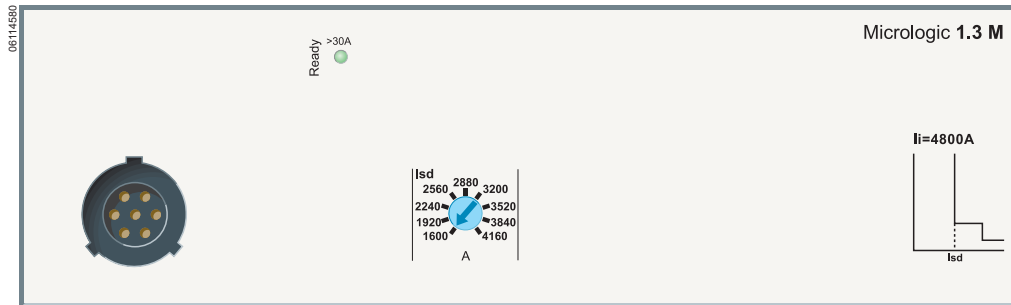

Micrologic 1.3 M trip units provide instantaneous protection only, using electronic technology. They are dedicated to 600 A 3-pole (3P 3D) circuit breakers or 4-pole circuit breakers with detection on three poles (4P, 3D). They are especially used in 3-pole versions for motor protection.

Circuit breakers equipped with Micrologic 1.3 M trip units, without thermal protection, are used in certain applications to replace automatic switches. Micrologic 1.3 M trip units are available on PowerPact L-frame circuit breakers only.

NOTE: All Micrologic trip units have a transparent, sealable cover that protects access to the adjustment rotary switches.

They also provide the benefits of electronic technology:

- accurate settings
- tests
- “Ready” LED.

Circuit breakers with a Micrologic 1.3 M trip unit are combined with an overload relay and a contactor. Protection settings are made using a rotary switch.

Protection Version

Three pole (3P): three pole frame circuit breakers equipped with detection on all three poles.

Indications

The green “Ready” LED blinks slowly when the electronic trip unit is ready to provide protection. It indicates the trip unit is operating correctly.

NOTE: All the trip units have a transparent sealable cover that protects access to the adjustment rotary switches.

PowerPact™ H-, J-, and L-Frame Circuit Breakers Motor Circuit Protection

Table 49: Micrologic 1.3 M Electronic Trip Unit

Rating: I_n at 104°F (40°C) ¹		400 A	600 A
Circuit Breaker	PowerPact L-frame	X	X
Short-time protection			
Pick-up (A) accuracy ±15%	I_{sd} There is a very short delay to let through motor starting currents	Adjustable directly in amps	
		9 settings: 2000-2400-2800-3200-3600-4000-4800 A	9 settings: 3000-3600-4200-4800-5400-6000-6600-7200 A
Time delay (ms)	t_{sd}	Non-adjustable	
	Non-tripping time Maximum break time	20 60	
Instantaneous protection			
Pick-up (A) accuracy ±15%	I_i non-adjustable	4800	7200
	Non-tripping time Maximum break time	0 30 ms	

¹ Motor standards require operation at 104°F (40°C). Circuit-breaker ratings are derated to take this requirement into account

Micrologic 2.2 M and 2.3 M Electronic Trip Units

Micrologic 2.2 M and 2.3 M trip units provide built-in thermal and instantaneous protection. They are used in 2-device motor-feeder solutions on PowerPact H-, J-, and L-frame circuit breakers with performance levels J/L. They provide protection for motors up to 315 kW at 400 V against:

- short-circuits
- overloads with selection of a trip class (5, 10 or 20)
- phase unbalance.

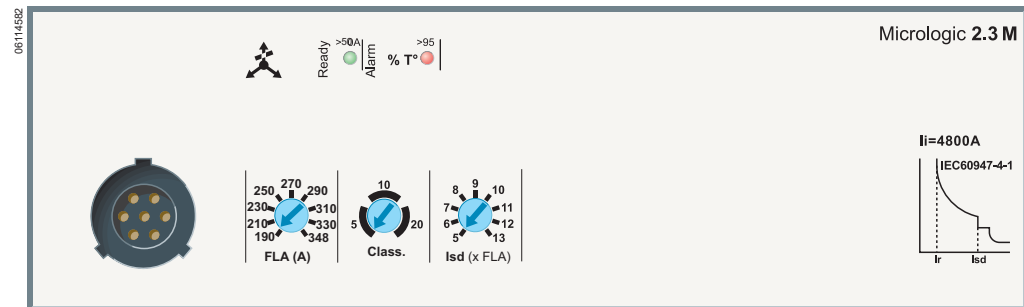

Circuit breakers with a Micrologic 2.2 M/ 2.3 M trip unit include protection similar to an inverse-time overload relay. They are combined with a contactor.

Protection settings are made using a rotary switch.

Overloads (or Thermal Protection)

Long-time protection and trip class (FLA)

- Inverse-time thermal protection
- against overloads with adjustable pick-up FLA.
- Settings are made in amperes. The tripping curve for the long-time protection, which indicates the time delay t_r before tripping, is defined by the selected trip class.

PowerPact™ H-, J-, and L-Frame Circuit Breakers

Motor Circuit Protection

Trip Class

- The class is selected as a function of the normal motor starting time.
 - Class 5: starting time less than 5 s
 - Class 10: starting time less than 10 s
 - Class 20: starting time less than 20 s
- For a given class, it is necessary to check that all motor-feeder components are sized to carry the 6 x FLA starting current without excessive temperature rise during the time corresponding to the class.

Short-Circuits

Short-time protection (I_{sd})

- Provides protection with an adjustable pick-up I_{sd} .
- There is a very short delay to let through motor starting currents.

Non-adjustable instantaneous protection (I_i)

- Instantaneous protection with non-adjustable pick-up I_i .

Phase Unbalance or Phase Loss (I_{unbal})

- This function opens the circuit breaker if a phase unbalance occurs:
 - that is greater than the 30% fixed pick-up I_{unbal}
 - following the non-adjustable time delay t_{unbal} equal to:
 - 0.7 s during starting
 - 4 s during normal operation
- Phase loss is an extreme case of phase unbalance and leads to tripping under the same conditions

Indications

Front indications

- The green “Ready” LED blinks slowly when the electronic trip unit is ready to provide protection. It indicates the trip unit is operating correctly.
- Red alarm LED for motor operation goes ON when the thermal image of the rotor and stator is greater than 95% of the permissible temperature rise.

Remote indications using SDTAM module

- PowerPact H-, J-, and L-frame devices with a Micrologic 2 M trip unit can be equipped with an SDTAM module dedicated to motor applications for:
 - a contact to indicate circuit-breaker overload
 - a contact to open the contactor. In the event of a phase unbalance or overload, this output is activated 400 ms before circuit-breaker tripping to open the contactor and avoid circuit breaker tripping
- This module takes the place of the shunt trip (MN)/undervoltage trip (MX) coils and an auxiliary switch (OF) contact

SDTAM remote indication relay module with its terminal block.

Note: All the trip units have a transparent sealable cover that protects access to the adjustment rotary switches.

PowerPact™ H-, J-, and L-Frame Circuit Breakers Motor Circuit Protection

Table 50: Micrologic 2.2 M and 2.3 M Electronic Trip Unit

Rating: I_n at 104°F (40°C) ¹		30 A	50 A	100 A	150 A	250 A	400 A	600 A
Circuit Breaker	PowerPact H-frame	X	X	X	X	—	—	—
	PowerPact J-frame	—	—	—	—	X	—	—
	PowerPact L-frame	—	—	—	—	—	X	X

Overloads (or Thermal Protection): Long-Time Protection and Trip Class

Pick-Up (A) Tripping between 1.05 and 1.20 FLA	FLA		Value depending on trip unit rating (I_n) and setting on rotary switch								
	$I_n = 30$ A	FLA =	14	16	18	20	21	22	23	24	25
	$I_n = 50$ A	FLA =	14	17	21	24	27	29	32	36	42
	$I_n = 100$ A	FLA =	30	35	41	45	51	56	63	71	80
	$I_n = 150$ A	FLA =	58	71	78	86	91	97	110	119	130
	$I_n = 250$ A	FLA =	114	137	145	155	163	172	181	210	217
	$I_n = 400$ A	FLA =	190	210	230	250	270	290	310	330	348
	$I_n = 600$ A	FLA =	312	338	364	390	416	442	468	484	520

Time Delay

Trip Class		5	10	20		
Time Delay (s) Depending on selected trip class	t_r	1.5 x FLA	120	240	480	For warm start
		6 x FLA	6.5	13.5	26	For cold start
		7.2 x FLA	5	10	20	For cold start

S Short Circuits: Short-time protection with fixed time delay

Pick-up (A) accuracy $\pm 15\%$	$I_{sd} = FLA \times$	5	6	7	8	9	10	11	12	13
Time delay (ms)	t_{sd}	Non-adjustable								
	Non-tripping time	20								
	Maximum break time	60								

I Short Circuit: Non-adjustable instantaneous protection

Pick-up (A) accuracy $\pm 15\%$	I_i non-adjustable	450	750	1500	2250	3750	4800	7200
Time delay (ms)	Non-tripping time	0						
	Maximum break time	30 ms						

Phase unbalance or phase loss

Pick-up (A) accuracy $\pm 20\%$	I_{unbal} in % average current ²	30%
Time delay (ms)	Non-adjustable	0.7 s during starting 4 s during normal operation

¹ Motor standards require operation at 104°F (40°C). Circuit-breaker ratings are derated to take this requirement into account.

² The unbalance measurement takes into account the most unbalanced phase with respect to the average current.

PowerPact™ H-, J-, and L-Frame Circuit Breakers Motor Circuit Protection

Additional Technical Characteristics

Table 51: Additional Technical Characteristics

<p>Unbalance of Phase Currents and Voltages</p> <p>Motor Starting and Long Starts</p>	<p>Phase unbalance</p> <p>An unbalance in three-phase systems occurs when the three voltages are not equal in amplitude and/or not displaced 120° with respect to each other. It is generally due to single-phase loads that are incorrectly distributed throughout the system and unbalance the voltages between the phases.</p> <p>These unbalances create negative current components that cause braking torques and temperature rise in asynchronous machines, thus leading to premature ageing.</p> <p>Phase loss</p> <p>Phase loss is a special case of phase unbalance.</p> <ul style="list-style-type: none"> • During normal operation, it produces the effects mentioned above and tripping must occur after four seconds. • During starting, the absence of a phase may cause motor reversing, i.e. it is the load that determines the direction of rotation. This requires virtually immediate tripping (0.7 seconds). <p>Starting time in compliance with the class (Micrologic 2 M)</p> <p>For normal motor starting, Micrologic 2 M checks the conditions below with respect to the thermal-protection (long-time) pick-up FLA:</p> <ul style="list-style-type: none"> • current > 10% x FLA (motor-off limit) • overrun of 1.5 x FLA threshold, then return below this threshold before the end of a 10 s time delay. <p>If either of these conditions is not met, the thermal protection trips the device after a maximum time equal to that of the selected class. Pick-up FLA must have been set to the current indicated on the motor rating plate.</p> <p>Starting time in compliance with the class (Micrologic 2 M)</p> <p>For normal motor starting, Micrologic 2 M checks the conditions below with respect to the thermal-protection (long-time) pick-up FLA:</p> <ul style="list-style-type: none"> • current > 10% x FLA (motor-off limit) • overrun of 1.5 x FLA threshold, then return below this threshold before the end of a 10 s time delay <p>If either of these conditions is not met, the thermal protection trips the device after a maximum time equal to that of the selected class.</p> <p>Pick-up FLA must have been set to the current indicated on the motor rating plate.</p>
---	---

Table 52: L-Frame Electronic Trip Unit Magnetic Only 3 Pole, 600 Vac, 50/60 Hz—Three Device Solutions¹

Sensor Rating	Trip Unit	Adjustable ² Trip Range (A)	G-Interrupting Cat. No.	J-Interrupting Cat. No.	L-Interrupting Cat. No.	R-Interrupting Cat. No.
PowerPact L-Frame	400	500–1200%	LGL36400M37X	LJL36400M37X	LLL36400M37X	LRL36400M37X
	600	500–1200%	LGL36600M37X	LJL36600M37X	LLL36600M37X	LRL36600M37X

¹ Three-device solutions are the traditional solutions: motor circuit protector plus motor starter plus overload relay.

² UL magnetic trip tolerances are -20%/+30% from the nominal values shown.

PowerPact™ H-, J-, and L-Frame Circuit Breakers Motor Circuit Protection

Table 53: H-Frame (150 A), J-Frame (250 A) and L-Frame (600 A) Electronic Motor Protector Circuit Breakers (UL Ratings)—Two Device Solutions¹

Electronic Trip Unit Type	Frame	Sensor Rating	Trip Unit	Full Load Amperes Range (FLA)	I_{sd} (x FLA)	G Interrupting Cat. No.	J Interrupting Cat. No.	L Interrupting Cat. No.	R Interrupting Cat. No.
Standard ²	H-Frame	30	2.2 M	14–25	5-13 x FLA	HGL36030M38X	HJL36030M38X	HLL36030M38X	HRL36030M38X
		50		14–42	5-13 x FLA	HGL36050M38X	HJL36050M38X	HLL36050M38X	HRL36050M38X
		100		30–80	5-13 x FLA	HGL36100M38X	HJL36100M38X	HLL36100M38X	HRL36100M38X
		150		58–130	5-13 x FLA	HGL36150M38X	HJL36150M38X	HLL36150M38X	HRL36150M38X
	J-Frame	250	2.3 M	114–217	5-13 x FLA	JGL36250M38X	JJL36250M38X	JLL36250M38X	JRL36250M38X
	L-Frame	400		190–348	5-13 x FLA	LGL36400M38X	LJL36400M38X	LLL36400M38X	LRL36400M38X
		600		312–520	5-13 x FLA	LGL36600M38X	LJL36600M38X	LLL36600M38X	LRL36600M38X

¹ Two-device solutions (these electronic motor protector circuit breakers include short circuit and overload protection)

—1 electronic motor circuit protector with a Micrologic 2.2 M electronic trip unit, plus

—1 contactor

² The standard trip unit offers Class 5, 10 and 20 and phase unbalance or phase loss protection.

Section 6—Trip Units

Available Trip Units

- PowerPact™ H-, J-, and L-Frame circuit breakers offer a range of thermal-magnetic and Micrologic™ electronic trip units in interchangeable cases. Thermal-magnetic trip units are designed to open automatically under overload or short circuit. H-frame and J-frame thermal-magnetic circuit breakers contain individual thermal (overload) and instantaneous (short circuit) sensing elements in each pole.
- Micrologic electronic trip units provide intelligent operation, with wide setting ranges make installation upgrades easier. Designed with processing capabilities, Micrologic trip units can provide measurement information and device operating assistance to supply all of the information required to manage the electrical installation and optimize energy use.

Micrologic trip units offer excellent measurement accuracy, using a new generation of current transformers combining “iron-core” sensors for self-powered electronics and “air-core” sensors (Rogowski coils) for measurements. The protection functions are managed by an ASIC component that is independent of the measurement functions. This independence ensures immunity to conducted and radiated disturbances and a high level of reliability.

An LED on the front of the electronic trip units indicates the result of the self-test running continuously on the measurement system and the tripping release. When the green LED is flashing, the links between the CTs, the processing electronics and the Mitop release are operational. The circuit breaker is ready to protect. A minimum current of 15 to 50 A, depending on the device, is required for this function.



The dual adjustment for protection functions on Micrologic 5 / 6 consists of:

- an adjustment using rotary switches sets the maximum value
- an adjustment, made using the keypad or remotely, fine-tunes the setting. This setting may not exceed the first one. It can be read directly on the Micrologic screen, to within one ampere and a fraction of a second.

NOTE: All the trip units have a transparent sealable cover that protects access to the adjustment rotary switches.

PowerPact™ H-, J-, and L-Frame Circuit Breakers Trip Units

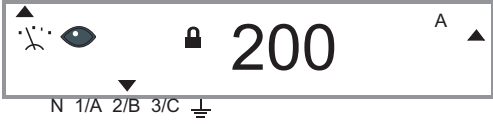
Table 54: Understanding the Names of Micrologic Electronic Trip Units

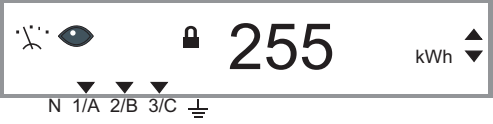
	Protection	Frame	Measurements	Applications
	1: I 3: LI or LSI 5: LSI 6: LSIG	H- and J-frame 	A: Ammeter Ir tr lsd tsd li lg tg 	Distribution or M: Motors
	L: Long time S: Short time I: Instantaneous G: Ground fault	L-frame 	E: Energy Ir tr lsd tsd li (x In) 	









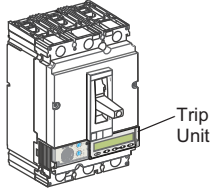
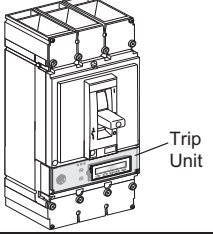
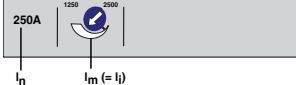
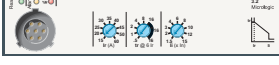
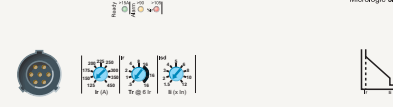

Examples

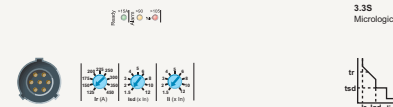
Micrologic 1.3 M Trip Unit	Instantaneous only	400 or 600 A	Motor
Micrologic 3.3 Trip Unit	LI	250, 400, or 600 A	Distribution
Micrologic 3.2S Trip Unit	LSI	60, 100, 150, or 250 A	Distribution
Micrologic 5.2A Trip Unit	LSI—Ammeter	60, 100, 150, or 250 A	Distribution

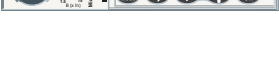
For Micrologic trip unit features, see table 9 on page 20.

PowerPact™ H-, J-, and L-Frame Circuit Breakers Trip Units

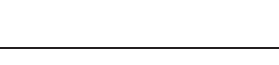
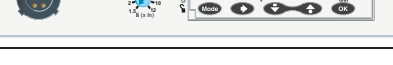
Table 55: Trip Unit Availability

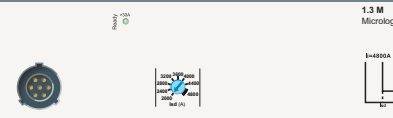
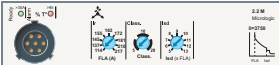
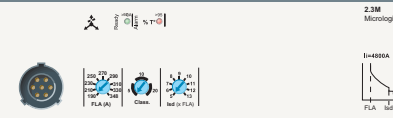
Trip Unit Type	Trip Unit	H-, J-Frame 	Trip Unit	L-Frame 
Distribution Protection Thermal-Magnetic	T-M		N/A	
Distribution Protection LI	Micrologic 3.2 and 3.2-W		Micrologic 3.3 and 3.3-W	
Distribution Protection LSI Fixed ST and LT delays	Micrologic 3.2S and 3.2S-W		Micrologic 3.3S and 3.3S-W	
Distribution Protection LSI + Ammeter	Micrologic 5.2 A and 5.2 A-W		Micrologic 5.3 A and 5.3 A-W	
Distribution Protection LSI + Energy Monitoring	Micrologic 5.2 E and 5.2 E-W		Micrologic 5.3 E and 5.3 E-W	
Distribution Protection LSIG + Ammeter	Micrologic 6.2 A and 6.2 A-W		Micrologic 6.3 A and 6.3 A-W	
Distribution Protection LSIG + Energy Monitoring	Micrologic 6.2 E and 6.2 E-W		Micrologic 6.3 E and 6.3 E-W	
Motor Circuit Protection Magnetic Only	M		N/A	
Motor Protection Micrologic 1 M	N/A		Micrologic 1.3M	
Motor Protection Micrologic 2 M	Micrologic 2.2 M		Micrologic 2.3 M	

NOTE: W = mission critical trip unit.

Protection of Distribution Systems

Thermal-Magnetic Trip Units

TM thermal-magnetic trip units can be used on PowerPact H and J-frame circuit breakers with interrupting levels D/G/J/L. Thermal-magnetic trip units are available in factory sealed or field-interchangeable constructions.

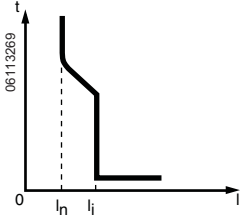

H-Frame Trip Curve

- (I_n) Fixed threshold thermal protection against overload
- (I_i) Fixed threshold instantaneous protection against short circuits

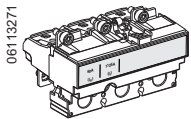

H-Frame Trip Unit

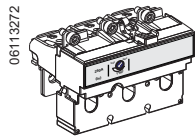

J-Frame Trip Unit

Table 56: H-Frame and J-Frame 3P Field-Installable Thermal-Magnetic Trip Unit

15–60 A H-Frame		70–150 A H-Frame		150–250 A J-Frame	
Amperage	Cat. No.	Amperage	Cat. No.	Amperage	Cat. No.
15 A	HT3015	70 A	HT3070	150 A	JT3150
20 A	HT3020	80 A	HT3080	175 A	JT3175
25 A	HT3025	90 A	HT3090	200 A	JT3200
30 A	HT3030	100 A	HT3100	225 A	JT3225
35 A	HT3035	110 A	HT3110	250 A	JT3250
40 A	HT3040	125 A	HT3125	—	—
45 A	HT3045	150 A	HT3150	—	—
50 A	HT3050	—	—	—	—
60 A	HT3060	—	—	—	—

PowerPact™ H-, J-, and L-Frame Circuit Breakers Trip Units

Micrologic 3 Trip Units

Micrologic 3 trip units can be used on PowerPact H-, J-, and L-Frame circuit breakers with performance levels D/G/J/L.

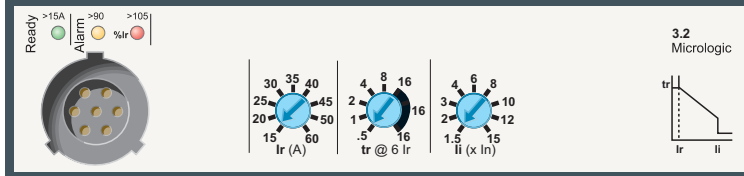

They provide:

- standard protection of distribution cables
- indication of:
 - overloads (using LEDs)
 - overload tripping (using the SDx relay module).

Circuit breakers equipped with Micrologic 3 trip units can be used to protect distribution systems supplied by transformers.

Protection

Settings are made using the adjustment rotary switches.

Overloads: Long time protection (I_r)

Inverse time protection against overloads with an adjustable current pick-up I_r set using a rotary switch and an adjustable time delay t_r .

Neutral protection

- On 3-pole L-frame circuit breakers, neutral protection is not possible.
- On four-pole L-frame circuit breakers, neutral protection may be set using a three-position switch:
 - switch position 4P 3D: neutral unprotected
 - switch position 4P 3D + N/2: neutral protection at half the value of the phase pick-up, ($0.5 \times I_r$)
 - switch position 4P 4D: neutral fully protected at I_r

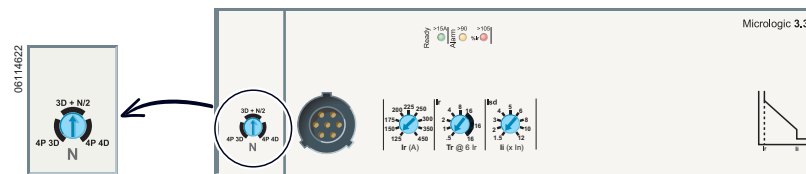

Indicators

Front indicators

- The green “Ready” LED blinks slowly when the electronic trip unit is ready to provide protection. It indicates the trip unit is operating correctly.
- Orange overload pre-alarm LED: steady on when $I > 90\% I_r$
- Red overload LED: steady on when $I > 105\% I_r$

Remote indicators

An overload trip signal can be remotely checked by installing an SDx relay module inside the circuit breaker. This module receives the signal from the Micrologic electronic trip unit through an optical link and makes it available on the terminal block. The signal is cleared when the circuit breaker is reclosed. See page 98.

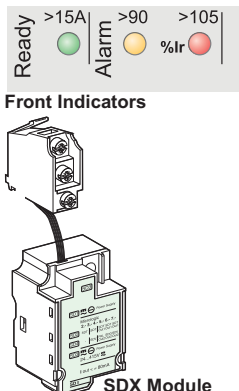

PowerPact™ H-, J-, and L-Frame Circuit Breakers Trip Units

Table 57: Micrologic 3 Trip Unit

Ratings	I_n at 104°F (40°C) ¹		60 A	100 A	150 A	250 A	400 A	600 A
Circuit Breaker	H-frame		X	X	X			
	J-frame					X		
	L-frame					X	X	X

Micrologic 3.2 / 3.3 trip units²

L Long-time protection

Pick-Up (A) Tripping between 1.05 and 1.20 I_r	I_r		Value depending on sensor rating (I_n) and setting on rotary switch								
	$I_n = 60$ A	$I_r =$	15	20	25	30	35	40	45	50	60
	$I_n = 100$ A	$I_r =$	35	40	45	50	60	70	80	90	100
	$I_n = 150$ A	$I_r =$	50	60	70	80	90	100	110	125	150
	$I_n = 250$ A	$I_r =$	70	80	100	125	150	175	200	225	250
	$I_n = 400$ A	$I_r =$	125	150	175	200	225	250	300	350	400
	$I_n = 600$ A	$I_r =$	200	225	250	300	350	400	450	500	600
Time Delay (s) Accuracy 0 to -20%	t_r		0.5	1	2	4	8	16			
		$1.5 \times I_r$	15	25	50	100	200	400			
		$6 \times I_r$	0.5	1	2	4	8	16			
		$7.2 \times I_r$	0.35	0.7	1.4	2.8	5.5	11			
Thermal memory			20 minutes before and after tripping								

I Instantaneous

Pick-up (A) accuracy $\pm 15\%$	$I_i \times$	60 A	1.5	2	3	4	6	8	10	12	15
		100 A	1.5	2	3	4	6	8	10	12	15
		150 A	1.5	2	3	4	6	8	10	12	15
		250 A	1.5	2	3	4	5	6	8	10	12
		400 A	1.5	2	3	4	5	6	8	10	12
		600 A	1.5	2	3	4	5	6	8	10	11
Non-tripping time		10 ms									
Maximum break time		50 ms for $I > 1.5 I_i$									

Micrologic 3.2S / 3.3S trip units²

L Long-time protection

Pick-Up (A) Tripping between 1.05 and 1.20 I_r	I_r		Value depending on sensor rating (I_n) and setting on rotary switch								
	$I_n = 60$ A	$I_r =$	15	20	25	30	35	40	45	50	60
	$I_n = 100$ A	$I_r =$	35	40	45	50	60	70	80	90	100
	$I_n = 150$ A	$I_r =$	50	60	70	80	90	100	110	125	150
	$I_n = 250$ A	$I_r =$	70	80	100	125	150	175	200	225	250
	$I_n = 400$ A	$I_r =$	125	150	175	200	225	250	300	350	400
	$I_n = 600$ A	$I_r =$	200	225	250	300	350	400	450	500	600
Time Delay (s) Accuracy 0 to -20%	t_r		non-adjustable								
		$1.5 \times I_r$	400								
		$6 \times I_r$	16								
		$7.2 \times I_r$	11								
Thermal memory			20 minutes before and after tripping								

S Short-time protection

Pick-up (A) accuracy $\pm 10\%$	$I_{sd} - I_r \times \dots$		1.5	2	3	4	5	6	7	8	10
Time delay (ms)	t_{sd}		non-adjustable								
	Non-tripping time		20								
Maximum break time		80									

I Instantaneous

Pick-up (A) accuracy $\pm 15\%$	$I_i \times I_n$	1.5	2	3	4	6	8	10	12	15	
	Non-tripping time		10 ms								
Maximum break time		50 ms for $I > 1.5 I_i$									

¹ If the trip units are used in high-temperature environments, the Micrologic trip unit setting must take into account the thermal limitations of the circuit breaker. See the temperature derating information on page 130.

² Mission Critical trip units have a "-W" at the end of the number (for example 3.2-W). All other protections are the same and have the same trip curves.

PowerPact™ H-, J-, and L-Frame Circuit Breakers Trip Units

Micrologic 5 / 6 A or E Trip Units

Micrologic 5 / 6 A (Ammeter) or E (Energy) trip units can be used on PowerPact H-, J-, and L-frame circuit breakers with performance levels D, G, J, or L. They all have a front display module. They offer basic LSI protection (Micrologic 5 trip unit) or LSI and ground-fault protection G (Micrologic 6 trip unit). They also offer measurement, alarm and energy values.

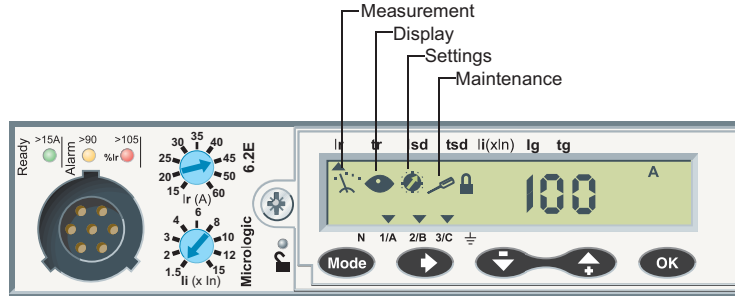

The capabilities of Micrologic 5 / 6 A and E trip units come into full play with the front display module. When the two are connected using a simple cable with RJ45 connectors, the combination offers full Power Meter capabilities and all the measurements required to monitor the electrical installation.

	Measurements	Operating and Maintenance Assistance	Communication Network
Ammeter (Micrologic A Trip Unit)	<p>Current measurements</p> <ul style="list-style-type: none"> Phase and neutral currents I_A, I_B, I_C, I_N Average current of the 3 phases I_{avg} Highest current of the three phases I_{max} Ground-fault current I_g (Micrologic 6.2 / 6.3 A) trip units Maximum and minimum current measured 	<p>Indicators, alarms and histories</p> <ul style="list-style-type: none"> Fault types Alarms for high/low alarm thresholds linked to I measurements Trip, alarm and operating histories Time-stamped tables for settings and maximum current <p>Maintenance indicators</p> <ul style="list-style-type: none"> Operation, trip and alarm counters Operating hours counter Contact wear Load profile and thermal image 	Modbus with add-on module
Energy (Micrologic E Trip Unit)	<p>Current measurements</p> <ul style="list-style-type: none"> Phase and neutral currents I_A, I_B, I_C, I_N Average current of the 3 phases I_{avg} Highest current of the three phases I_{max} Ground-fault current I_g (Micrologic 6.2 / 6.3 A trip units) Maximum and minimum current measured Current unbalance between phases <p>Voltage measurements</p> <ul style="list-style-type: none"> Phase-to-phase (V) and phase-to-neutral (U) voltages Average voltages V_{avg}, U_{avg} Ph-Ph (V) and Ph-N (U) voltage unbalance <p>Frequency measurements</p> <ul style="list-style-type: none"> Frequency (f) <p>Power-quality indicators</p> <ul style="list-style-type: none"> Total harmonic distortion (THD) for current and voltage <p>Power measurements</p> <ul style="list-style-type: none"> Active, reactive and apparent power, total and per phase Power factor and $\cos \phi$ <p>Maximum and minimum</p> <ul style="list-style-type: none"> For all I, V, f, P, E measurements <p>Demand current and power measurements</p> <ul style="list-style-type: none"> Demand values, total and per phase Maximum demand <p>Energy metering</p> <ul style="list-style-type: none"> Active, reactive and apparent energy, total and per phase 	<p>Indicators, alarms and histories</p> <ul style="list-style-type: none"> Fault types Alarms for high/low thresholds linked to I, V, f, P, E measurements Trip, alarm and operating histories Time-stamped tables for settings and I, V, f, P, E maximum values <p>Maintenance indicators</p> <ul style="list-style-type: none"> Operation, trip and alarm counters Operating hours counter Contact wear Load profile and thermal image 	Modbus with add-on module

Power Requirements

The amount of current needed to power the trip unit is printed in the upper left hand corner of the trip unit by the Ready LED.

Table 58: Trip Unit Power Requirements

Frame		Power-Up Requirement
H-Frame, 60 A	60 A	> 15 A
	100 A	> 15 A
	150 A	> 30 A
J-Frame, 250A	250A	> 30 A
L-Frame, 600 A	400 A	> 50 A
	600 A	> 50 A

Protection

Settings can be adjusted in two ways, using the rotary switches and/or the keypad.

- The keypad can be used to make fine adjustments in 1 A steps below the maximum value defined by the setting on the rotary switch.
- Access to setting modifications using the keypad is protected by a locking function displayed on the screen and controlled by a microswitch.
- The lock is activated automatically if the keypad is not used for 5 minutes.
- Access to the microswitch is protected by a transparent, sealable cover.
- With the cover closed, it is still possible to display the various settings and measurements using the keypad.

Overloads: Long-Time Protection (I_r)

Inverse time protection against overloads with an adjustable current pick-up I_r is set using a rotary switch or the keypad for fine adjustments. The time delay t_r is set using the keypad.

Short-Circuits: Short-Time Protection (I_{sd})

Short-circuit protection with an adjustable pick-up I_{sd} and adjustable time delay t_{sd} , with the possibility of including a portion of an inverse time curve (I^2t On).

Short-Circuits: Instantaneous Protection (I_i)

Instantaneous protection with adjustable pick-up I_i .

Additional Ground Fault Protection (I_g) on Micrologic 6 Trip Units

Residual type ground-fault protection with an adjustable pick-up I_g and adjustable time delay t_g . Possibility of including a portion of an inverse time curve (I^2t On).

Neutral Protection

- On 4-pole circuit breakers, this protection can be set using the keypad:
 - Off: neutral unprotected
 - 0.5: neutral protection at half the value of the phase pick-up ($0.5 \times I_r$)
 - 1.0: neutral fully protected at I_r
 - OSN: Oversized neutral protection at 1.6 times the value of the phase pick-up.
Used when there is a high level of 3rd order harmonics (or orders that are multiples of 3) that accumulate in the neutral and create a high current. In this case, the device must be limited to $I_r = 0.63 \times I_n$ for the maximum neutral protection setting of $1.6 \times I_r$.
- With 3-pole circuit breakers, the neutral can be protected by installing an external neutral sensor with the output (T1, T2) connected to the trip unit.

PowerPact™ H-, J-, and L-Frame Circuit Breakers Trip Units

Zone Selective Interlocking (ZSI)

A ZSI terminal block may be used to interconnect a number of Micrologic trip units to provide zone selective interlocking for short-time (I_{sd}) and ground-fault (I_g) protection, without a time delay. For PowerPact H- and J-frame circuit breakers, the ZSI function is available only in relation to the upstream circuit breaker (ZSI out). For PowerPact L-frame circuit breakers, the ZSI function is available in relation to the upstream circuit breaker (ZSI out) and downstream circuit breakers (ZSI in).

Display of Type of Fault.

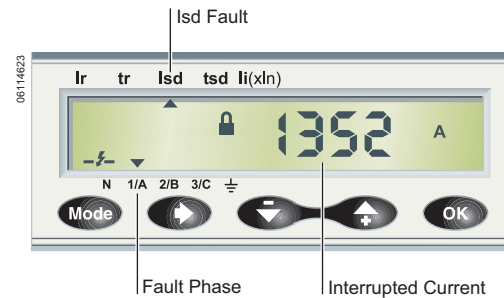

On a fault trip, the type of fault (I_r , I_{sd} , I_j , I_g), the phase concerned and the interrupted current are displayed. An external power supply is required.

Display of Interrupted Current.

Indicators

Front Indicators

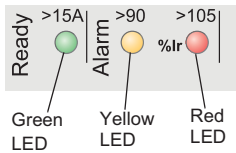

- The green “Ready” LED blinks slowly when the electronic trip unit is ready to provide protection. It indicates the trip unit is operating correctly.
- Orange overload pre-alarm LED stays on when $I > 90\% I_r$
- Red overload LED stays on when $I > 105\% I_r$

Remote Indicators

An SDx relay module installed inside the circuit breaker can be used to remote the following information:

- overload trip
- overload prealarm (Micrologic 5 trip units) or ground fault trip (Micrologic 6 trip units).

This module receives the signal from the Micrologic electronic trip unit through an optical link and makes it available on the terminal block. The signal is cleared when the circuit breaker is closed.

Note: all the trip units have a transparent sealable cover.

These outputs can be reprogrammed to be assigned to other types of tripping or that protects access to the adjustment rotary switch. The module is described in detail in the section dealing with accessories.

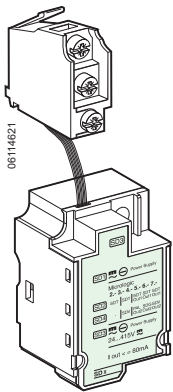

SDx Module

PowerPact™ H-, J-, and L-Frame Circuit Breakers Trip Units

Table 59: Micrologic 5/6 Trip Unit¹

Ratings	I_n at 104°F (40°C) ²	60 A	100 A	150 A	250 A	400 A	600 A
Circuit Breaker	H-frame	X	X	X			
	J-frame				X		
	L-frame					X	X

L Long-time protection

Pick-up (A) tripping between 1.05 and 1.20 I_r	I_r	rotary switch	Value depending on the trip unit rating (I_n) and setting on rotary switch								
	$I_n = 60$ A	$I_r =$	15	20	25	30	35	40	45	50	60
	$I_n = 100$ A	$I_r =$	35	40	45	50	60	70	80	90	100
	$I_n = 150$ A	$I_r =$	50	60	70	80	90	100	110	125	150
	$I_n = 250$ A	$I_r =$	70	80	100	125	150	175	200	225	250
	$I_n = 400$ A	$I_r =$	125	150	175	200	225	250	300	350	400
Time Delay (s) Accuracy 0 to -20%		keypad setting	Fine adjustment in 1 A steps below maximum value set on rotary switch								
	$t_r =$	keypad setting	0.5	1	2	4	8	16			
		1.5 x I_r	15	25	50	100	200	400			
		6 x I_r	0.5	1	2	4	8	16			
		7.2 x I_r	0.35	0.7	1.4	2.8	5.5	11			
Thermal memory			20 minutes before and after tripping								

S Short-time protection

Pick-up (A) accuracy ± 10%	I_{sd}	keypad setting	1.5	2	2.5	3	3.5	4	4.5	5	5.5	6	6.5	7	7.5	8	8.5	9	9.5	10
			Fine adjustment in 0.5 x I_r steps using the keypad																	
Time delay	$t_{sd} =$	Keypad setting	I^2t Off	0	0.1 s	0.2 s	0.3 s	0.4 s												
			I^2t On	—	0.1 s	0.2 s	0.3 s	0.4 s												
		Non-tripping time		20 ms	80 ms	140 ms	230 ms	350 ms												
	Maximum break time		80 ms	140 ms	200 ms	320 ms	500 ms													

I Instantaneous

Pick-up (A) accuracy ± 15%	$I_i = I_n \times$	Rotary Switch	60 A	1.5	2	.3	4	6	8	10	12	15
			100 A	1.5	2	.3	4	6	8	10	12	15
			150 A	1.5	2	.3	4	6	8	10	12	15
			250 A	1.5	2	.3	4	5	6	8	10	12
			400 A	1.5	2	.3	4	5	6	8	10	12
			600 A	1.5	2	.3	4	5	6	8	10	11
		Non-tripping time	10 ms									
		Maximum break time	50 ms for $I > I_i$									

G Ground-fault protection - for Micrologic 6 A or E Trip Units

Pick-up (A) accuracy ± 10%	I_g	Keypad Setting	$I_n = 60$ A	$I_g =$	0.3	0.35	0.4	0.45	0.5	0.55	0.6	0.65	0.7	0.75	0.8	0.85	0.9	0.95	1		
			$I_n = 100-600$ A	$I_g =$	0.2	2.5	0.3	0.35	0.4	0.45	0.5	0.55	0.6	0.65	0.7	0.75	0.8	0.85	0.9	0.95	1
Time delay (s)	$t_g =$	Keypad setting	I^2t Off	0	0.1	0.2	0.3	0.4													
			I^2t On	—	0.1	0.2	0.3	0.4													
		Non-tripping time		20	80	140	230	350													
		Maximum break time		80	140	200	320	500													
Test	I_g function		Built in																		

¹ Mission Critical trip units have a “-W” at the end of the number (for example 3.2-W). All other protections are the same and have the same trip curves.

² If the trip units are used in high-temperature environments, the Micrologic trip unit setting must take into account the thermal limitations of the circuit breaker. See the temperature derating information on page 130.

PowerPact™ H-, J-, and L-Frame Circuit Breakers Trip Units

Table 60: Micrologic 3 Field-Installable Trip Units¹

Circuit Breaker				Trip Unit Type	Catalog No.
Frame	Standard	Poles	Rating		
H-frame	UL/CSA/NOM	3P	60 A	Micrologic 3.2	HE3060U31X
		3P	60 A	Micrologic 3.2S	HE3060U33X
		3P	100 A	Micrologic 3.2	HE3100U31X
		3P	100 A	Micrologic 3.2S	HE3100U33X
		3P	150 A	Micrologic 3.2	HE3150U31X
		3P	150 A	Micrologic 3.2S	HE3150U33X
J-Frame	UL/CSA/NOM	3P	250 A	Micrologic 3.2	JE3250U31X
		3P	250 A	Micrologic 3.2S	JE3250U33X
L-Frame	UL/CSA/NOM	3P	250 A	Micrologic 3.3	LE3250U31X
				Micrologic 3.3S	LE3250U33X
			400 A	Micrologic 3.3	LE3400U31X
				Micrologic 3.3S	LE3400U33X
			600 A	Micrologic 3.3	LE3600U31X
				Micrologic 3.3S	LE3600U33X
		4P	250 A	Micrologic 3.3	LE4250U31X
				Micrologic 3.3S	LE4250U33X
			400 A	Micrologic 3.3	LE4400U31X
				Micrologic 3.3S	LE4400U33X
			600 A	Micrologic 3.3	LE4600U31X
				Micrologic 3.3S	LE4600U33X

¹ Mission Critical trip units that end in "W" are factory sealed and are not available as field installable units.

PowerPact™ H-, J-, and L-Frame Circuit Breakers Trip Units

Table 61: Micrologic 5 and 6 Field-Installable Trip Units¹

Circuit Breaker				Trip Unit Type	Catalog No.
Frame	Standard	Poles	Rating		
H-frame	UL/CSA/NOM	3P	60 A	Micrologic 5.2 A	HE3060U43X
				Micrologic 6.2 A	HE3060U44X
				Micrologic 5.2 E	HE3060U53X
				Micrologic 6.2 E	HE3060U54X
			100 A	Micrologic 5.2 A	HE3060U43X
				Micrologic 6.2 A	HE3100U44X
				Micrologic 5.2 E	HE3100U53X
				Micrologic 6.2 E	HE3100U54X
			150 A	Micrologic 5.2 A	HE3150U43X
				Micrologic 6.2 A	HE3150U44X
				Micrologic 5.2 E	HE3150U53X
				Micrologic 6.2 E	HE3150U54X
J-Frame	UL/CSA/NOM	3P	250 A	Micrologic 5.2 A	JE3250U43X
				Micrologic 6.2 A	JE3250U44X
				Micrologic 5.2 E	JE3250U53X
				Micrologic 6.2 E	JE3250U54X
L-Frame	UL/CSA/NOM	3P	400 A	Micrologic 5.3 A	LE3400U43X
				Micrologic 6.3 A	LE3400U44X
				Micrologic 5.3 E	LE3400U53X
				Micrologic 6.3 E	LE3400U54X
			600 A	Micrologic 5.3 A	LE3600U43X
				Micrologic 6.3 A	LE3600U44X
				Micrologic 5.3 E	LE3600U53X
				Micrologic 6.3 E	LE3600U54X
	UL/CSA/NOM	4P	400 A	Micrologic 5.3 A	LE4400U43X
				Micrologic 6.3 A	LE4400U44X
				Micrologic 5.3 E	LE4400U53X
				Micrologic 6.3 E	LE4400U54X
600 A	Micrologic 5.3 A	LE4600U43X			
	Micrologic 6.3 A	LE4600U44X			
	Micrologic 5.3 E	LE4600U53X			
	Micrologic 6.3 E	LE4600U54X			

¹ Mission Critical trip units that end in "W" are factory sealed and are not available as field installable units.

Table 62: Micrologic Spare Parts

Description	Frame	Trip Unit	Catalog No.
LCD Display	H/J/L	Micrologic 5	S429483
		Micrologic 6	S429484
Trip Unit Cover-Transparent	H/J	Micrologic 3	S429481
	L		S432461
	H/J	Micrologic 5/6	S429478
	L		S432459
Trip Unit Wire Seal	H	Micrologic 3/5/6	MICROTUSEAL

PowerPact™ H-, J-, and L-Frame Circuit Breakers Trip Units

Power Meter Functions

In addition to protection functions, Micrologic 5 / 6 trip units offer all the functions of Power Meter products as well as operating-assistance for the circuit breaker.

- display of settings
- measurement functions:
 - Ammeter (A)
 - Energy (E)
- alarms
- time-stamped histories and event tables
- maintenance indicator
- communication network.

Micrologic A and E trip unit measurement functions are made possible by the trip unit intelligence and the accuracy of the sensors. They are handled by a microprocessor that operates independent of protection functions.

Display

Micrologic Trip Unit LCD

The user can display all the protection settings and the main measurements on the LCD screen of the trip unit.

- Micrologic A trip unit: instantaneous rms current measurements
- Micrologic E trip unit: voltage, frequency and power measurements and energy metering, in addition to the measurements offered by Micrologic A

To make the display available under all conditions and increase operating comfort, an external power supply is recommended for Micrologic A trip unit. It is indispensable to:

- display faults and interrupted current measurements
- use all the functions of Micrologic E trip unit (such as metering of low power and energy values)
- ensure operation of the communication network.

The external power supply can be shared by several devices. For description, see page 83.

Front Display Module (FDM121)

An FDM121 can be connected to a Micrologic trip unit using a prefabricated cable to display all measurements on a screen. The result is a veritable 96 x 96 mm Power Meter.

In addition to the information displayed on the Micrologic trip unit LCD, the FDM121 screen shows demand, power quality and maximum/minimum values along with alarms, histories and maintenance indicators.

The FDM121 requires a 24 Vdc power supply. The Micrologic trip unit is supplied by the same power supply through the cable connecting it to the FDM.

PC Screen

When the Micrologic trip unit, with or without a front display module, is connected to a communication network, all information can be accessed using a PC with the appropriate software installed.

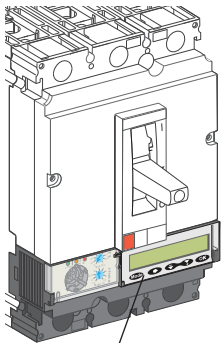

Trip Unit LCD

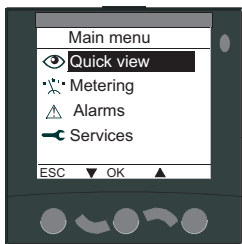

FDM121 Display

Measurements

Instantaneous RMS Measurements

The Micrologic A and E trip units continuously display the RMS value of the highest current of the three phases and neutral (Imax). The navigation buttons can be used to scroll through the main measurements.

In the event of a fault trip, the current interrupted is memorized.

The Micrologic A trip unit measures phase, neutral, ground fault currents. The Micrologic E trip unit offers voltage, frequency and power measurements in addition to the measurements provided by Micrologic A trip unit.

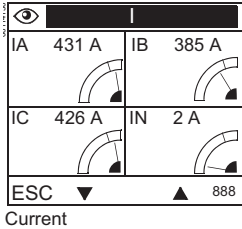

Maximum / Minimum Values

Every instantaneous measurement provided by Micrologic A or E trip unit can be associated with a maximum/minimum. The maximum for the highest current of the three phases and neutral, the demand current and power can be reset using the trip unit keypad, the front display module or the communication network.

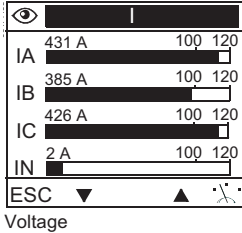

Energy Metering

The Micrologic E trip units also measures the energy consumed since the last reset of the meter. The active energy meter can be reset using the keypad and the front display module or the communication network.

Demand and Maximum Demand Values

Micrologic E trip units also calculates demand current and power values. These calculations can be made using a block or sliding interval that can be set from 5 to 60 minutes in steps of 1 minute. The window can be synchronized with a signal sent through the communication network. Whatever the calculation method, the calculated values can be recovered on a PC using the Modbus™ communication network.

Ordinary spreadsheet software can be used to provide trend curves and forecasts based on this data. They will provide a basis for load shedding and reconnection operations used to adjust consumption to the subscribed power.

Power Quality

Micrologic E trip units calculate power quality indicators taking into account the presence of up to the 15th order, including the total harmonic distortion (THD) of unit. current and voltage.

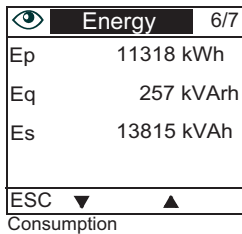
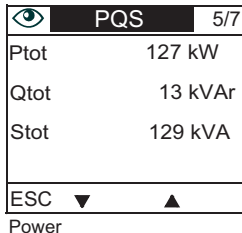

NOTE: The front display module will display voltage and current phases as A/B/C instead of 1/2/3.

PowerPact™ H-, J-, and L-Frame Circuit Breakers Trip Units

Table 63: Micrologic 5/6 Trip Units Integrated Power Meter Functions

			Type		Display			
			A	E	Trip Unit LCD	Front Display Module		
Display of Protection Settings								
Pick-ups (A) and delays	All settings can be displayed	$I_r, t_r, I_{sd}, t_{sd}, I_p, I_g, t_g$	X	X	X			
Measurements								
Instantaneous rms measurements								
Currents (A)	Phase and neutral	I_A, I_B, I_C, I_N	X	X	X		X	
	Average of phases	$I_{avg} = (I_A + I_B + I_C) / 3$	X	X	—		X	
	Highest current of the 3 phases and neutral	I_{max} of I_A, I_B, I_C, I_N	X	X	X		X	
	Ground fault (Micrologic 6 trip unit)	% I_g (pick-up setting)	X	X	X		X	
	Current unbalance between phases	% I_{avg}	—	X	—		X	
Voltage (V)	Phase-to-phase	V_{AB}, V_{BC}, V_{CA}	—	X	X		X	
	Phase-to-neutral	U_{AN}, U_{BN}, U_{CN}	—	X	X		X	
	Average of phase-to-phase voltages	$V_{avg} = (V_{AB} + V_{AC} + V_{BC}) / 3$	—	X	—		X	
	Average of phase-to-neutral voltages	$U_{avg} = (U_{AN} + U_{BN} + U_{CN}) / 3$	—	X	—		X	
	Ph-Ph and Ph-N voltage unbalance	% V_{avg} and % U_{avg}	—	X	—		X	
	Phase sequence	1-2-3, 1-3-2	—	X	X		X	
Frequency (Hz)	Power System	f	—	X	X		X	
Power	Active (kW)	P, total/per phase	—	X	X		X	
	Reactive (kVAR)	Q, total/per phase	—	X	X		X	
	Apparent (kVA)	S, total/per phase	—	X	X		X	
	Power factor and $\cos \phi$ (fundamental)	PF and $\cos \phi$, total and per phase	—	X	—		X	
Maximum, minimum (MAX/MIN)								
	Associated with instantaneous rms measurements	Reset with Micrologic trip unit or front display module	X	X	—		X	
Energy metering								
Energy	Active (kWh), reactive (kVAR), apparent (kVA)	Total since last reset Absolute or signed mode ¹	—	X	X		X	
Demand and maximum demand values								
Demand current (A)	Phases and neutral	Present value on the selected window	—	X	—		X	
		Maximum demand since last reset	—	X	—		X	
Demand power	Active (kWh), reactive (kVAR), apparent (kVA)	Present value on the selected window	—	X	—		X	
		Maximum demand since last reset	—	X	—		X	
Calculation window		Adjustable from 5 to 60 minutes in 1 minute steps	—	X	—		2	
Power quality								
Total harmonic distortion THD (%)	Of voltage with respect to rms value	THDU, THDV of the Ph-Ph and Ph-N voltage	—	X	—		X	
	Of current with respect to rms value	THDI of the phase current	—	X	—		X	

¹ Absolute mode: E absolute = E out + E in; Signed mode: E signed = E out - E in.

² Available through the communication network only.

Additional technical characteristics

Measurement accuracy of the entire measurement system, including the sensors:

- Current: +/- 1%
- Voltage: +/- 0.5%
- Power and energy: +/- 2%
- Frequency: +/- 0.1%.

Operating-Assistance Functions Characteristics

Micrologic Trip Unit Alarms with Time-Stamping

Alarm Types

The user can assign an alarm to all Micrologic A or E trip unit measurements or events:

- up to 12 alarms can be used together:
 - two alarms are predefined and activated automatically:
Micrologic 5 trip unit: overload (I_r)
Micrologic 6 trip unit: overload (I_r) and ground fault (I_g)
 - thresholds, priorities and time delays can be set for ten other alarms.
- the same measurement can be used for different alarms to precisely monitor certain values, e.g. the frequency or the voltage
- alarms can also be assigned to various states: phase lead/lag, four quadrants,
- phase sequence selection of display priorities, with screen displaying a window showing high priority alarm
- alarm time-stamping.

Alarm Settings

Alarms cannot be set using the keypad or the front display module. They are set through the communication network with the PC. Set-up includes the threshold, priority, activation delay before display and deactivation delay. It is also possible to reprogram the standard assignment for the two SDx relay outputs to user-selected alarms.

Alarm Reading

Remote alarm indicators

- reading on the front display module or on a PC through the communication network
- system remote indicators using SDx relay with two output contacts for alarms.
- Micrologic trip unit built-in LCD display.

Histories and Event Tables

Micrologic A and E trip unit have histories and event tables that are always active.

Three types of time-stamped histories

- Tripping due to overruns of I_r , I_{sd} , I_i , I_g : last 17 trips
- Alarms: last 10 alarms
- Operating events: last 10 events

Each history record is stored with:

- indicators in clear text in a number of user-selectable languages
- time-stamping: date and time of event
- status: pick-up / drop-out

PowerPact™ H-, J-, and L-Frame Circuit Breakers Trip Units

Two types of time-stamped event tables

- Protection settings
- Minimums / maximums

Display of alarms and tables

The time-stamped history and event tables may be displayed on a PC through the communication network.

Embedded memory

Micrologic A and E trip units have a non-volatile memory that saves all data on alarms, histories, event tables, counters and maintenance indicators even if power is lost.

Maintenance Indicators

Micrologic A and E trip units have indicators for, among others, the number of operating cycles, contact wear and operating times (operating hours counter) of the PowerPact H-, J-, and L-frame circuit breakers.

It is possible to assign an alarm to the operating cycle counter to plan maintenance. The various indicators can be used together with the trip histories to analyze the level of stresses the device has been subjected to. The information provided by the indicators cannot be displayed on the Micrologic trip unit LCD. It is displayed on the PC through the communication network.

Management of Installed Devices

Each circuit breaker equipped with a Micrologic 5 or 6 trip unit can be identified using the communication network:

- serial number
- firmware version
- hardware version
- device name assigned by the user.

This information together with that previously described provides a clear view of the state of the installed devices.

NOTE: Please refer to page 77 for more details on display formats.

PowerPact™ H-, J-, and L-Frame Circuit Breakers Trip Units

Table 64: Micrologic 5/6 Trip Units Operating Assistance Functions

		Type		Display								
		A	E	Trip Unit LCD	Front Display Module							
Operating Assistance												
Personalized Alarms												
Settings	Up to 10 alarms assigned to all A and E measurements Phase lead/lag, four quadrants, phase sequence, display priority selection	X	X	—		1						
Display	Alarms and tripping	X	X	—		1						
Remote Indicators	Activation of two dedicated contacts on SDx module	X	X	—		1						
Time-Stamped Histories												
Trips (last 17)	Cause of tripping (time-stamping with ms)	I_r , I_{sd} , I_i (Micrologic 5, 6 Trip Unit)	X	X	—	1						
		I_g (Micrologic 6 Trip Unit)	X	X	—	1						
Alarms (last 10)			X	X	—	1						
Operating events (last 10)	Event types	Modification of protection setting by rotary switch	—	X	—	1						
		Opening of keypad lock	—	X	—	1						
		Test using keypad	—	X	—	1						
		Test using external tool	—	X	—	1						
		Time setting (date and time)	—	X	—	1						
		Reset for maximum, minimum and energy meter	X	X	X	X	X					
Time Stamping	Presentation		X	X	—	1						
Time-Stamped Event Tables												
Protection settings	Setting modified (value displayed)	I_r	t_r	I_{sd}	t_{sd}	I_i	I_g	t_g	X	X	—	1
	Time-stamping	Date and time of modification							X	X	—	1
	Previous value	Value before modification							X	X	—	1
Min/Max	Values monitored	I_A	I_B	I_C	I_N	I_i			X	X	—	1
	Time-stamping	Date and time of min/max record							X	X	—	1
	Previous value	Min/max value							X	X	—	1
Maintenance Indicators												
Counter	Mechanical cycles ²	Assignable to an alarm										
	Electrical cycles ²	Assignable to an alarm										
	Trips	One per type of trip					X	X	—			1
	Alarms	One for each type of alarm										
Indicator	Hours	Total operating time (hours)										
	Contact wear	%					X	X	—			1
Load profile	Hours at different load levels	% of hours in four current ranges: 0–49% I_N , 50–79% I_N , 80–89% I_N and $\geq 90\% I_N$					X	X	—			1
							X	X	—			

¹ Available through the communication network only.

² The BSCM (page 82) is required for these functions.

PowerPact™ H-, J-, and L-Frame Circuit Breakers Trip Units

Additional technical characteristics:

- Contact wear
Each time PowerPact H-, J-, and L-frame circuit breakers open, the Micrologic 5 / 6 trip unit measures the interrupted current and increments the contact-wear indicator as a function of the interrupted current, according to test results stored in memory. Breaking under normal load conditions results in a very slight increment. The indicator value may be read on the front display module. It provides an estimation of contact wear calculated on the basis of the cumulative forces affecting the circuit breaker. When the indicator reaches 80%, it is advised to replace the circuit breaker to ensure the availability of the protected equipment.
- Circuit breaker load profile
Micrologic 5 / 6 trip units calculate the load profile of the circuit breaker protecting a load circuit. The profile indicates the percentage of the total operating time at four current levels (% of I_n):
 - 0 to 49% I_n
 - 50 to 79% I_n
 - 80 to 89% I_n
 - $\geq 90\%$ I_n .This information can be used to optimize use of the protected devices or to plan ahead for expansion.

Motor Circuit Protectors (AC Only)

See Section 5 for information about PowerPact H-, J- and L-frame electronic motor circuit protectors (MCP) with trip units:

- Micrologic 1.3 M
- Micrologic 2 M



Section 7—Accessories for Micrologic™ Trip Units

Display Options

Front Display Module Functions (FDM121) (Micrologic 5 / 6 A or E Trip Units Only)

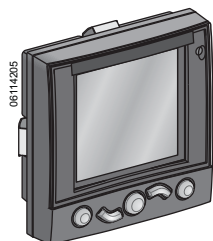

The front display module (FDM121) can be integrated in the PowerPact™ H-, J-, and L-frame circuit breaker system. It uses the sensors and processing capacity of the Micrologic trip unit to display measurements, demand, power quality and maximum/minimum values along with alarms, histories, and maintenance indicators.

It is easy to use and requires no special software or settings and is immediately operational when connected to the PowerPact H-, J-, and L-frame circuit breakers by a simple cable.

The FDM121 is a large display, but requires very little depth. The anti-glare graphic display screen is backlit for easy reading even under poor ambient lighting and at sharp angles.

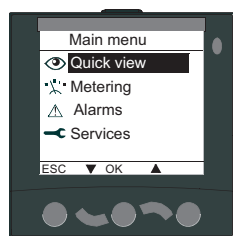

FDM121 Display



Surface Mount Accessory

Table 65: Characteristics

Screen	Size	96 x 96 x 30 mm
	Installation	Requires 10 mm behind the door (or 20 mm when the 24 Vdc power supply connector is used).
	Backlighting	White
	Viewing Angle	Vertical $\pm 60^\circ$, horizontal $\pm 30^\circ$
	Resolution	High: excellent reading of graphic symbols.
Alarm LED	Flashing orange	Alarm pick-up
	Steady orange after operator reset	Alarm condition persists.
Operating temperature	14°F to 131°F (-10 °C to +55 °C).	
Certifications	UL, CSA, CE	
24 Vdc power supply	Tolerances 24 V -20% +10% (19.2 V to 26.4 V)	When the FDM121 is connected to the communication network, the 24 Vdc is supplied by the communication network wiring.
Power Requirements	40 mA, 24 Vdc	
Mounting	Standard door cut-out 92 x 92 mm. Attached using clips.	To avoid a cut-out in the door, a surface-mount accessory is available for surface mounting by drilling two 22 mm diameter holes.
Degree of protection	NEMA12 / IP54 in front.	NEMA12 / IP54 is maintained after mounting by using the supplied gasket during installation.

Mounting

The FDM121 is easily installed in equipment.

- Standard door cut-out 3.62 x 3.62 in. (92 x 92 mm).
- Attached using clips.

To avoid a cut-out in the door, an accessory is available for surface mounting by drilling only two 0.87 in. (22 mm) diameter holes.

The FDM121 degree of protection is NEMA12 / IP54 in front. NEMA12 / IP54 is maintained after mounting by using the supplied gasket during installation.



PowerPact™ H-, J-, and L-Frame Circuit Breakers Accessories for Micrologic™ Trip Units

Display of Micrologic Trip Unit Measurements and Alarms

The FDM121 is intended to display Micrologic 5 / 6 trip unit measurements, alarms and operating information. It cannot be used to modify the protection settings. Measurements may be easily accessed through a menu.

All user-defined alarms are automatically displayed. The display mode depends on the priority level selected during alarm set-up:

- high priority: a pop-up window displays the time-stamped description of the alarm and the orange LED flashes
- medium priority: the orange Alarm LED goes steady on
- low priority: no display on the screen.

All faults resulting in a trip automatically produce a high-priority alarm, without any special settings required. In all cases, the alarm history is updated.

If power to the FDM121 fails, all information is stored in the Micrologic trip unit non-volatile memory. The data can be consulted using the communication network when power is restored.

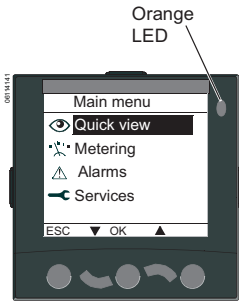

Status Indications and Remote Control

When the circuit breaker is equipped with the BSCM module (page 82), the FDM121 display can also be used to view circuit breaker status conditions:

- Auxiliary switch (OF): ON/OFF
- Alarm switch (SD): trip indication
- Overcurrent trip switch (SDE): fault-trip indication (overload, short-circuit, ground fault)

Electrical Connection

The FDM121 is equipped with:

- a 24 Vdc terminal block:
 - plug-in type with 2 wire inputs per point for easy daisy-chaining
 - power supply range of 24 V -20% (19.2 V) to 24 V +10% (26.4 V)
- two RJ45 jacks.

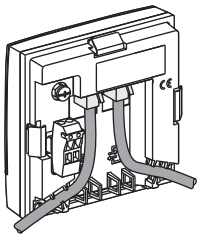

The Micrologic trip unit connects to the internal communication network terminal block on the PowerPact H-, J-, and L-frame circuit breakers using the pre-wired NSX cord. Connection to one of the RJ45 connectors on the FDM121 automatically establishes communication between the Micrologic trip unit and the FDM121 and supplies power to the Micrologic trip unit measurement functions.

When the second connector is not used, it must be fitted with a line terminator TRV00880.

Navigation

Five buttons are used for intuitive and fast navigation.

The “Context” button may be used to select the type of display (digital [text], bargraph, analog).

The user can select the display language (Chinese, English, French, German, Italian, Portuguese, Spanish, etc.) Other languages can be downloaded.

Screens



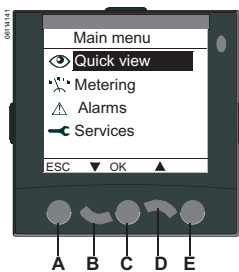

Main menu

When powered up, the FDM121 screen automatically displays the ON/OFF status of the device.

When not in use, the screen is not backlit. Backlighting can be activated by pressing one of the buttons. It goes off after three minutes.



PowerPact™ H-, J-, and L-Frame Circuit Breakers Accessories for Micrologic™ Trip Units

 Quick view	Provides access to five screens that display a summary of essential operating information (I, U, f, P, E, THD, circuit breaker On / Off).
 Metering	Used to display the measurement data (I, U-V, f, P, Q, S, E, THD, PF) with the corresponding min/max values.
 Alarms	Displays active alarms and the alarm history
 Services	Provides access to the operation counters, energy and maximum reset function, maintenance indicators, identification of modules connected to the internal bus and FDM121 internal settings (language, contrast, etc.)

Fast access to essential information:

- “Quick view” provides access to five screens that display a summary of essential operating information (I, V, f, P, E, THD, circuit breaker On / Off).

Access to detailed information

- “Metering” can be used to display the measurement data (I, U-V, f, P, Q, S, E, THD, PF) with the corresponding min/max values.
- Alarms displays active alarms and the alarm history
- Services provides access to the operation counters, energy and maximum reset function, maintenance indicators, identification of modules connected to the internal bus and FDM121 internal settings (language, contrast, etc.)

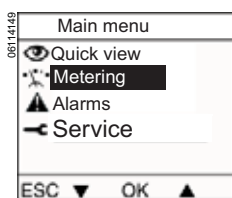

Quick View

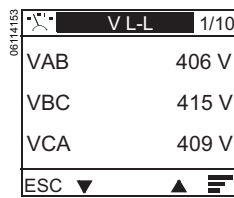

Metering Sub-Menu

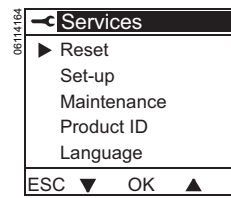

Services

Catalog Numbers

Table 66: Front Display Module Catalog Numbers

Description	Catalog No.
FDM121	STRV00121
FDM121 Mounting Accessory	TRV00128

PowerPact™ H-, J-, and L-Frame Circuit Breakers Accessories for Micrologic™ Trip Units

Circuit Breaker Communication Network Options

All PowerPact H-, J-, and L-frame circuit breakers devices can be equipped with the communication function using a pre-wired connection system and a Modbus™ communication interface module. The interface module can be connected directly or through the front display module (FDM121).

The PowerPact H-, J-, and L-frame circuit breakers can be integrated in a Modbus communication network. Four functional levels can be used separately or combined to adapt to all supervision requirements.

Level	Function
Communication of status indications	<p>Compatible with PowerPact H-, J- and L-frame circuit breakers and automatic switches. Use the BSCM module to access the following information:</p> <ul style="list-style-type: none"> • ON/OFF position • trip indication • fault-trip indication
Communication of commands	<p>Available on all circuit breakers and automatic switches with communicating motor operators, the remote control can be used to:</p> <ul style="list-style-type: none"> • open • closed • reset
Communication of measurements with Micrologic 5 / 6 A or E trip unit	<p>This level provides access to:</p> <ul style="list-style-type: none"> • instantaneous and demand values • maximums/minimums • energy metering • demand current and power • power quality
Communication of operating assistance with Micrologic 5 / 6 A or E trip unit	<p>This level also provides access to:</p> <ul style="list-style-type: none"> • protection and alarm settings • time-stamped histories and event tables • maintenance indicators

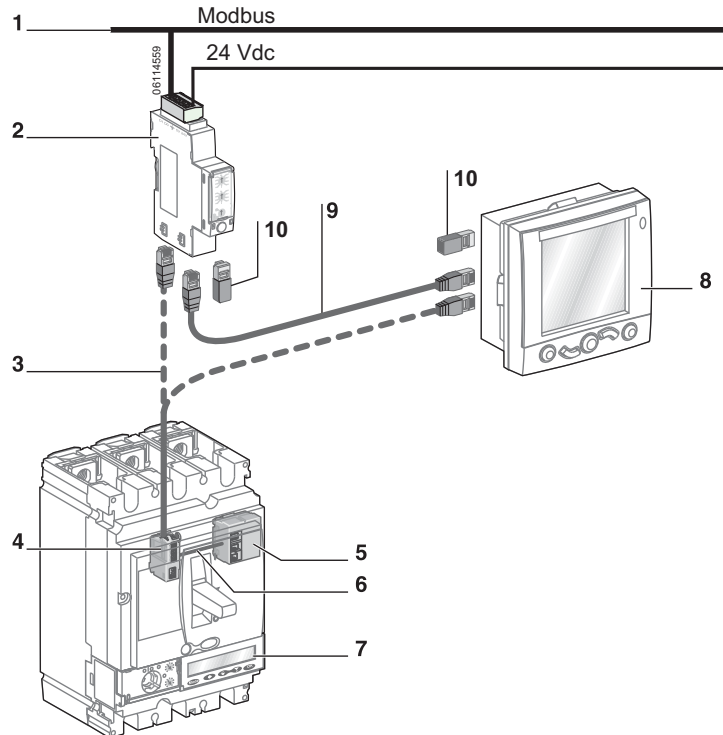

PowerPact H-, J-, or L-frame circuit breaker is connected to the Modbus communication interface module (IFM) or front display module (FDM121) through the internal terminal block for the NSX cord.

The front display module is connected to the Modbus communication interface module by a communication cable with RJ45 connectors on both ends.

1. Modbus network
2. Modbus communication interface module
3. NSX cord
4. Internal terminal block for communication using the NSX cord
5. BSCM module
6. Prefabricated wiring
7. Micrologic trip unit
8. FDM121 display
9. RJ45 cable
10. Line terminator (for unused connectors, if applicable)

Modbus Communication Interface Module (IFM)

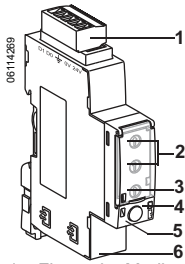

1. Five-point Modbus and 24 Vdc connector
2. Two Modbus address rotary switches (1 to 99)
3. Modbus traffic LED
4. Lock-out to disable writing to the trip unit
5. Test LED
6. Test button
7. Two connectors for RJ45 cable

Functions

This module, required for connection to the network, contains the Modbus address (1 to 99) declared by the user using the two rotary switches in front. It automatically adapts (baud rate, parity) to the Modbus network in which it is installed.

It is equipped with a lock-out switch to enable or disable operations involving writing to Micrologic trip unit, (such as reset, counter reset, setting modifications, device opening and closing commands).

There is a built-in test function to check the connections of the Modbus communication interface module with the Micrologic trip unit and front display module.

Mounting

The module is mounted on a DIN rail. A number of modules may be clipped one next to the other. For this, a stacking accessory (shown below) is available for fast clip-connection of both the Modbus link and the 24 Vdc supply.

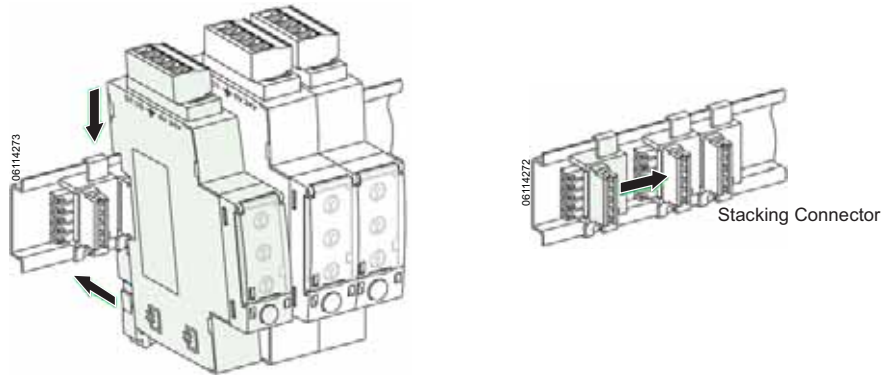

The Modbus communication interface module supplies 24 Vdc to the corresponding Micrologic trip unit, front display module, and BSCM module. Module power requirements is 60 mA / 24 Vdc.

Catalog Numbers

Table 67: IFM Catalog Numbers

Description	Catalog No.
Modbus Communication Interface Module (IFM)	STRV00210
Stacking Connectors for IFM (10)	TRV00217

Isolated Modbus Repeater Module

Since Modbus interface modules (part number STRV00210) are not isolated, an isolated Modbus Repeater Module needs to be inserted between the Modbus network inside the equipment and the Modbus network outside the equipment.

Table 68: Catalog Number

Description	Catalog No.
Isolated Modbus Repeater Module	STRV00211

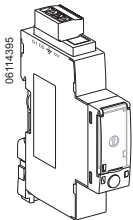

PowerPact™ H-, J-, and L-Frame Circuit Breakers Accessories for Micrologic™ Trip Units

NSX Cord

Micrologic trip units are connected to the Modbus communication interface module (IFM) or front display module through the internal terminal block for the NSX cord equipped with an RJ45 connector.

The NSX cord is available in two cable lengths:

- 4.27 ft (1.3 m)
- 9.84 ft (3 m)

Lengths up to 32.8 ft (10 m) are possible using extensions.

- For voltage $V \leq 480$ V, available in 3 prefabricated lengths: 0.35 m, 1.3 m and 3 m.
- For voltages $V > 480$ V, a special 1.3 m cable with an insulation accessory is required.
- A set of cables with RJ45 connectors is available to adapt to different distances between devices.

Table 69: NSX Cord Catalog Numbers

Description	Catalog No.
NSX Cord 4.27 ft (1.3 m), $V \leq 480$ V	S434201
NSX Cord 9.84 ft (3 m), $V \leq 480$ V	S434202
NSX Cord 4.27 ft (1.3 m), $V > 480$ V	S434204
NSX Cord 9.84 ft (3 m), $V > 480$ V	S434303

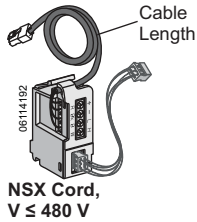

NSX Cord,
 $V \leq 480$ V

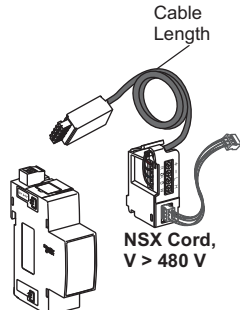

NSX Cord,
 $V > 480$ V

Isolation Module
for NSX Cord
with $V > 480$ V

Breaker Status and Control Module (BSCM)

Functions

The optional BSCM Breaker Status & Control Module is used to acquire device status indications and control the communicating remote-control function. It includes a memory used to manage the maintenance indicators.

Status indications

Indication of device status:

Auxiliary switch (OF), alarm switch (SD), and overcurrent trip switch (SDE).

Maintenance indicators

The BSCM manages the following indicators:

- mechanical operation counter
- electrical operation counter
- history of status indications.

It is possible to assign an alarm to the operation counters.

Controls

The BSCM can be used to carry out communicating remote control operations using the communicating motor operator (open, close and reset) in different modes (manual, auto).

Mounting

The BSCM can be installed on all PowerPact H-, J-, and L-frame circuit breakers and automatic switches with Micrologic trip units. It simply clips into the auxiliary contact slots. It occupies the slots of one auxiliary switch (OF) and one overcurrent trip switch (SDE). The BSCM is supplied with 24 Vdc power automatically through the NSX cord when the communication network is installed.

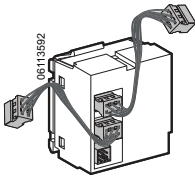

PowerPact™ H-, J-, and L-Frame Circuit Breakers Accessories for Micrologic™ Trip Units

Catalog Numbers

Table 70: BSCM Catalog Numbers

Description	Catalog No.
Replacement BSCM	S434205
BSCM with NSX Cord 1.3 m, $V \leq 480$ V	S434201BS
BSCM with NSX Cord 3 m, $V \leq 480$ V	S434202BS
BSCM with NSX Cord 1.3 m, $V > 480$ V	S434204BS
BSCM with NSX Cord 3 m, $V > 480$ V	S434303BS

24 Vdc Power-Supply Terminal Block

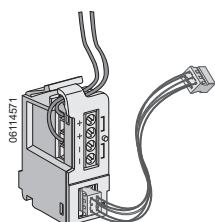

24 Vdc Terminal Block

The Micrologic 5/6 trip unit display is operational when current is flowing through the circuit breaker. To power the Micrologic 5/6 trip unit when the trip unit is not connected to an FDM121 or to the communication network, a 24 Vdc power-supply terminal block can be installed only on Micrologic 5/6 trip units. When used, it excludes connection of an NSX cord.

Table 71: 24 Vdc Catalog Number

Description	Catalog No.
24 Vdc Terminal Block Unit Mount	S434210

External 24 Vdc Power-Supply Module

An external 24 Vdc power supply is required for installation in a communication network, whatever the type of trip unit.

On installations without a communication network, the power supply is available as an option for Micrologic 5/6 trip units in order to:

- modify settings when the circuit breaker is open
- display measurements when the current flowing through the circuit breaker is low (15 to 50 A depending on the rating)
- maintain the display of the cause of tripping and interrupted current.

A single external 24 Vdc supply may be used for the entire network, depending on the number of devices in the communication network. The required characteristics are:

- output voltage: 24 Vdc \pm 5%
- ripple: \pm 1%

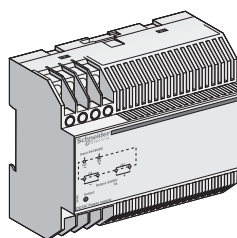

External 24 Vdc Power-Supply Module

Table 72: Available External Power-Supply Modules (1 A)

Available External Power-Supply Modules		Input Voltage	Output Power	Cat. No.
Power supply	Vdc (\pm 5%)	24–30	5 VA/5W	685823
		48–60		685824
		100–125		685825
	Vac (+10%, -15%)	110–130		685826
		200–240		685827
		380–415		685829

To determine the required output current of the 24 Vdc power supply, it is necessary to sum up the currents consumed by the different loads supplied.

PowerPact™ H-, J-, and L-Frame Circuit Breakers Accessories for Micrologic™ Trip Units

Table 73: Power Requirements

Module	Typical Consumption 24 Vdc @ 68°F (20°C)	Maximum Consumption 19.2 Vdc @ 140°F (60°C)
Micrologic 5/6 trip units	30 mA	55 mA
BSCM	9 mA	15 mA
FDM121	21 mA	30 mA
IFM	21 mA	30 mA
Isolated Modbus Repeater Module	15 mA	19 mA

For installation recommendations, see page page 137

Battery Module

The battery module is a back-up supply for the external power-supply module. The input/output voltages are 24 Vdc and it can supply power for approximately three hours (100 mA).

Table 74: Battery Module

Description	Catalog No.
Battery Module	685831



Battery Module

Pocket Tester

The pocket tester connects to the Micrologic trip unit test connector. It powers up the Micrologic trip unit and the Ready LED. It supplies the screen, allows settings to be made using the keypad, and provides thermal imaging inhibit functions.

Table 75: Pocket Tester

Description	Catalog No.
Pocket Tester	S434206

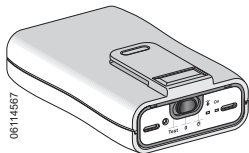

Pocket Tester

The pocket tester runs off of two Alkaline AA batteries.

UST Test Adapter (UTA) Tester for Test and Maintenance

The UTA Tester includes:

- configuration and maintenance module
- power supply (110–220 Vac / 50-60 Hz 24 Vdc - 1 A)
- special Micrologic cable for connection to the trip-unit test connector
- standard USB cable
- standard RJ45 cable
- user manual

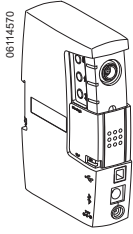

UTA Tester Module

Table 76: UTA Tester Catalog Numbers

Description	Catalog No.
UTA Tester (complete)	STRV00910
Spare 110-240 V power supply	TRV00915
Spare Micrologic cable	TRV00917
Spare UTA Tester Module	STRV00911
Bluetooth/Modbus Option for UTA Tester	SVW3A8114

Included in the UTA Tester, the UTA Tester module tests Micrologic trip unit operation and provides access to all parameters and settings. It connects to the Micrologic trip unit test connector and can operate in two modes.

- Stand-alone mode to:
 - supply the Micrologic trip unit with power and check operation using the Ready LED
 - Provides ground-fault inhibit and thermal memory inhibit
- PC mode, connected to a PC with a USB or Bluetooth link. This mode provides access to protection settings, alarm settings and readings of all indicators. Using the associated RSU software utility, it is possible to store, in a dedicated file for each device, all the data that can be transferred to another device.

This mode also offers operating-test functions:

 - check on trip time delay (trip curve)
 - check on non-tripping time (coordination)
 - check on ZSI (Zone Selective Interlocking) function
 - alarm simulation
 - display of setting curves
 - display of currents
 - printing of test reports
 - optional Bluetooth link (to PC).

PowerPact™ H-, J-, and L-Frame Circuit Breakers Accessories for Micrologic™ Trip Units

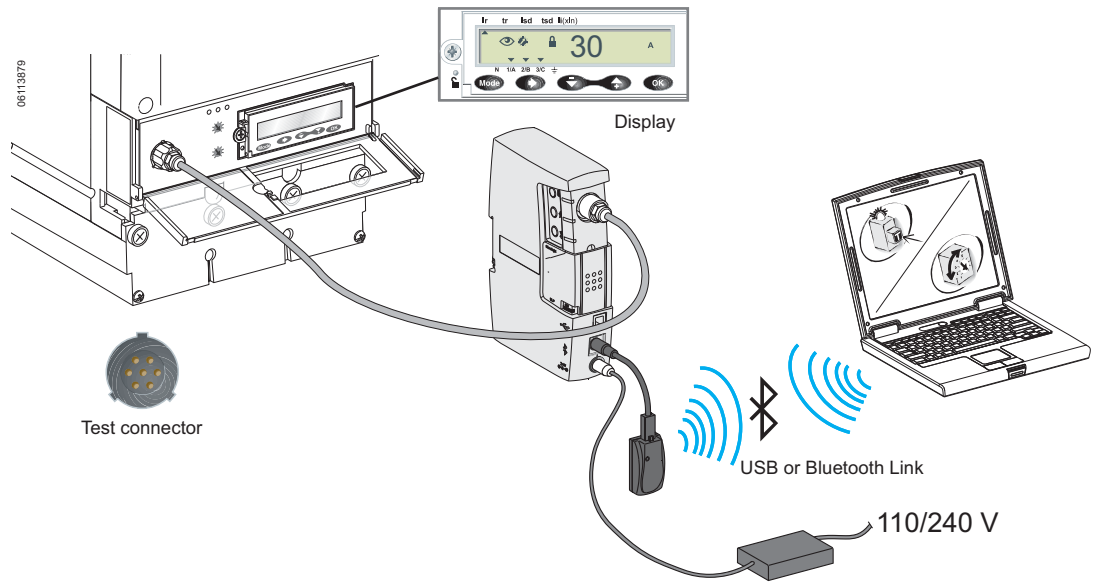

Universal Logic Plug System



The Universal Logic Plug (ULP) system allows the PowerPact H-, J- and L-frame circuit breakers to become metering and supervision tools to assist for energy efficiency. For easy connection of the different modules, the prefabricated cables are identified by a ULP symbol. The connection points on compatible modules are marked in the same manner.

Table 77: ULP Accessories Catalog Numbers

Description	Qty	Catalog No.
RJ45 connectors, female/female	10	TRV00870
ULP Line termination	10	TRV00880
RJ45/RJ45 male cord L= 0.3 m	10	TRV00803
RJ45/RJ45 male cord L= 0.6 m	10	TRV00806
RJ45/RJ45 male cord L = 1 m	5	TRV00810
RJ45/RJ45 male cord L = 2 m	5	TRV00820
RJ45/RJ45 male cord L = 3 m	5	TRV00830
RJ45/RJ45 male cord L = 5 m	1	TRV00850
Modbus Line Terminations	2	VW3A8306DRC

For more information about the ULP System, see page 136 or bulletin 48940-329-01, *ULP (Universal Logic Plug) Connection System—User Guide*.

Circuit Breaker Communication Networks and Software

Modbus™ Communication Network

Modbus is the most widely used communication protocol in industrial networks. It operates in master-slave mode. The devices (slaves) communicate one after the other with a gateway (master).

Masterpact™ and PowerPact™ circuit breakers with Micrologic trip units, PowerLogic™ and Sepam™ products all operate with this protocol. A Modbus network is generally implemented on an LV or MV system. Micrologic trip units use the Modbus communication protocol, compatible with ION-Enterprise PowerLogic supervision systems.

Depending on the data monitored and the desired refresh rate, a Modbus network connected to a gateway can serve 4 to 16 devices. For larger installations, a number of Modbus networks can be connected to an Ethernet® network (TCP/IP/Modbus protocol) through their gateways.

The downloadable RSUsoftware application facilitates implementation of communication network functions.

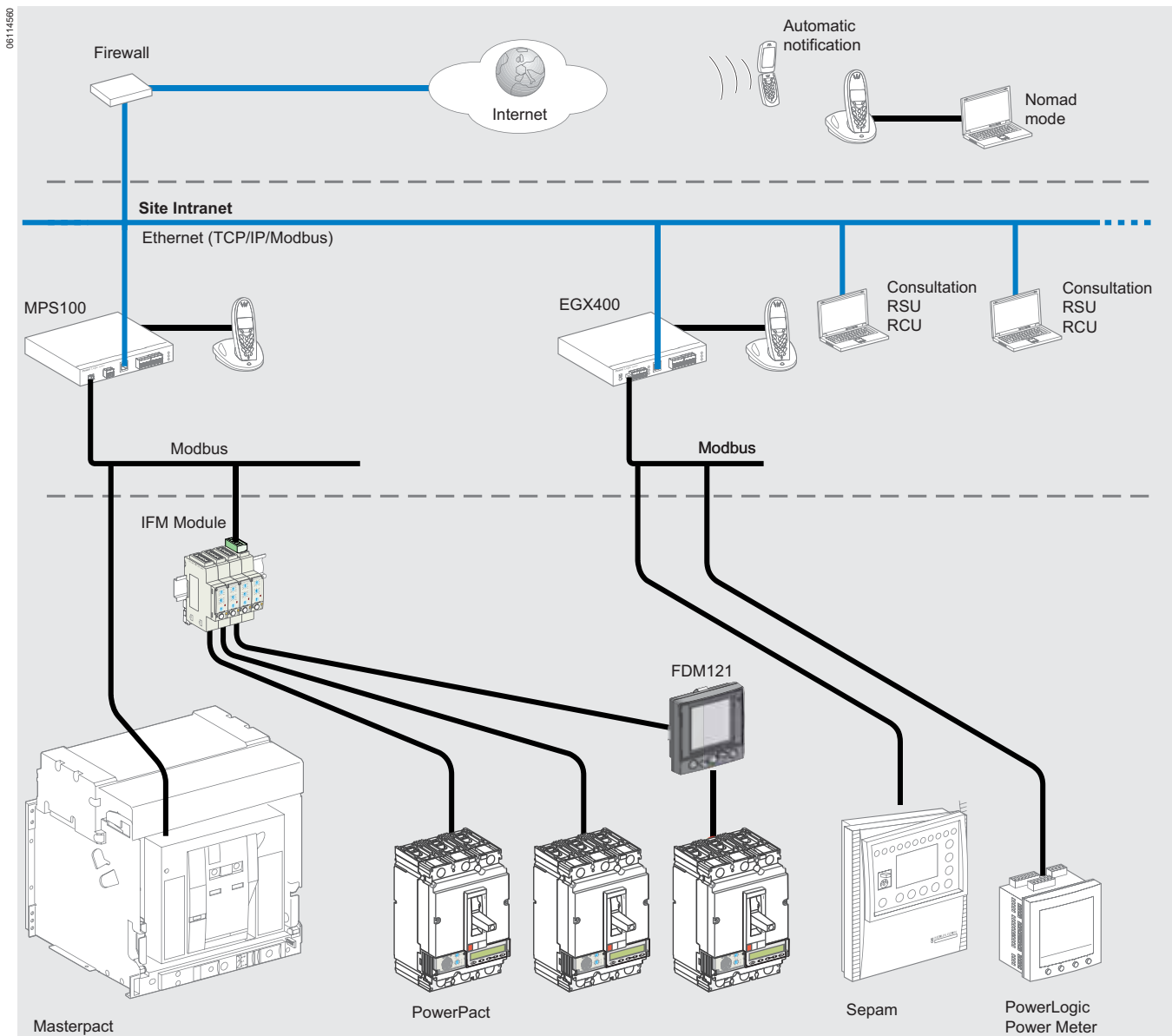

PowerPact™ H-, J-, and L-Frame Circuit Breakers Accessories for Micrologic™ Trip Units

Supervision Software

Schneider Electric™ electrical installation supervision, management and expert system software integrates PowerPact H-, J-, and L-frame electronic circuit breakers identification modules.

Types of Software

Micrologic trip unit communication network functions are designed to interface with software dedicated to electrical installations:

- installation supervision
- electrical installation supervision
- power system management: electrical engineering expert systems
- process control
- SCADA (Supervisory Control & Data Acquisition), EMS (Enterprise Management System) or BMS (Building Management System) type software.

Remote Setting Utility (RSU)

The downloadable Micrologic Trip Unit Utility, RSU, facilitates the implementation of communication network functions.

- The RSU is available to assist in starting up a communicating installation. The software can be downloaded from the Schneider Electric internet site.
- The “Live update” function enables immediate updating to obtain the most recent upgrades. These easy-to-use utilities include starting assistance and online help. They are compatible with Microsoft Windows 2000, XP, Vista and Windows 7.



RSU mini-supervision screen for current measurements.

PowerPact™ H-, J-, and L-Frame Circuit Breakers Accessories for Micrologic™ Trip Units

The RSU can be used to set the protection functions and alarms for each Masterpact™ and PowerPact device.

After connection to the network and entry of the circuit-breaker Modbus address, the software automatically detects the type of trip unit installed.

There are two possible operating modes. For each selected circuit breaker, the user can do the following.

Operating Mode	Operation	Description
Off-Line with the Software Disconnected from the Communication Network	Determine the protection settings	The settings are carried out on a screen that shows the front of the trip unit. The Micrologic trip unit setting rotary switches, keypad and screen are simulated for easy use of all Micrologic trip unit setting functions.
	Save and duplicate the protection settings	Each configuration created can be saved for subsequent device programming. It can also be duplicated and used as the basis for programming another circuit breaker.
On-Line with the Software Connected to the Network	Display the current settings The software displays the trip unit and provides access to all settings.	The software displays the trip unit and provides access to all settings.
	View the corresponding protection curves	A graphic curve module in the software displays the protection curve corresponding to the settings.
	Display the current settings Modify settings in a secure manner	There are different levels of security: — password: by default, it is the same for all devices, but can be differentiated for each device — locking of the Modbus communication interface module which must be unlocked before the corresponding device can be set remotely — maximum settings limited by the positions of the two rotary switches on the trip unit. These rotary switches, set by the user, determine the maximum settings that can be made using the communication network. Settings are modified by: — either direct, on-line setting of the protection settings on the screen — or by loading the settings prepared in off-line mode. This is possible only if the positions of the rotary switches allow the new settings. All manual settings made subsequently on the device have priority.
	Program alarms	Up to 12 alarms can be linked to measurements or events. two alarms are predefined and activated automatically: — Micrologic 5 trip unit: overload (I_r) — Micrologic 6 trip unit: overload (I_r) and ground fault (I_g) thresholds, priorities and time delays can be set for 10 other alarms. They may be selected from a list of 91 alarms
	Set the outputs of the SDx relays	This is required when the user wants to change the standard configuration and assign different signals to the 2 outputs of the SDx relay.

To download the RSU software (LV4ST100):

- go to www.schneider-electric.com and do a search for LV4ST100.
- Click on LV4ST100, then click Software/Firmware under Downloads menu, then download.

Gateway

The gateway has two functions:

- access to the company intranet (Ethernet) by converting Modbus frames to the TCP/IP/Modbus protocol
- optional web page server for the information from the devices.

Examples include EGX300 and EGX100.

PowerPact™ H-, J-, and L-Frame Circuit Breakers Accessories for Micrologic™ Trip Units

Integration of PowerPact H-, J-, and L-frame Circuit Breakers

Micrologic trip unit communication network functions are designed to interface with software dedicated to electrical installations. PowerPact H-, J-, and L-frame circuit breakers are integrated using Modbus communication interface modules connected through FDM121 front display modules or NSX cords.

For easy connection of the different modules, the prefabricated cables are identified by ULP (Universal Logic Plug) symbols. The connection points on compatible modules are marked in the same manner.

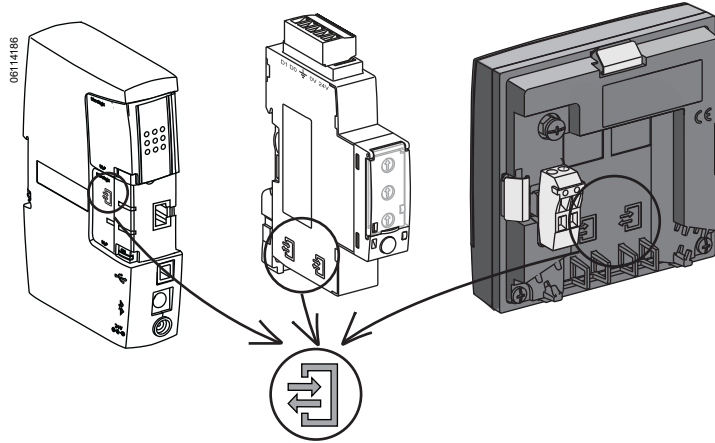

Schneider Electric™ Solutions

Electrical Equipment Supervision using Gateways such as the EGX300 Web Servers

- A simple solution for customers who want to consult the main electrical parameters of installed devices without dedicated software.
- Up to 16 devices are connected using Modbus communication interface modules to an MPS100 or EGX300 Ethernet gateway integrating the functions of a web page server. The embedded Web pages can be easily configured with just a few mouse clicks. The information they provide is updated in real time.
- The Web pages can be consulted using a standard Web browser on a PC connected through Ethernet to the company Intranet or remotely using a modem. Automatic notification of alarms and threshold overruns is possible using e-mail or SMS (Short Message Service).

SMS Electrical Engineering Expert System Software

PowerLogic™ SMS is a family of web-enabled software products for high-end power-monitoring applications. It is designed for large power systems.

SMS products offer detailed analysis of electrical events, long-duration data logging and extensive, economical report-building capabilities (such as power usage monitoring and tariff management).

A wide variety of screens can be displayed in real time, including more than 50 tables, analogue meters, bargraphs, alarms logs with links to display waveforms and predefined reports on energy quality and service costs.

PowerPact™ H-, J-, and L-Frame Circuit Breakers Accessories for Micrologic™ Trip Units

Electrical Installation Supervision using ION-Enterprise Software

- PowerLogic™ ION-Enterprise software is ideally suited to the supervision needs of small system applications, monitoring up to 32 devices.
- Installed on a PC under Windows, it represents a cost-effective and easy-to-implement power-monitoring solution that offers:
 - automatic detection of compatible devices
 - real-time monitoring of data including power requirements
 - a report generator with a number of pre-defined reports that can be exported to Excel
 - cost allocation
 - time-stamped data-logging possibilities
 - Modbus serial and Modbus TCP/IP compatible communication.

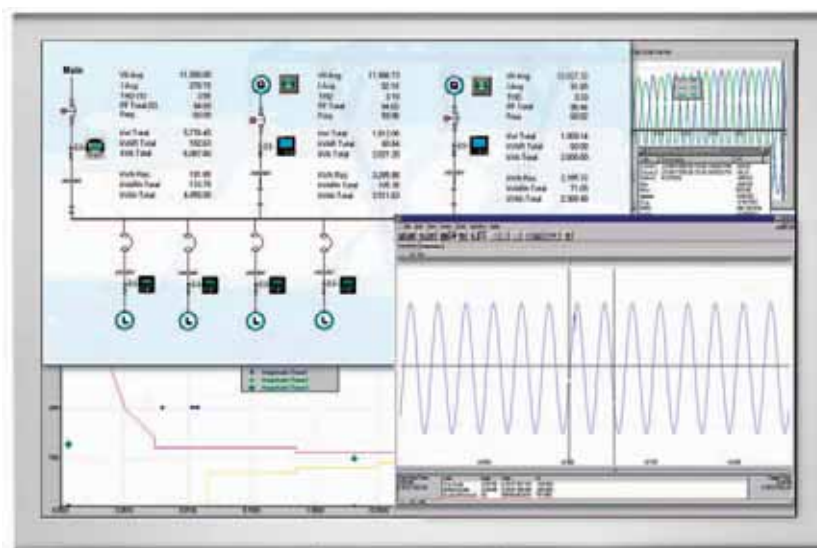

Other Software

PowerPact H-, J-, and L-frame devices can forward their measurement and operating information to special software integrating the electrical installation and other technical facilities:

- SCADA process control software: Vijeo CITECT
- BMS Building Management System software: Vista.

For more information, contact your local field office.

PowerPact™ H-, J-, and L-Frame Circuit Breakers Accessories for Micrologic™ Trip Units

External Neutral Current Transformer (ENCT)



External neutral current transformer

The external neutral current transformer is a sensor required for a three-pole circuit breaker in a system with a distributed neutral to measure the neutral current in order to:

- protect the neutral conductor
- protect against ground faults.

This current transformer can be connected to Micrologic 5 / 6 trip units. The transformer rating must be compatible with that of the circuit breaker.

Table 78: Current Transformers

Circuit Breaker	Rating	Catalog No.
H-Frame	60–100 A	S429521
	150 A	S430562
J-Frame	250 A	S430563
L-Frame	400–600 A	S432575

For installation recommendations, see page 136.



External Neutral Voltage Tap

External Neutral Voltage Tap (ENVT)

The external neutral voltage tap is required for Micrologic E power metering with a three-pole circuit breaker in a system with a distributed neutral. It is used to connect the neutral to the Micrologic trip unit to measure phase-to-neutral (Ph-N) voltages.

The ENVT is included with the Micrologic 5/6 electronic trip unit.

Zone Selective Interlock (ZSI) Module

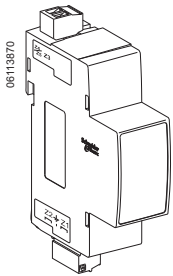

A ZSI terminal block may be used to interconnect a number of Micrologic trip units to provide zone selective interlocking for short-time (I_{sd}) and ground-fault (I_g) protection, without a time delay. For PowerPact H- and J-frame circuit breakers, the ZSI function is available only in relation to the upstream circuit breaker (ZSI out). For PowerPact L-frame circuit breakers, the ZSI function is available in relation to the upstream circuit breaker (ZSI out) and downstream circuit breakers (ZSI in)

Table 79: ZSI Catalog Number

Description	Catalog No.
ZSI Module	S434212

PowerPact™ H-, J-, and L-Frame Circuit Breakers Accessories for Micrologic™ Trip Units

I-Line™ Wiring Harness

Accessories installed in I-Line circuit breakers require the use of optional wiring harnesses (not provided). The wiring harness allows the accessory wiring to exit the circuit breaker through wiring channels in the side of the circuit breakers. Wire harnesses may also be used for unit-mount applications.

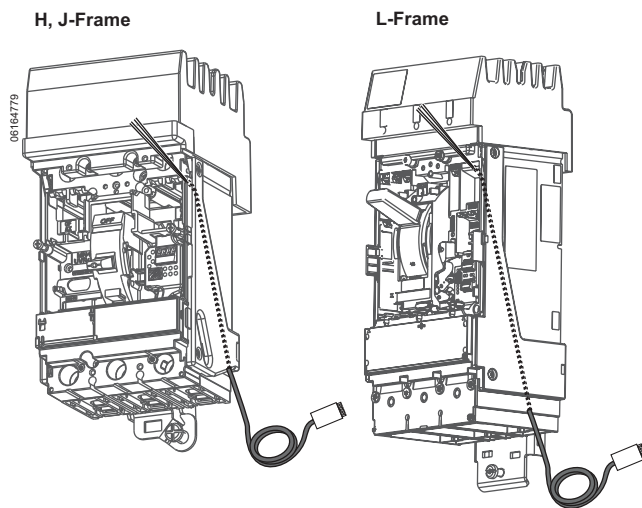

Table 80: Wiring Harness Catalog Numbers

Description	Catalog No.
Auxiliary Switch (OF) I-Line Wire Harness	S434500
Alarm Switch (SD)/Overcurrent Trip Switch (SDE) I-Line Wire Harness	S434501
SDx/SDTAM I-Line Wire Harness	S434502
Undervoltage Trip (MN) I-Line Wire Harness	S434503
Shunt Trip (MX) I-Line Wire Harness	S434504
24 Vdc Power Supply Terminal Block I-Line Wire Harness	S434505
Motor Operator (MT) I-Line Wire Harness	S434506
Communicating Motor Operator (MTc) I-Line Wire Harness	S434507
NSX Cord I-Line Wire Harness	S434508
ZSI (H/J-Frame, Out Only) I-Line Wire Harness	S434300
ZSI (L-Frame, In and Out) I-Line Wire Harness	S434301
ENCT I-Line Wire Harness	S434302

Section 8—Accessories and Auxiliaries

All PowerPact™ H-, J-, and L-frame circuit breakers and automatic switches have slots for the electrical auxiliaries

H- and J-Frame

- 4 indication contacts
 - 2 ON/OFF (auxiliary switches [OF1 and OF2])
 - 1 trip indication (alarm switch [SD])
 - 1 fault-trip indication (overcurrent trip switch [SDE])
- one remote-tripping release
 - either 1 undervoltage trip (MN)
 - or 1 shunt trip (MX)

L-Frame

- 5 indication contacts
 - 3 ON/OFF auxiliary switches (OF1, OF2, and OF3)
 - 1 trip indication (alarm switch [SD])
 - 1 fault-trip indication (overcurrent trip switch [SDE])
- one remote-tripping release
 - either 1 undervoltage trip (MN)
 - or 1 shunt trip (MX)

Circuit breakers equipped with Micrologic™ trip units may be equipped with a fault-trip indication to identify the type of fault by installing

- one indication module with two outputs (see page 98)
 - either an SDx module with Micrologic 3.x / 5.x A or E / 6.x A or E
 - or an SDTAM module with Micrologic 2.x M.

This module occupies the slots of one auxiliary switch (OF) contact and an undervoltage trip (MN)/shunt trip (MX).

All these auxiliaries may be installed with a motor operator.

Communication Network

Communication networks require specific auxiliaries.

Communication of status indications

- 1 BSCM module
- 1 NSX cord (internal terminal block) for both communication and 24 Vdc supply to the BSCM.

Communication of status conditions is compatible with a standard motor operator.

Communication of status indications and controls requires, in addition to the previous auxiliaries:

- 1 communicating motor operator connected to the BSCM.

Communication of measurements is available on Micrologic 5 / 6. The system consists of:

- 1 NSX cord (internal terminal block) for both communication and 24 Vdc supply to the Micrologic.

Communication of measurements is compatible with a standard or communicating motor operator.

Communication of status indications, controls and measurements is available on Micrologic 5 / 6. The system consists of:

- 1 BSCM module
- 1 NSX cord (internal terminal block) for both communication and 24 Vdc supply to the BSCM and the Micrologic
- 1 communicating motor operator connected to the BSCM.

Installation of SDx or SDTAM is compatible with communication network.

PowerPact™ H-, J-, and L-Frame Circuit Breakers Accessories and Auxiliaries

Table 81: Standard Auxiliary Possibilities Based on Trip Unit

Type	Trip Unit	Auxiliary Possibilities
H-Frame J-Frame	Micrologic 3	
H-Frame J-Frame	Micrologic 5 Micrologic 6	<p><i>The SDx or SDTAM uses the OF1 and MN/MX slots. External connection is made via a terminal block in the OF1 slot. The 24 Vdc supply provides for the Micrologic 5 / 6 display when the device is OFF or under low-load conditions.</i></p>
L-Frame	Micrologic 1.3 M Micrologic 3	
L-Frame	Micrologic 5 Micrologic 6	<p><i>External connection is made using a terminal block in the reserved slot. The 24 V DC supply provides for the Micrologic 5 / 6 display when the device is OFF or under low-load conditions.</i></p>

PowerPact™ H-, J-, and L-Frame Circuit Breakers Accessories and Auxiliaries

Table 82: Communication Network Auxiliary Possibilities Based on Trip Unit

Type	Trip Unit	Auxiliary Possibilities
H-Frame J-Frame	Micrologic 3	<p>Communication of status indications and controls</p>
H-Frame J-Frame	Micrologic 5 Micrologic 6	<p>Communication of measurements with or without FDM121 display</p> <p>OR</p> <p>Communication of status indications, controls and measurements with or without FDM121 display</p>
L-Frame	Micrologic 1.3 M Micrologic 3	<p>Communication of status indications and controls</p>
L-Frame	Micrologic 5 Micrologic 6	<p>Communication of status indications</p> <p>OR</p> <p>Communication of status indications, controls and measurements with or without FDM121 display</p>

Accessory Connections

Electrical accessories are fitted with numbered terminal blocks for wires with the following maximum size:

- 16 AWG (1.5 mm²) for auxiliary switches (OF1 or OF2), and shunt trip (MX) or undervoltage trip (MN)
- 14 AWG (2.5 mm²) for the motor operator

Auxiliary switch wiring exits fixed mounted devices through a knock-out in the front cover.

NOTE: See page 119 for plug-in and page 121 for drawout options.

Auxiliary and Alarm Indication Contacts

Auxiliary indication contacts provide remote information of the circuit breaker status and can thus be used for indications, electrical locking, relays, etc.



Auxiliary Switch (OF)/
Alarm Switch (SD)

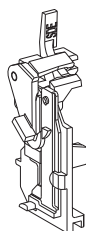

Overcurrent Trip
Switch Actuator (SDE)

Table 83: Auxiliary and Alarm Indication Contacts

Applications	<p>Open/Closed—Auxiliary Switches (OF)</p> <ul style="list-style-type: none"> • Indicates the position of the circuit breaker contacts <p>Trip Indication—Alarm Switch (SD)</p> <ul style="list-style-type: none"> • Indicates that the circuit breaker has tripped due to an overload, short circuit or ground fault, the operation of a shunt trip or undervoltage trip or the “push-to-trip” button • Resets when the circuit breaker is reset <p>Overcurrent Trip Switch (SDE)</p> <ul style="list-style-type: none"> • Indicates that the circuit breaker has tripped due to an overload, short circuit or ground fault • Resets when the circuit breaker is reset <p>The above switches are also available in low-level versions (with gold flash plating) capable of switching very low loads (e.g., for controlling PLCs or electronic circuits)</p> <p>Rotary Handle Indicator: CAO (early-break) and CAF (early-make)</p> <ul style="list-style-type: none"> • Fitted in the rotary handle module (see page 106)
Installation & Connection	<ul style="list-style-type: none"> • The auxiliary switch (OF), alarm switch (SD), and overcurrent trip switch (SDE) indication contacts snap into cavities behind the front accessory cover of the circuit breaker. • One model serves for all indication functions depending on where it is fitted in the circuit breaker. • The overcurrent trip switch (SDE) in a circuit breaker equipped with a thermal-magnetic or Micrologic 1/2/3 trip unit requires the SDE actuator.
Standards	<ul style="list-style-type: none"> • The internal accessories comply with requirements of Underwriters Laboratories® Inc. (UL®). • UL 489 and Canadian Standard Association C22.2 No. 5-02 Standards. • All internal accessories are Listed for field installation per UL file E103955 and Certified under CSA file LR 69561. • Auxiliary indicator contacts comply with UL 489, CSA C22.2 No. 5-02 and IEC 60947-5 Standards. “Low-level” indicator contacts are not UL Recognized.

Table 84: Electrical Characteristics

Characteristic	Standard		Low-Level ¹	
	AC	DC	AC	DC
Supplied as Standard (Form C)	4		4	
Maximum Number of Contacts	4		4	
Rated Thermal Current	6 A		5 A	
Maximum Load	100 mA at 24 V		1 mA at 4 V	
Operational Current	AC	DC	AC	DC
24 V	6 A	6 A	5 A	5 A
48 V	6 A	2.5 A	5 A	2.5 A
110 V	6 A	0.6 A	5 A	0.6
220/240 V	6 A	—	5 A	—
250 V	—	0.6 A	5 A	0.3 A
380/440 V	6 A	—	5 A	—
480 V	6 A	—	5 A	—
660/690 V	6 A	—	—	—

¹ If the maximum voltage and current is exceeded, the low-level function of the switch will be lost but the switch will continue to function as a standard switch.

PowerPact™ H-, J-, and L-Frame Circuit Breakers Accessories and Auxiliaries

Table 85: Auxiliary Switch Catalog Numbers

Contacts	Factory-Installed Suffix	Field-Installable Kit No.	Kit Qty.
1A/1B Standard	AA	S29450	1
2A/2B Standard	AB	S29450	2
1A/1B Low-Level (Gold)	AE	S29452	1
2A/2B Low-Level (Gold)	AF	S29452	2

Table 86: Alarm/Overcurrent Trip Switch Catalog Numbers

Suffix	Switch	Kit No.	Kit Qty.
PowerPact L-Frame PowerPact H/J-Frame with Micrologic 5/6 trip units			
BC	Alarm Switch	S29450	1
BH	Alarm Switch Low-Level	S29452	1
BD	Overcurrent Trip Switch Standard	S29450	1
BJ	Overcurrent Trip Switch Low-Level	S29452	1
BE	Alarm Switch and Overcurrent Trip Switch, Standard	S29450	2
BK	Alarm Switch and Overcurrent Trip Switch, Low-Level	S29452	2
PowerPact H/J-Frame with Thermal-Magnetic or Micrologic 1/2/3 trip units			
BC	Alarm Switch	S29450	1
BH	Alarm Switch, Low-Level	S29452	1
BD	Overcurrent Trip Switch, Standard SDE Actuator	S29450	1
		S29451	1
BJ	Overcurrent Trip Switch, Low-Level SDE Actuator	S29452	1
		S29451	1
BE	Alarm Switch and Overcurrent Trip Switch, Standard SDE Actuators	S29450	2
		S29451	2
BK	Alarm Switch and Overcurrent Trip Switch, Low-Level SDE Actuators	S29452	2
		S29451	2

SDx and SDTAM Modules for Micrologic

SDx and SDTAM are relay modules with two outputs. They send different signals depending on the type of fault. They may not be used together.

SDx Module

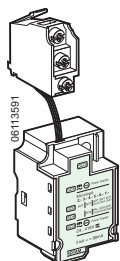

SDx module with terminal block.

The SDx module remotely monitors the trip or alarm conditions of PowerPact H-, J-, and L-frame circuit breakers equipped with electronic protection.

An SDx relay module installed inside the circuit breaker can be used to remote the overload trip signal.

This module receives the signal from the Micrologic electronic trip unit through an optical link and makes it available on the terminal block. The signal is cleared when the circuit breaker is closed. These outputs can be reprogrammed to be assigned to other types of tripping or alarm (see page 98).

The SDx module may be used in 400 Hz systems for voltages from 24 to 440V.

The SD2 output, available on all Micrologic trip units, corresponds to the overload-trip indication.

The SD4 output, available on Micrologic 5 / 6, is assigned to:

- overload pre-alarm (Micrologic 5)
- ground-fault trip indication (Micrologic 6)

These two outputs automatically reset when the device is closed (turned ON).

For Micrologic 5 / 6, the SD2 and SD4 outputs can be reprogrammed to be assigned to other types of tripping or alarm.

It is possible to assign a function output characteristics:

- latching with a time delay. Return to the initial state occurs at the end of the time delay
- permanent latching. Return to the initial state takes place through the communication function.

Static outputs: 24–415 V AC / Vdc; 80 mA max.

SDTAM Module

The SDTAM module, linked to the contactor controller, opens the contactor when an overload or other motor fault occurs, thus avoiding opening of the circuit breaker. The SDTAM module is specifically for the motor-protection Micrologic trip units 2 M (2.2 M and 2.3 M).

Micrologic 2 M

The SD4 output opens the contactor 400 ms before normal circuit-breaker opening in the following cases:

- overload (long-time protection for the trip class)
- phase unbalance or phase loss

The SD2 output serves to memorize contactor opening by SDTAM.

Output characteristics

Output reset can be:

- manual by a pushbutton included in the wiring diagram
- automatic after an adjustable time delay (1 to 15 minutes) to take into account the motor-cooling time

Static outputs: 24–415 Vac / Vdc; 80 mA max. a (+) 24–415 V.

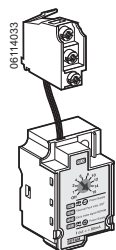

SDTAM module with terminal block.

PowerPact™ H-, J-, and L-Frame Circuit Breakers Accessories and Auxiliaries

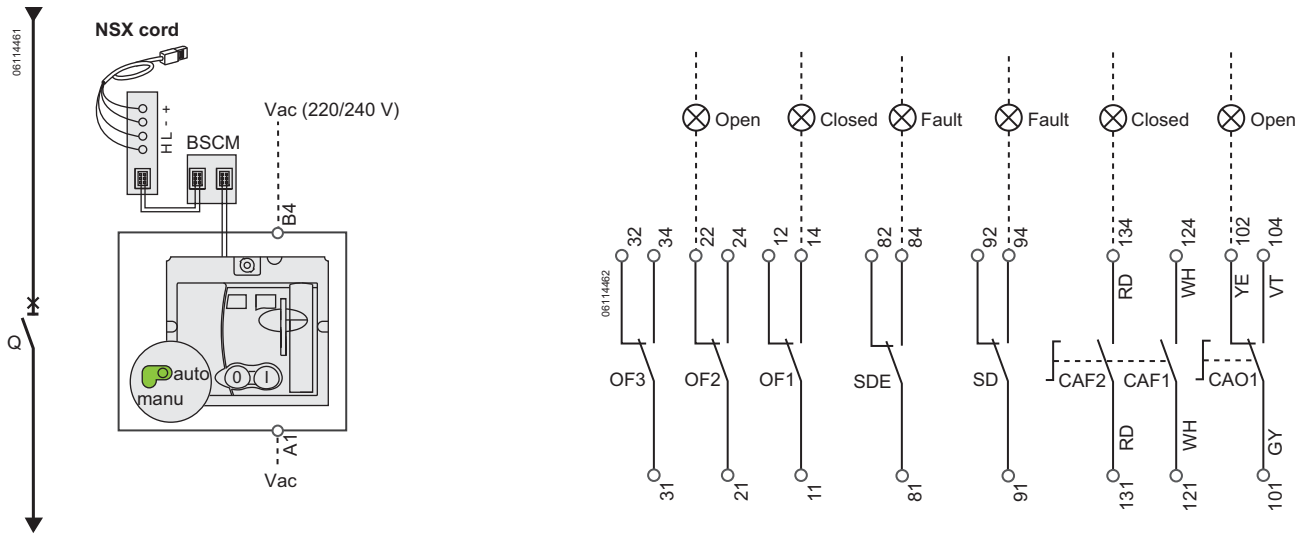

Schematic of the communicating motor operator .

Table 87: SDx and SDTAM Catalog Numbers

Contacts	Factory-Installed Suffix	Field-Installable Kit No.
SDx	V	S429532
SDTAM (motor trip units only)	V	S429424

Shunt Trip (MX) and Undervoltage Trip (MN)



A voltage release can be used to trip the circuit breaker using a control signal.

Table 88: Shunt Trip and Undervoltage Trip

Applications	Shunt Trip (MX)
	<ul style="list-style-type: none"> Trips the circuit breaker when the control voltage rises above 70% of its rated voltage Impulse type ≥ 20 ms or maintained control signals AC shunt trips are suitable for ground-fault protection when combined with a Class I ground-fault sensing element Continuous duty rated coil
Installation and Connection	Undervoltage Trip (MN)
	<ul style="list-style-type: none"> Trips the circuit breaker when the control voltage drops below a tripping threshold Drops out between 35% and 70% of the rated voltage Continuous duty rated coil Circuit breaker closing is possible only if the voltage exceeds 85% of the rated voltage. If an undervoltage condition exists, operation of the closing mechanism of the circuit breaker will not permit the main contacts to touch, even momentarily. This is commonly called "Kiss Free".
Operation	<ul style="list-style-type: none"> Accessories are common to H-, J-, and L-frame circuit breakers and snap into cavities under the front accessory cover of the circuit breaker Each terminal may be connected by one 18–14 AWG (1.0–2.5 mm²) stranded copper wire
	<ul style="list-style-type: none"> The circuit breaker must be reset locally after being tripped by shunt trip (MX) or undervoltage trip (MN) Tripping by the shunt trip or undervoltage trip has priority over manual (or motor operator) closing; in the presence of a standing trip order such an action does not result in any closing, even temporarily, of the main contacts Endurance: 50% of the rated mechanical endurance of the circuit breaker

Table 89: Electrical Characteristics

	AC	DC
Rated Voltage (V)	24, 48, 120, 208/277, 380/480, 525, 600	12, 24, 30, 48, 60, 125, 250
Power Requirements	Pickup (shunt trip)	< 5 W
	Seal-in (undervoltage trip)	< 5 VA
Clearing Time (ms)	< 50	< 50

Table 90: Shunt Trip and Undervoltage Trip Suffix Codes and Kit Numbers

Voltage	Shunt Trip (MX)		Undervoltage Release (MN)	
	Factory-Installed Suffix	Field-Installable Kit No.	Factory-Installed Suffix	Field-Installable Kit No.
24 Vac	SK	S29384	UK	S29404
48 Vac	SL	S29385	UL	S29405
120 Vac	SA	S29386	UA	S29406
208/277 Vac	SD	S29387	UD	S29407
380/480 Vac	SH	S29388	UH	S29408
525/600 Vac	SJ	S29389	UJ	S29409
12 Vdc	SN	S29382	UN	S29402
24 Vdc	SO	S29390	UO	S29410
30 Vdc	SU	S29391	UU	S29411
48 Vdc	SP	S29392	UP	S29412
60 Vdc	SV	S29383	UV	S29403
125 Vdc	SR	S29393	UR	S29413
250 Vdc	SS	S29394	US	S29414

Table 91: Adjustable and Fixed Time Delay Units for Undervoltage Trip

Rated Voltage	Field-Installable Kit No.	
	Adjustable	Fixed
48 Vac/dc	S33680	S29426
100/130 Vac/dc	S33681	—
220/250 Vac/dc	S33682	S29427

PowerPact™ H-, J-, and L-Frame Circuit Breakers Accessories and Auxiliaries

Motor Operator



The motor operator remotely operates the circuit breaker featuring easy and sure operation:

- All circuit breaker indications and information remain visible and accessible, including trip unit settings and circuit breaker connection
- Suitability for isolation is maintained and padlocking remains possible
- Double insulation front face

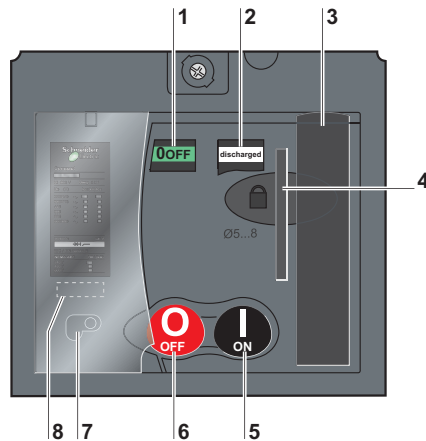

1. Contact position indicator (suitability for isolation)
2. Spring status indicator (charged, discharged)
3. Manual spring-charging handle
4. Keylock device
Locking device (off position) using one to three padlocks, diameter 0.2–0.32 in. (5–8 mm), not supplied
5. ON push button
6. OFF push button
7. Manual/auto mode selection switch; the position of the switch can be indicated remotely
8. Operation counter

Applications:

- Local motor-driven operation, centralized operation, automatic distribution control
- Normal/standby manual transfer or switching to a replacement source to optimize energy costs
- Load shedding and reconnection to optimize energy costs
- Less than five cycle closing time for source synchronization

Installation and Connection

- All installations are available for H- and J-frame circuit breakers.
All installations are available for L-frame circuit breakers except I-Line
- Connections of the motor operator module are to a built-in terminal block behind its front cover
- Stranded copper wire 14 AWG (2.5 mm²)

Automatic Operation

The motor operator is connected in series with the overcurrent trip switch (SDE).

- ON and OFF by two impulse type or continuous control signals
- Depending on the wiring, resetting can be done locally, remotely or automatically
- Mandatory manual reset following tripping due to an electrical fault (with overcurrent trip switch)

Manual Operation

- Transfer to manual mode with possibility of remote mode indication
- ON and OFF by two push buttons
- Recharging of stored-energy system by pumping the lever
- Padlocking in off position

PowerPact™ H-, J-, and L-Frame Circuit Breakers Accessories and Auxiliaries

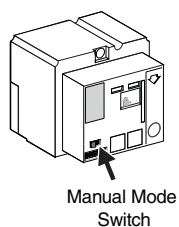

Table 92: Motor Operator Characteristics

Response Time (ms)	Opening	< 600	
	Closing	< 80	
Operating Frequency	cycles/minute max.	4	
Power Requirements ¹	AC (VA)	Opening	≤500
		Closing	≤500
	DC (W)	Opening	≤500
		Closing	≤500

¹ For H- and J-frame, the inrush current is 2x operating current for 10 ms.

Table 93: Motor Operator and Accessory Suffix Codes and Catalog Numbers

Device ¹	Control Voltage	Factory-Installed Suffix	Field-Installable Kit No.		
			H-Frame	J-Frame	L-Frame
Communicating Motor Operator	220/240 Vac 50/60 Hz	NC	S429441	S431549	S432652
Motor Operator	48/60 Vac 50/60 Hz	ML	S29440	S31548	S432639
	110/130 Vac 50/60 Hz	MA	S29433	S31540	S432640
	208/277 Vac 60 Hz	MD	S29434	S31541	S432641
	380/415 Vac 50/60 Hz	MF	—	—	S432642
	440/480 Vac 60 Hz	MH	S29435	S31542	S432647
	24/30 Vdc	MO	S29436	S31543	S432643
	48/60 Vdc	MV	S29437	S31544	S432644
	110/130 Vdc	MR	S29438	S31545	S432645
	250 Vdc	MS	S29439	S31546	S432646
Lock Mounting Hardware	—	—	—	—	S32649
Ronis® Lock	—	—	S41940	S41940	S41940
Profalux® Lock	—	—	S42888	S42888	S42888
Mounting Hardware with Ronis Lock	—	—	S429449	S429449	—
Operations Counter	—	—	—	—	S32648
Adapter for I-Line Circuit Breaker	—	—	S37420	S37420	—

¹ For NSX cord (communication suffixes EA, EB, ED, and EE) any motor operator may be selected.
For BSCM + NSX cord (communication suffixes EB, EH, EK, and EL) only the communicating motor operator may be selected.

Add-On Ground-Fault Module (GFM) (H- and J-Frame Only)

The Micrologic Ground-Fault Module (GFM) is a UL Listed/CSA Certified circuit breaker accessory which protects equipment from damage caused by ground faults. It is an add-on module which, when connected to a PowerPact H- or J-frame thermal-magnetic circuit breaker only, provides ground-fault sensing and ground-fault relay functions.

HD/JD ground-fault modules feature:

- Adjustable ground-fault pickup levels
- Adjustable ground-fault time delays
- Integral ground-fault push-to-test feature
- Ground-fault indicator (mechanical for local, contacts for remote)
- All GFMs are supplied for I-Line™ mounting as standard, easily convertible to unit mount by removing the I-Line bracket.
- Fault-powered (through the sensing current transformer) for electronics, shunt trip, and integral test feature. Meets NEC 230.95(C).
- A 12 Vdc shunt trip module (Catalog No. S29382) is required in the circuit breaker. This may be field installed or factory installed when the circuit breaker is ordered with an -SN suffix.
- UL 1053 – Ground-fault Sensing and Relaying Equipment

The GFM system requires the following:

- H-frame (15–150 A) or J-frame (150–250 A) molded case circuit breaker
- Shunt trip for circuit breaker (may be factory-installed or field-installed)
- Bus bar connection (terminal nut inserts) for OFF end of circuit breaker
- Optional neutral current transformer, catalog number GFM25CT (must be ordered for 4-wire applications).

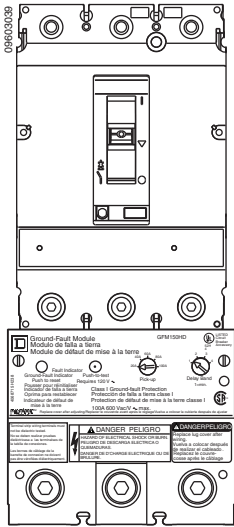

**J-Frame Circuit Breaker
with GFM Installed**

Table 94: Ground-Fault Module

Catalog No.	Rating	Sensitivity	Time Delay (Approximate)
GFM150HD	150 A	20, 40, 60, 80, 100 A	0.2, 0.3, 0.4, 0.6 sec
GFM250JD	250 A	40, 80, 120, 160, 200 A	0.2, 0.3, 0.4, 0.6 sec

Earth Leakage Module (ELM) (H- and J-Frame Only)



J-Frame Circuit Breaker
with ELM Installed

The Earth Leakage Module (ELM) is an add-on module which, when connected to a PowerPact H- or J-frame MCCB, provides low-level ground-fault sensing and ground-fault relay functions.

Because these ELMs are highly sensitive (30 mA to 3 A), they provide much greater protection than GFMs (20 Amps to 200 Amps sensitivity). The ELMs provide greater protection of control circuits and other sensitive equipment. The associated circuit breaker must have a 48 Vdc shunt trip, which may be field-installed (kit S29392) or factory-installed (suffix –SP) in the H- or J-Frame circuit breaker.

The add-on Earth Leakage Module (ELM) features:

- Adjustable ground-fault pickup levels as low as 30 mA
- Adjustable ground-fault time delays from instantaneous to 500 msec (time delay can be applied to any setting)
- Integral ground fault push-to-test feature
- Ground-fault indicator; pop-up button for local status and contacts for remote indication (to be used only with the tripping option)
- All ELMs are supplied for I-Line mounting and are easily convertible to unit-mount by removing the I-Line mounting feet
- Three poles; 240 to 600 Vac maximum: 3-phase, 3-wire (no neutral) and 1-phase, 2-wire applications
- Line-power obtained through internal bus to provide power for electronics, shunt trip, and integral test feature
- A shunt trip is required in the circuit breaker; it may be field-installed or factory-installed in the PowerPact H and J circuit breakers.
- UL 1053 – Ground-fault Sensing and Relaying Equipment

Table 95: ELM Selection Chart ¹

Companion Circuit Breaker		Enclosure Space Required I-Line Equipment	Catalog No.	Pick-Up Adjustments	Ground-Fault Time Delay Adjustments
Prefix	Size				
HD, HG, HJ, HL	15–150 A	LA	ELM150HD	30 mA 100 mA 300 mA	Instantaneous 60 ms 100 ms
JD, JG, JJ, JL	150–250 A	LA	ELM250JD	1A 3A	500 msec

¹ At 250 A, the ELM250JD can be used with standard (80%) rated circuit breakers only.

Factory-Installed ELMs

The catalog number for circuit breakers with factory-installed ELM should include the special suffixes SP and VL or VM:

H D M 3 6 150 SP VL

where

- H = H-frame (or J = J-frame)
- D = D interruption level (or G, J or L)
- M = Lugs on ON end and terminal nuts on OFF end (required)
- SP = Factory-installed 48 Vdc shunt trip (S29392, required)
- VL = Earth Leakage Module (ELM) <150 A (H-frame) or
VM = Earth Leakage Module (ELM) <250 A (J-frame)

Rotary Operating Handles

Directly Mounted Rotary Operating Handles

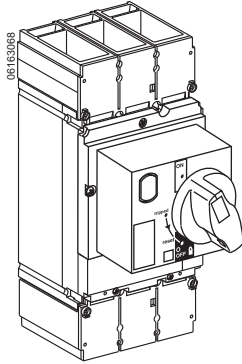

Directly Mounted Rotary Operating Handle

Installation	The directly mounted rotary operating handle replaces the circuit breaker front accessory cover (secured by screws).
Operation	<p>The direct rotary handle maintains:</p> <ul style="list-style-type: none"> Suitability for isolation Indication of three positions: I (ON), Tripped and O (OFF) Access to the “push-to-trip” button Visibility of, and access to, trip unit settings The circuit breaker may be locked in the OFF position by using one to three padlocks (not supplied)
Models	<ul style="list-style-type: none"> Standard with black handle VDE type with red handle and yellow bezel for machine tool control
Variations	<p>Accessories transform the standard direct rotary handle for the following situations:</p> <ul style="list-style-type: none"> Motor control centers (MCCs): <ul style="list-style-type: none"> Opening of door prevented when circuit breaker is on Closing of circuit breaker inhibited when door is open Machine tool control; complies with CNOMO E03.81.501N; degree of protection IP54 Early make or early break contacts may be installed into direct mount rotary handle
Standards	The directly-mounted rotary operating handle is UL Listed under file E103955 and CSA Certified under file LR 69561

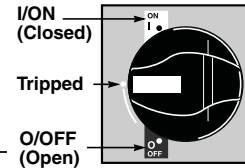

Door-Mounted (Extended) Rotary Operating Handle

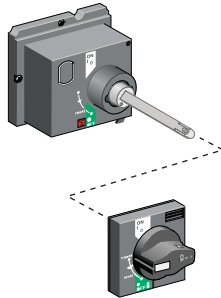

Door Mounted Rotary Operating Handle

Installation	<p>The door-mounted (extended) rotary operating handle is made up of:</p> <ul style="list-style-type: none"> A unit that replaces the front accessory cover of the circuit breaker (secured by screws) An assembly (handle and front plate) on the door that is always secured in the same position, whether the circuit breaker is installed vertically or horizontally An adjustable extension shaft The handle mechanism can be used in NEMA 3R and 12 enclosure applications
Operation	<p>The door mounted operating handle makes it possible to operate circuit breakers installed in enclosure from the front. The door mounted operating handle maintains:</p> <ul style="list-style-type: none"> Suitability for isolation Indication of the three positions OFF (O), ON (I) and tripped Visibility of and access to trip unit settings when the door is open Degree of protection: IP40 as per IEC 529 <p>Defeatable interlock prevents opening of door when circuit breaker is on</p> <p>The circuit breaker may be locked in the off position by using one to three padlocks, padlock shackle diameter 0.19–0.31 in. (5–8 mm); padlocks are not supplied; locking prevents opening of the enclosure door</p>
Shaft Length	<p>The shaft length is the distance between the back of the circuit breaker and the door:</p> <ul style="list-style-type: none"> Minimum shaft length is 7.4 (185 mm) Maximum shaft length is 24 in. (600 mm) Extended shaft length must be adjusted
Models	<ul style="list-style-type: none"> Standard with black handle VDE type with red handle and yellow bezel for machine tool control
Variations	For drawout configurations, the extended rotary handle is also available with a telescopic shaft containing two stable positions
Standards	The door-mounted rotary operating handle is UL Listed under file E103955 and CSA Certified under file LR 69561

PowerPact™ H-, J-, and L-Frame Circuit Breakers Accessories and Auxiliaries

Table 96: Rotary Operated Handles

Device		Description	H- and J-Frame		L-Frame	
			Factory Installed Suffix	Field Installable Kit No.	Factory Installed Suffix	Field Installable Kit No.
Direct Mounted	Standard Handle Black	Handle only	RD10	S29337	RD10	S32597
	Standard Black Handle with	One early-break switch	RD12	S29337 + S29345	RD12	S32597 + S32605
		Two early-make switches	RD13	S29337 + S29346	RD13	S32597 + S29346
	Red handle on yellow bezel	Handle Only	RD20	S29339	RD20	S32599
		One early-break switch	RD22	S29339 + S29345	RD22	S32599 + S32605
		Two early-make switches	RD23	S29339 + S29346	RD23	S32599 + S29346
	MCC Conversion Accessory		—	S429341	—	S32606
	CNOMO Conversion Accessory		—	S29342	—	S32602
Door Mounted	Standard black handle	Handle Only	RE10	S29338	RE10	S32598
	Standard Black Handle with:	Two early make switches	RE13	S29338 + S29345	RE13	S32598 + S32605
	Red handle on yellow bezel	Handle Only	RE20	S29340	RE20	S32600
Telescoping			RT10	S29343	RT10	S32603
Accessories	Key lock adapter		—	S429344	—	S32604
	Key locks	Ronis 1351.500	—	S41940	—	S41940
		Profalux KS5 B24 D4Z	—	S42888	—	S42888
		2 Ronis keylocks with 1 key	—	S41950	—	S41950
		2 Profalux keylocks with 1 key	—	S42878	—	S42878
	Indication Auxiliary Switch	One early-break switch	—	S29345	—	S32605
		Two early-make switches	—	S29346	—	S29346

Class 9421 NEMA Door Mounted Rotary Operating Handles



Installation	<p>The extended rotary operating handle is made up of:</p> <ul style="list-style-type: none"> • A mounting plate that provides a rotary actuator for a standard toggle circuit breaker • Handle assemblies available for NEMA 3, 3R, 4, and 4X • Available in standard or short (3 in.) handle assemblies
Operation	<p>The door mounted operating handle makes it possible to operate circuit breakers installed in enclosure from the front.</p> <p>Provides ON (I) and OFF (O) indication</p> <p>The circuit breaker may be locked in the off position</p>
Shaft Length	<p>The shaft length is the distance between the back of the circuit breaker and the door:</p> <ul style="list-style-type: none"> • Minimum mounting depth is 5.5 in. (138 mm) • Maximum mounting depth is 10.75 in. (273 mm) with standard shaft • Maximum mounting depth is 21.3 in. (543 mm) with long shaft

H- and J-Frame Class 9421 Door-Mounted Operating Mechanism

Description	Catalog No.
Standard Shaft Kit	9421LJ1
Long Shaft Kit	9421LJ4

PowerPact™ H-, J-, and L-Frame Circuit Breakers Accessories and Auxiliaries

Table 97: H- and J-Frame Component Parts

Description		Catalog No.
Standard Handle Assembly	Type 1, 3R, 12	9421LH6
	NEMA Type 3 and 4, Painted	9421LH46
	NEMA Type 3 and 4, Chrome Plated	9421LC46
Operating Mechanism	Includes Lockout	9421LJ7
Standard Shaft	Support Bracket Not Required	9421LS8
Long Shaft	Support Bracket Included	9421LS13

Table 98: L-Frame NEMA Door-Mounted Rotary Operated Handles

Handle Type	Poles	Operating Mechanism Included in Kit	Mounting Depth Min–Max	Kit Number
Painted 6 in.	3	9421LS8 and 9421LC46	7-1/4 to 12-1/16 in. (184 to 306 mm)	9421LD1
		9421LS13 and 9421LH46	7-1/4 to 22-5/8 in. (184 to 575 mm)	9421LD4

Class 9422 Cable Operating Handle

Flange-mounted handle cable operating mechanism is for use with Class 9422 Type A handle operators especially designed for tall, deep enclosures where placement flexibility is required.

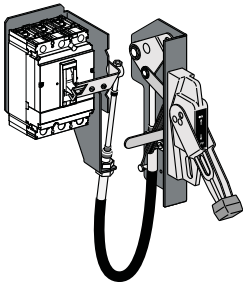

Applications	<ul style="list-style-type: none"> The cable operator maintains: <ul style="list-style-type: none"> Suitability for isolation Indication of three positions: O (OFF), I (ON) and tripped Access to push-to-test The circuit breaker may be locked in the off position by one to three padlocks Door can be locked closed due to interlocking features of the handle operator
Installation	<ul style="list-style-type: none"> Handle is mounted on flange of enclosure using specified mounting dimensions while circuit breaker and operating mechanism are mounted to inside of enclosure using two screws Cable lengths available in 3-, 5- or 10-foot lengths to accommodate a variety of mounting locations Handles are available in painted NEMA 1, 3, 3R, 4 (sheet steel) and 12 ratings or chrome (NEMA 4, 4X)

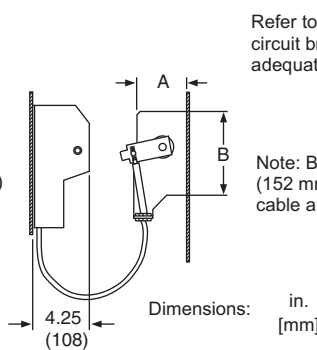
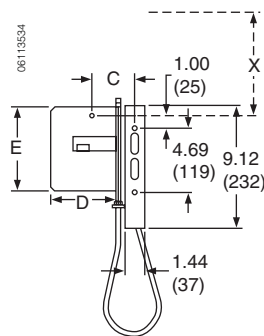

Refer to NEC Article 430-10 for minimum dimension X from circuit breaker top mounting hole to wall or barrier to ensure adequate wire bending space.

Note: Bend radius in cable must never be less than 6 in. (152 mm). Electrical clearances must be maintained between cable and live electrical parts.

Table 99: Class 9422 Cable Operating Mechanisms and A1 Handles

Description	H- and J-Frame Kit Number	L-Frame Kit Number
Cable Mechanism Length	36 in. (914 mm)	9422CSF30
	60 in. (1524 mm)	9422CSF50
	84 in. (2134 mm)	9422CSF70
	120 in. (3048 mm)	9422CSF10
A1 painted flange handle	—	9422A1
Operating Mechanism Only	—	9422RSI

Class 9422 Flange-Mounted Variable-Depth Operating Mechanism

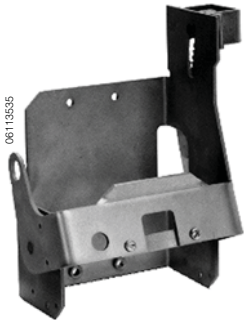

Threaded-rod flange-mounted variable depth operating mechanism

Designed for installation in custom built control enclosures where main or branch circuit protective devices are required.

- All circuit breaker operating mechanisms are suitable for either right- or left-hand flange mounting, convertible on the job.
- H- and J-frame variable mounting depth range: 5.88–17.75 in. (149–451 mm).
- H- and J-frame operating mechanism 9422RQ1 does not include handle mechanism.

Designed for installation in custom-built control enclosures where main or branch circuit protective devices are required. All circuit breaker operating mechanisms are suitable for either right- or left-hand flange mounting, convertible in the field.

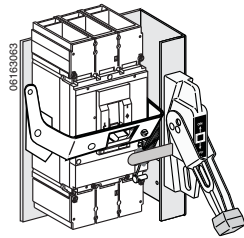

Table 100: L-Frame Flange-Mounted Operating Mechanism

Description	Depth	Kit Number
Variable Depth Mechanism	9.00–17.75 in. (229–451 mm)	9422RSI

Locking Systems

Padlocking systems can receive up to three padlocks with diameters of 0.19–0.31 in. (5–8 mm); padlocks not supplied.

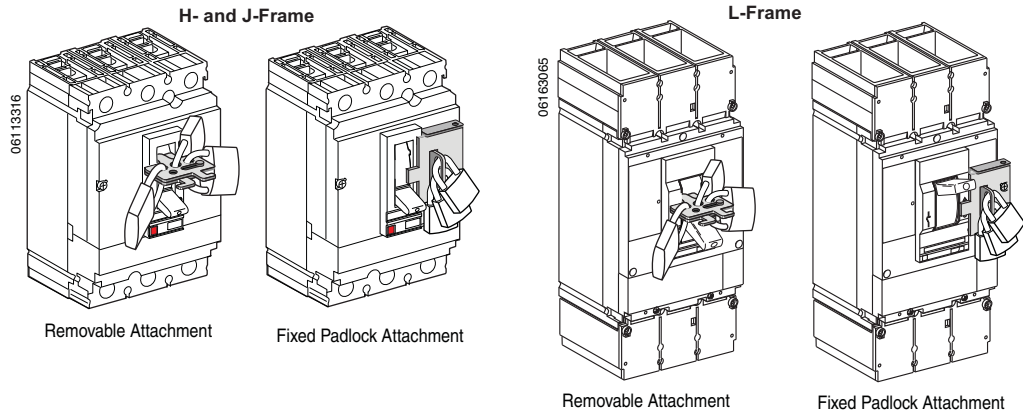

Table 101: Device Locking, Interlocking Options

Device	Description	Field-Installed Cat. No.	
		H- and J-Frame	L-Frame
Handle Padlocking Device ¹	Removable (lock OFF only)	S29370	S29370
	Fixed (lock OFF or ON)	S29371	S32631
	Fixed (lock OFF only) ²	S37422	NJPAF
Key Locking	Provision and 2 locks keyed alike	Ronis	S41950
		Profalux	S42878

¹ Rotary handles and motor operators have integral padlocking capability.

² Not available in HD or HG 2P modules.

Manual Mechanical Interlocking Systems

Some installations use two power supply sources to counter any temporary loss in the main supply. A mechanical interlocking system is required to safely switch between the two sources. The replacement source can be a generator set or another network.

Managing multiple power sources can be controlled manually by mechanical interlocks.

The mechanical interlocking system is made up of:

- two H-, J-, or L-frame devices (circuit breakers or switches) controlled manually
- mechanical interlocking, which prevents handle movement from the OFF position while the other device is in the ON position.

Since it is controlled manually by a maintenance technician, switchover time from the normal source to the replacement source can vary.

Figure 4: Interlocking Systems

H- and J-Frame

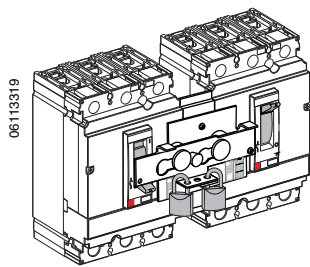

Interlocking with Toggle Control (S29354)

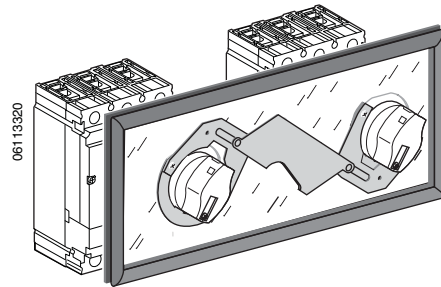

Interlocking with Rotary Handles (S29369)

L-Frame

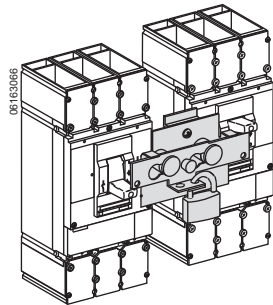

Interlocking with Toggle Control (S32614)

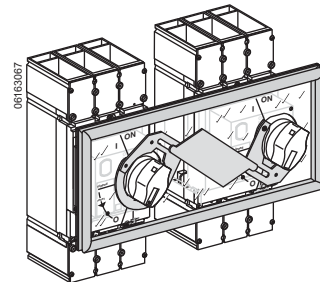

Interlocking with Rotary Handles (S32621)

Interlocking of Circuit Breakers With Toggle Control

Two devices can be interlocked using this system. Two identical interlocking systems can be used to interlock three devices installed side by side.

Authorized positions:

- one device closed (ON), the others open (OFF)
- all devices open (OFF)

The system is locked using one or two padlocks (shackle diameter 0.19–0.31 in. [5 to 8 mm]). This system can be expanded to more than three devices.

There are two interlocking-system models:

- one for PowerPact H- and J-frame circuit breakers
- one for PowerPact L-frame circuit breakers

All toggle-controlled unit-mount or plug-in PowerPact H-, J-, and L-frame circuit breakers and automatic switches of the same frame size can be interlocked. The devices must be either all unit-mount or all plug-in versions. Interlocking is not available for I-Line constructions.

The toggle interlock system can receive one or two padlocks with diameters of 0.19–0.31 in. (5–8 mm). Both interlocked circuit breakers must be unit-mount or both plug-in. Two sliding interlocking bars can be used to interlock three circuit breakers installed side-by-side, in which case one circuit breaker is in the ON (I) position and the two others in the OFF (O) position. (Kit S29354. Not available for 2P HD and HG devices.)

Interlocking of Two Devices with Rotary Handles

Interlocking involves padlocking the rotary handles on two devices which may be either circuit breakers or automatic switches.

Authorized positions:

- one device closed (ON), the other open (OFF)
- both devices open (OFF).

The system is locked using up to three padlocks (shackle diameter 0.19–0.31 in. [5 to 8 mm]).

There are two interlocking-system models:

- one for PowerPact H- and J-frame circuit breakers
- one for PowerPact L-frame circuit breakers

All rotary-handle unit-mount or plug-in PowerPact H-, J-, and L-frame circuit breakers and automatic switches of the same frame size can be interlocked. The devices must be either all unit-mount or all plug-in versions. Interlocking is not available for I-Line constructions

The rotary handles are padlocked with the devices in the OFF (I) position. The interlock mechanism inhibits the two devices from being closed (ON/I) at the same time, but allows for both devices to be open (OFF/O) simultaneously. (Kit S29369. Not available for 2P HD and HG devices.)

Table 102: Interlocking Accessories

Accessory	Means	Kit Number	
		H-, J-Frame	L-Frame
Interlocking (UL listed)	Mechanical for circuit breakers with rotary handles ¹	S29369	S32621
	Mechanical for circuit breakers with toggles ¹	S29354	S32614

¹ Not available in HD or HG 2P modules.

PowerPact™ H-, J-, and L-Frame Circuit Breakers Accessories and Auxiliaries

Interlocking Devices using Keylocks (Captive Keys)

Interlocking using keylocks makes it possible to interlock two or more devices that are physically distant or that have very different characteristics, for example medium-voltage and low-voltage devices or a PowerPact H-, J-, and L-frame circuit breaker and automatic switch.

Each device is equipped with an identical keylock and the key is captive on the closed (ON) device. A single key is available for all devices. It is necessary to first open (OFF position) the device with the key before the key can be withdrawn and used to close another device.

All rotary-handle PowerPact H-, J-, and L-frame circuit breakers and automatic switches can be interlocked between each other or with any other device equipped with the same type of keylock.

For circuit breakers equipped with rotary handles or a motor operator. Interlocking with keys may be easily implemented by equipping each of the circuit breakers, either unit-mount or drawout, with a directly mounted rotary operating handle and a standard keylock, with only one key for the two keylocks. This solution enables interlocking between two circuit breakers that are geographically distant or that have significantly different characteristics.

Use:

- A keylock adapter (one required for each circuit breaker)
- Two identical keylocks with a single key

See Table 96 for more information.

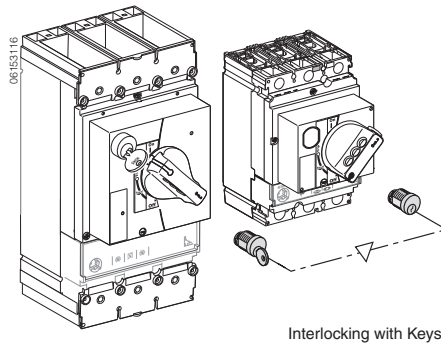

Sealing Accessory

The sealing accessory kits includes the elements required to fit seals to prevent:

- Front accessory cover removal
- Rotary handle removal
- Opening of the motor operator
- Access to accessories
- Access to trip unit settings
- Access to ground-fault protection settings
- Trip unit removal
- Terminal cover removal
- Access to power connections

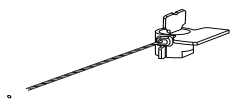

Table 103: Sealing Accessory Kits

Description	Kit No.	Qty.
Trip Unit Sealing Accessory Kit	MICROTUSEAL	6
Front Cover Screws Sealing Accessory Kit	S29375	6

Front-Panel Escutcheons

- For unit-mount or plug-in installation.
- Front-panel escutcheons for toggle handles secures to the panel from the front.
- Front-panel escutcheons for motor-operated or rotary-operating handle secures to the panel by four screws from the front.

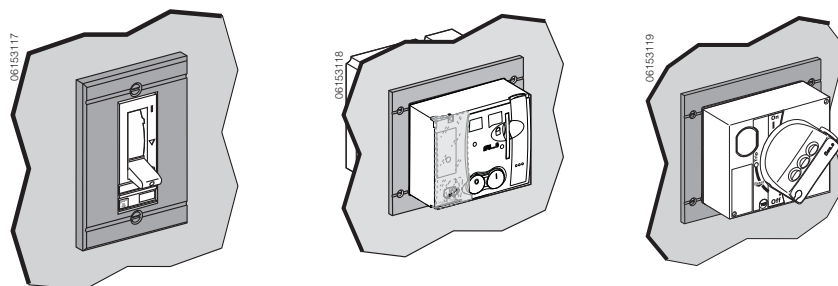

Table 104: Front-Panel Escutcheons

Description	Kit Number	
	H-, J-Frame	L-Frame
Front Panel Escutcheon for Toggle Circuit Breakers	S29315	32556
Front Panel Escutcheon for Rotary Handle, Motor Operator or Extended Escutcheon	S29317	S32558

Toggle Collars (For Drawout Mounting)

Toggle collars make it possible to maintain degrees of protection regardless of the circuit breaker position (connected, disconnected):

- Front panel escutcheons are required (identical to those for rotary handle and ammeter module)
- Toggle collars are secured by two screws on the circuit breaker
- Front panel escutcheons are secured on the enclosure
- Toggle extension is supplied with the toggle collar

Front panel escutcheons for motor operator and rotary operating handles are the same as for the unit-mount circuit breakers.

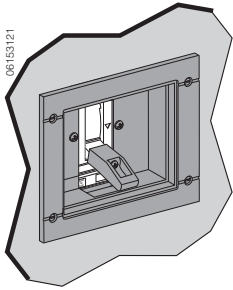

Table 105: Toggle Collars

Description	H-, J-Frame Kit Number	L-Frame Kit Number
Toggle Collar	S29284	S32534

Toggle Boot

- NEMA 1, 2, 3, 3R protection
- Fits on front of circuit breaker

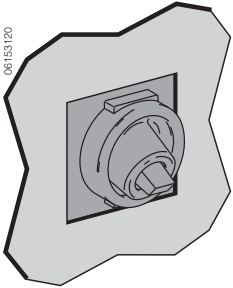

Table 106: Toggle Boot

Description	Kit Number	
	H-, J-Frame ¹	L-Frame
Toggle Boot	S29319	S32560

¹ Not available for HD and HG 2P modules

Handle Extension

Designed to extend the circuit breaker handle for easier manual circuit breaker operation.

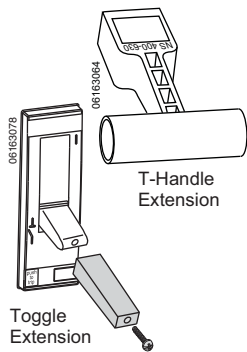

Table 107: Handle Extensions

Description	Qty.	Kit Number	
		H-, J-Frame	L-Frame
T-Handle Extension (Temporary)	1	—	32595
Toggle Extension (Fixed)	5	S29313	S432553

Circuit Breaker Enclosures and Enclosure Accessories

- Square D™ brand circuit breaker enclosures are UL Listed/CSA Certified and are suitable for use as service entrance equipment, except as footnoted.
- The short circuit rating of an enclosed circuit breaker is equal to the rating of the circuit breaker installed, except as footnoted.
- Circuit breakers are ordered and shipped separately for field installation.

Table 108: Enclosure Dimensions

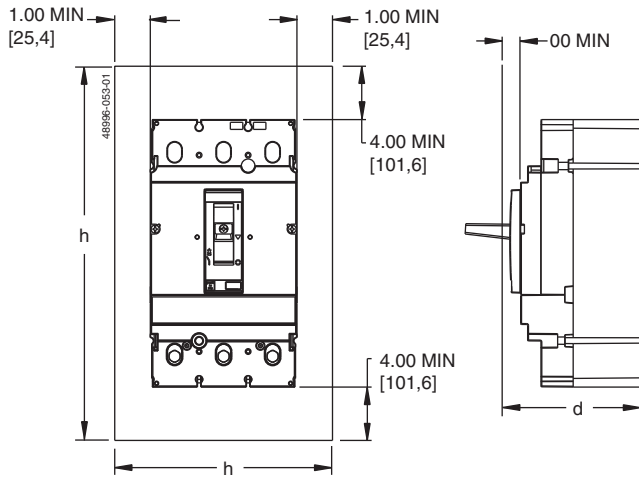

Circuit Breaker	Amperage	Enclosure Dimensions (h x w x d)	
		Standard (80%)	100% Rated
H-Frame	15–150 A	18.13 x 8.63 x 4.13 in. (461 x 219 x 105 mm)	62 x 14 x 22.5 in. (1575 x 356 x 572 mm)
J-Frame	150–250 A	28.5 x 12.38 x 5.38 in. (724 x 314 x 137 mm)	62 x 14 x 22.5 in. (1575 x 356 x 572 mm)
L-Frame	250–600 A	40.5 x 13.75 x 4.33 in. (1030 x 350 x 110 mm)	40.5 x 13.75 x 4.33 in. (1030 x 350 x 110 mm)

Table 109: Circuit Breaker Enclosure Catalog Numbers

Circuit Breaker			Enclosure Cat. No.				
Cat. No. Prefix	Rating	Poles	NEMA 1 Flush	NEMA 1 Surface	NEMA 3R ¹	NEMA 4, 4X, 5, 3, 3R Stainless Steel	NEMA 12/3R, 5 (Without Knockouts) ²
HDL,HGL,HJL,HLL	15–150 A	2, 3	J250F	J250S	J250R	J250DS	J250AWK
JDL,JGL,JJL,JLL	150–250 A	2, 3					
HDL	15–100 A	3	—	HD100S ^{3, 4, 5}	—	—	—
JDL	150–250 A	3	—	JD250S ^{3, 5, 6}	—	—	—

¹ Enclosures with NRB or RB suffix have provisions for 3/4 in. through 2-1/2 in. bolt-on hubs in top endwall. Enclosures with R suffix have blank endwalls and require field cut opening.

² Suitable for rainproof NEMA 3R application by removing drain screw from bottom endwall.

³ Copper wire only.

⁴ Maximum short circuit current rating is 25 kA, 240 Vac

⁵ Order service ground kit PKOGTA2 if required.

⁶ Maximum short circuit current rating is 18 kA, 480 Vac.

Table 110: Dimensions

Cat. No.	Approximate Dimension						
	Series	H		W		D	
HD100S	A01	17.00 in.	431.8 mm	7.90 in.	200.7 mm	4.75 in.	120.7 mm
J250F	A01	32.40 in.	823 mm	15.40 in.	391 mm	6.00 in.	152 mm
J250S	A01	31.36 in.	797 mm	14.36 in.	365 mm	6.00 in.	152 mm
J250R	A01	31.05 in.	789 mm	14.47 in.	368 mm	6.28 in.	160 mm
J250DS	A01	32.26 in.	819 mm	9.72 in.	247 mm	7.94 in.	202 mm
J250AWK	A01	32.26 in.	819 mm	9.72 in.	247 mm	7.94 in.	202 mm

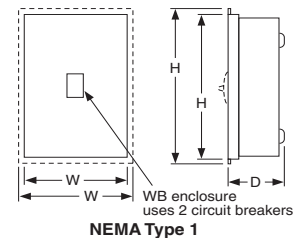

PowerPact™ H-, J-, and L-Frame Circuit Breakers Accessories and Auxiliaries

Table 111: Insulated Grounded Neutral Assembly

Circuit Breaker		Neutral Assembly For Use With		Terminal Lug Data—Total Available (Line plus Load) AWG/kcmil
Cat. No. Prefix	Ampere Rating	NEMA 1 & 3R	NEMA 4, 4X, 5, 12 & 12K	
		Cat. No.	Cat. No.	
HDL,HGL,HJL,HLL	15–100 A	SN100FA	SN100FA	(4) 14–1/0 Cu or (4) 12–1/0 Al
HDL,HGL,HJL,HLL	125–150 A	SN400LA	SN400LA	(2) 1–600 or (4) 1–250 Al/Cu, plus (2) 4–300 Al/Cu
JDL,JGL,JJL,JLL	150–250 A	SN400LA	SN400LA	(2) 1–600 or (4) 1–250 Al/Cu, plus (2) 4–300 Al/Cu

Table 112: Service Ground Kits

Circuit Breaker Cat. No. Prefix	Ground Bar Cat. No.	Number of Terminals	Conductors Per Terminal	Wire Range
HDL,HGL,HJL,HLL, JDL,JGL,JJL,JLL	PKOGTJ250	2	1	6 AWG–300 kcmil Al/Cu

Section 9—Circuit Breaker Mounting and Connections

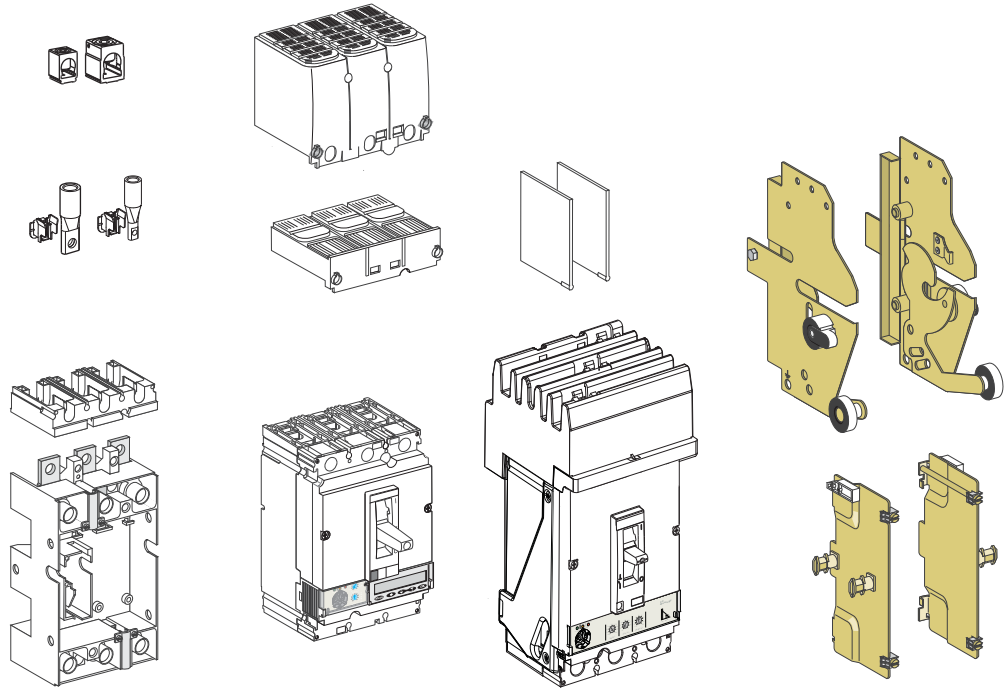

Mounting Configurations

The PowerPact™ H-, J-, and L-frame circuit breakers are available in a variety of configurations.

Table 113: Mounting Options

Termination Letter	Poles		Options Code Suffix
	H-, J-Frame	L-Frame	
A = I-Line	3 Pole Only	3 Pole Only	For factory-installed terminations, place termination letter in the third block of the circuit breaker catalog number. L ₁ G ₁ D ₁ 3 ₁ 6 ₁ 4 ₁ 0 ₁ U ₁ 3 ₁ 1 ₁ X ₁ H ₁ J ₁ 0 ₁ 0 ₁ Termination No. Options Code
F = Bus Bar	3 Pole Only	3 or 4 Pole	
L = Lugs on Both Ends	3 Pole Only	3 or 4 Pole	
M = Lugs ON End	3 Pole Only	3 or 4 Pole	
P = Lugs OFF End	3 Pole Only	3 or 4 Pole	
N = Plug-In	3 Pole Only	3 or 4 Pole	
D = Drawout	3 Pole Only	3 or 4 Pole	
S = Rear Connection	3 Pole Only	3 or 4 Pole	

Refer to circuit breaker installation bulletin before installing circuit breaker, accessories, or wiring.

PowerPact™ H-, J-, and L-Frame Circuit Breakers

Circuit Breaker Mounting and Connections

Unit-Mount Circuit Breakers

The standard lugs can be removed for the installation of compression-type lugs or bus connections. All lugs are UL Listed/CSA Certified for their proper application and marked for use with aluminum and copper (Al/Cu) or copper only (Cu) conductors. Lugs suitable for copper and aluminum conductors are made of tin-plated aluminum.

Mounting

H-, J-, and L-frame circuit breakers may be mounted vertically, horizontally or flat on their back without any derating of characteristics.

Unit-mount H- and J-frame circuit breakers are supplied with two mounting screws, unit-mount L-frame circuit breakers are supplied with four mounting screws. These mounting screws are inserted through mounting holes molded into the circuit breaker case and threaded into the mounting enclosure, rails or through the panel door for flush mounting.

A DIN rail mounting bracket (catalog no. S29305) is available for the H- and J-frame circuit breakers.

NOTE: DIN rail mounting is not compatible with motor operated applications.

Figure 5: Unit-Mounting Options

H-, J-Frame Circuit Breakers (2 Mounting Screws)

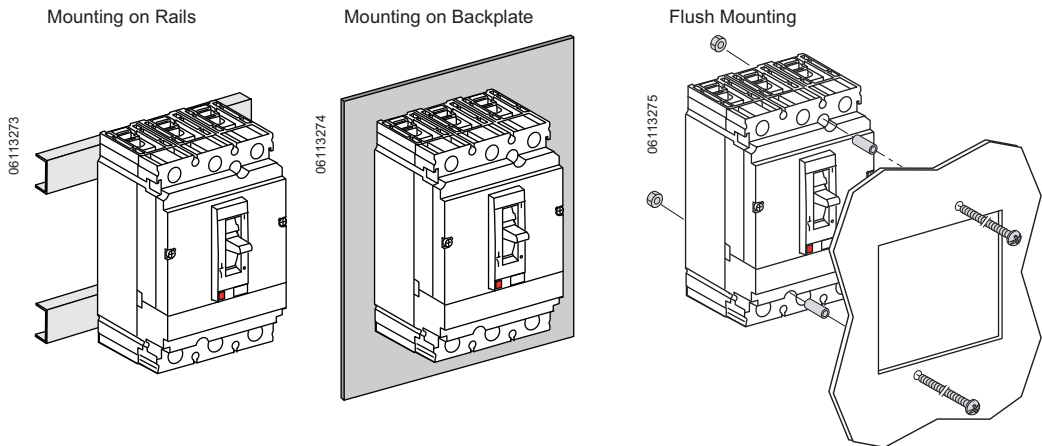

L-Frame Circuit Breakers (4 Mounting Screws)

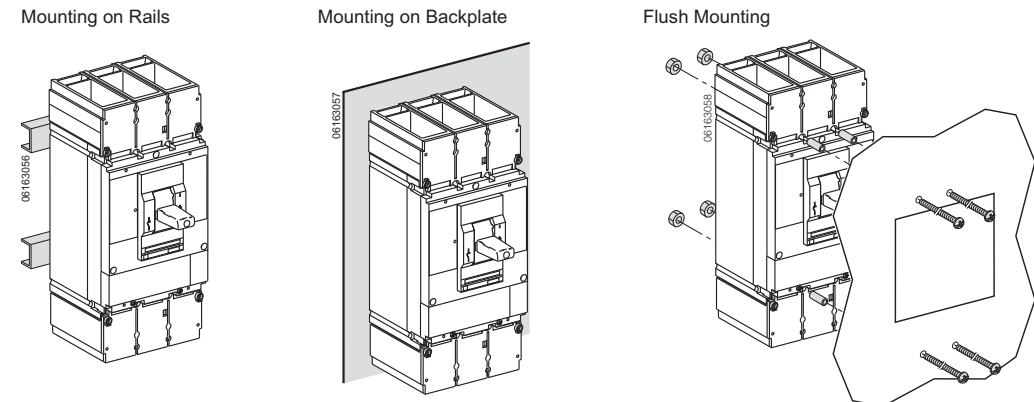

PowerPact™ H-, J-, and L-Frame Circuit Breakers Circuit Breaker Mounting and Connections

I-Line™ Circuit breakers

PowerPact H-, J-, and L-frame circuit breakers are available in I-Line construction for easy installation and removal in I-Line applications.

I-Line circuit breakers use “blow-on” type line side connectors. In case of a short circuit, increased magnetic flux causes the plug-on connectors of the circuit breaker to tighten their grasp on the bus bars. The I-Line connectors and circuit breaker mounting bracket are integral parts of I-Line circuit breakers and cannot be removed or replaced. I-Line circuit breakers come with mechanical load side lugs, or optional terminal nut to connect to bus bars or to compression (crimp) lugs.

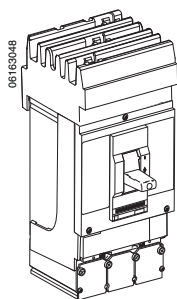
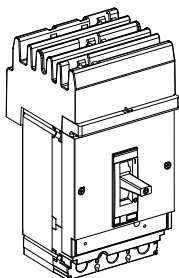

Table 114: Phase Options—Example HDA36150

Phase Option Number	Phase Connection	2P Example	3P Example
1	AB	HDA261501	—
2	AC	HDA261502	—
3	BA	HDA261503	—
4	BC	HDA261504	—
5	CA	HDA261505	—
6	CB	HDA261506	—
Standard	ABC	—	HDA36150
6	CBA	—	HDA361506

Plug-In Circuit Breaker Mounting

The plug-in base is mounted through a panel. The plug-in configuration makes it possible to:

- Extract and/or rapidly replace the circuit breaker without having to touch connections
- Allow for addition of future circuits at a later date

When the circuit breaker is in the connected position, the primary voltage is fed through the circuit breaker by means of multiple finger disconnects. Control voltage of internal accessories is provided through secondary disconnects.

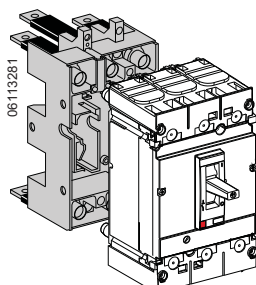

Plug-In Mounting

Parts of a Plug-In Configuration

- Plug-in Base: The plug-in base provides mounting through a front panel or mounting on rails.
- Disconnects: Provides both primary and secondary disconnect to the circuit breaker.
- Safety Trip Interlock: The safety trip causes automatic tripping if the circuit breaker is ON before engaging or withdrawing it; the safety trip does not prevent the circuit breaker operation, even when the circuit breaker is disconnected.
- Plug-in Base: The plug-in base provides mounting through a front panel or mounting on rails.
- Mandatory short terminal shields.

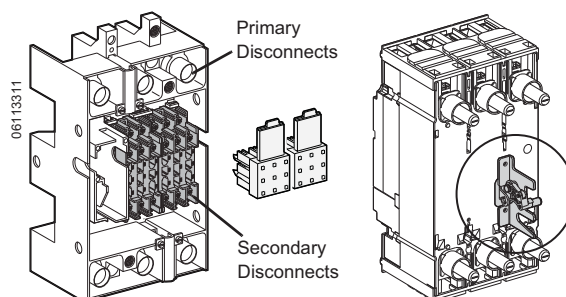

Safety Trip Interlock Mounted on Back of Circuit Breaker

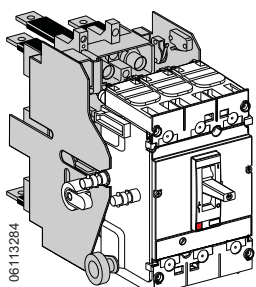

Drawout Mounting

PowerPact™ H-, J-, and L-Frame Circuit Breakers

Circuit Breaker Mounting and Connections

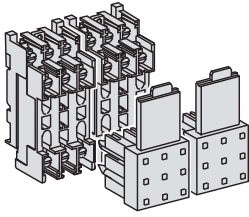

Disconnecting Blocks

Accessory circuits exit the circuit breaker using one to three secondary disconnecting blocks (nine wires each). Circuit breaker connection wires for the options installed with trip unit STR53UP exit through the automatic secondary disconnecting blocks. These are made up of:

- A moving part connected to the circuit breaker through a support (one support per circuit breaker).
- A fixed part mounted on the plug-in base, equipped with connectors for wire up to 14 AWG (2.5 mm²).

For test purposes, circuit breakers may be equipped with one to three manual auxiliary connectors, which allow the auxiliaries to remain connected when in the “disconnected” position.

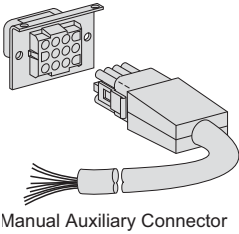

Manual Auxiliary Connector

Figure 6: Plug-In Base (Mounting Options)

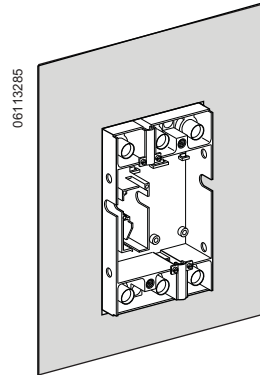

Mounting Through a Panel

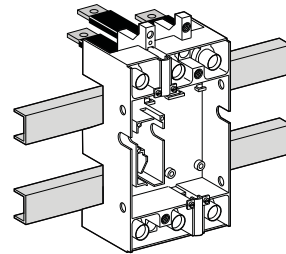

Mounting on Rails

The L-frame plug-in mounting is Listed under UL file E113555 and Certified under CSA file LR 69561.

PowerPact™ H-, J-, and L-Frame Circuit Breakers Circuit Breaker Mounting and Connections

Drawout Mounting

The cradle is made up of two side plates installed on the plug-in base and two other plates mounted on the circuit breaker.

The drawout mounting provides all of the functions of the plug-in base, plus:

- Disconnected position—the power circuit is disconnected, the circuit breaker is simply withdrawn and may still be operated (on, off, push-to-trip)
- Circuit breaker may be locked using 1 to 3 padlocks, diameter 0.19 to 0.31 inch (5–8 mm), to prevent connection
- Auxiliaries can be tested using manual auxiliary connector

Drawout mounting is on a backplate:

- Through a front panel or on rails
- Horizontally or vertically

Accessories for drawout circuit breakers:

- *Auxiliary indicator contacts indicator contacts* for installation on the fixed part of the cradle, indicating the “connected” and “disconnected” position
- *Toggle collar* for circuit breakers with toggle through front panel, intended to maintain the degree of protection whatever the position of the circuit breakers (supplied with a toggle extension)
- *Keylock* which can be used to
 - Prevent insertion for connection
 - Lock the circuit breaker in the connected or disconnected position
- *Telescopic shaft* for extended rotary handles
- *Control voltage*, which is provided through automatic secondary disconnect in the connected position only. Electrical accessories can be tested in the disconnected position with an external wiring harness.

The drawout-mounted cradle is listed under UL file E113555 and certified under CSA file LR69561.

Figure 7: Drawout Mounting Positions

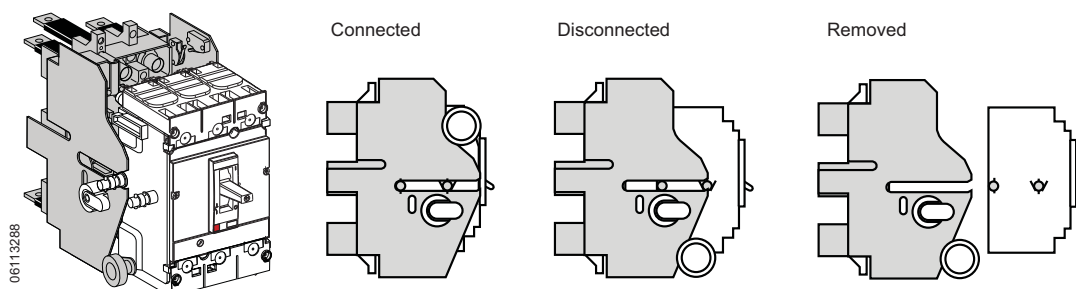

PowerPact™ H-, J-, and L-Frame Circuit Breakers

Circuit Breaker Mounting and Connections

Table 115: Plug-In and Drawout Mountings for H- and J-Frame Circuit Breakers (3P or 2P in a 3P module)

Description		Factory Installed Suffix	Field-Installed Cat. No.	
Complete Factory-Assembled Circuit Breakers	Plug-in base shipped with circuit breaker	N	—	
	Drawout cradle shipped with circuit breaker	D	—	
Special Order Options for Plug-In and Drawout Circuit Breakers	Plug-In Base	Circuit breaker Only	HJ00	
		Plug-in base kit	S29278	
	Drawout Cradle	Circuit breaker only	HJ00	
		Plug-in base kit		S29278
		Cradle side plates (fixed part of chassis)		S29282
	Circuit breaker side plates (moving part of chassis)		S29283	
Accessories for Plug-In and Drawout	H-Frame Shutter Kit (set of two)		S37442	
	J-Frame Shutter Kit (set of two)		S37443	
	Secondary Disconnect Blocks	Fixed part 9-wire connector (mounted on base)		S29273
		Moving part 9-wire connector (mounted on circuit breaker)		S29274
		Support for 2-moving connectors		S29275
	Extended escutcheon with extended toggle collar			S29284
	Two position indicating switches (connected/disconnected)			S29287
Short Terminal Covers			29321	

Table 116: Plug-In and Drawout Mountings for L-Frame Circuit Breakers

Description	Poles	Plug-in Mounting		Drawout Mounting			
		Factory Installed Suffix	Field-Installed		Factory Installed Suffix	Field-Installed	
			Qty	Kit. No.		Qty	Kit. No.
Kit (stationary and moving parts)	3	N	—		D	—	
	4	N	—		D	—	
Stationary Part	3 4		S32514			S32514	
			S32515			S32515	
						S32532	
Moving Part		HJ00			HJ00		
						S32533	
	3 4		2x ¹ S32562 2x ¹ S32563			2x ¹ S32562 2x ¹ S32563	

¹ Order two of kit.

Table 117: Plug-In and Drawout Accessories

Handle Escutcheon

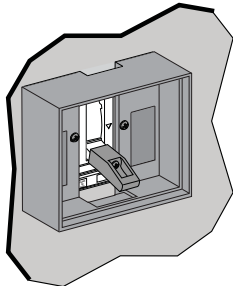

Plug-In and Drawout Accessories			Field-Installed Kit No.	
			H-, J-Frame	L-Frame
Secondary Disconnecting Blocks ¹	Fixed Part	9-Wire Connector	S29273	S29273
	Moving Part	9-Wire Connector	S29274	S32523
		Support for Moving Connectors	2x ² S29275	3x ³ S32525
Manual Auxiliary Connector	9-Wire Connector for Disconnected Operation		—	S29272
Shutter	Two Shutters for Plug-In Base		29271	32521
Classic Accessories	Extended Escutcheon for Toggle Collar		S29284	S32534
	Locking Device (Key Lock is Not Included)		S29286	S29286
	Two Position Indicator Contacts (Connected/Disconnected)		S29287	S29287

¹ Included when electrical accessories are factory installed.

² Order two of kit.

³ Order three of kit.

PowerPact™ H-, J-, and L-Frame Circuit Breakers Circuit Breaker Mounting and Connections

Connection

Rear Connection

For connection of bus bars or cables with compression lugs. Rear connections are easily installed on the circuit breaker terminals. The same connection may be installed flat, edgewise or at a 45° angle. All combinations are possible. The circuit breaker is mounted on a backplate.

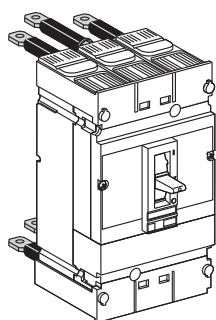

One Long and Two Short

Four Positions Possible for Each Connector

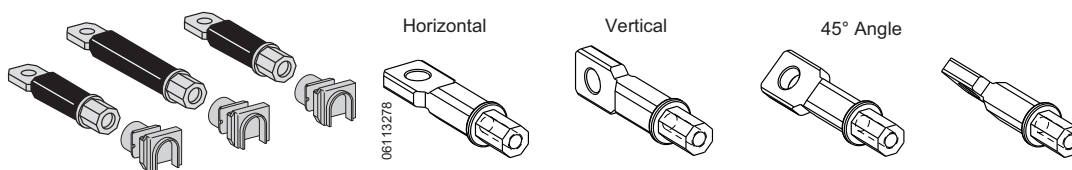

Table 118: Rear Connections

Device	Description	H-Frame			J-Frame			L-Frame		
		Poles	Factory-Installed Termination No.	Field-Installable Cat. No.	Poles	Factory-Installed Termination No.	Field-Installed Cat. No.	Poles	Factory-Installed Termination No.	Field-Installed Cat. No.
Mixed Rear Connection Kit ¹		2	S	—	2	S	—	3	S	S32477
		3	S	S37432	3	S	S37437	4	S	S32478
Consisting of:	Short rear connections (set of 2)	2 or 3	—	2x ² S37433	2 or 3	—	2x ² S37438	3	—	2x ^{2,3} S432475
	Long rear connections (set of 2)		—	S37434		—	S37439 ⁴		—	2x ³ S432476
	Short terminal cover (3P)	3	—	S37436	3	—	S37440	3	—	2x ⁵ S32562
	Short terminal cover (4P)	4	—	—	—	—	—	4	—	2x ⁵ S32563

¹ Kit contains four short rear connections, two long rear connections (four long rear connections for 4P), hardware and two terminal covers.

² Order two kits (two in kit x two kits for total of four).

³ Parts only, no hardware is included. See Table 119, below.

⁴ For use with 3P circuit breakers only.

⁵ Order two kits (kit contains only one terminal cover, two terminal covers are required per circuit breaker).

Table 119: L-Frame Rear Connection Hardware

Description	Cat. No.
Set of 4 M10 x 25 terminal screws and washers for one side.	S36967

Mechanical Lugs

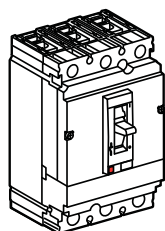

Unit-mount H-, J-, and L-frame circuit breakers can be ordered with mechanical line and load side lugs. The standard lugs can be removed for the installation of compression-type lugs or bus connections. All lugs are UL Listed/CSA Certified for their proper application and marked for use with aluminum and copper (Al/Cu) or copper only (Cu) conductors. Lugs suitable for copper and aluminum conductors are made of tin-plated aluminum. Lugs suitable for use with copper conductors only are made of copper.

Mechanical Lugs for the H- and J-frame circuit breakers lay on top of the circuit breaker terminals and can be installed without the use of any tools. The lugs are held in place with snap features built into the insulating retainer and are secured with the clamp force applied to the wire binding screw.

Mechanical lugs are sold either factory installed or as field installable kits.

PowerPact™ H-, J-, and L-Frame Circuit Breakers

Circuit Breaker Mounting and Connections

Table 120: Mechanical Lug Kits for H-Frame and J-Frame Circuit Breakers

	Circuit Breaker Application				Number of Wires Per Lug and Wire Range	Kit Cat. No.	Qty Per Kit
	Standard	Ampere Rating	Optional	Ampere Rating			
Al Lugs for Use with Al or Cu Wire	HD, HG, HJ, HL	15–150 A			(1) 14–3/0 AWG Al or Cu	AL150HD	3
	JD, JG, JJ, JL	150–175 A			(1) 4–4/0 AWG Al or Cu	AL175JD	3
	JD, JG, JJ, JL	200–250 A	JD,JG,JJ,JL	150–175 A	(1) 3/0–350 kcmil Al or Cu	AL250JD	3
Cu Lugs for Use with Cu Wire Only			HD,HG,HJ,HL	15–150 A	(1) 14–2/0 AWG Cu	CU150HD	3
			JD,JG,JJ,JL	150–250 A	(1) 1/0–300 kcmil Cu	CU250JD	3
Control Wire Terminal for H-frame lug kit						S37423	2
Control Wire Terminal for J-frame lug kit						S37424	2

Table 121: Mechanical Lug Kits for L-Frame Circuit Breakers¹

	Circuit Breaker Application				Number of Wires Per Lug and Wire Range ²	Kit Cat. No.	Qty Per Kit	Type of Terminal Shield ³
	Ampere Rating	Poles	Unit Mount	I-Line				
Al Lugs for Use with Al or Cu Wire	250	3	X	X	(1) 2 AWG–500 kcmil Al	AL400L61K3	3	Short
		4	X	—	(1) 2 AWG–600 kcmil Cu	AL400L61K4	4	Short
	400/600	3	X	—	(2) 2/0 AWG–500 kcmil Al or Cu	AL600LS52K3	3	Medium
		4	X	—		AL600LS52K4	4	Medium
Cu Lugs for Use with Cu Wire Only	250/400	3	X	X	(1) 2 AWG–500 kcmil Al	CU400L61K3	3	Short
		4	X	—	(1) 2 AWG–600 kcmil Cu	CU400L61K4	4	Short
	400/600	3	X	—	(1) 2/0 AWG–500 kcmil Al or Cu	CU600LS52K3	3	Medium
		4	X	—		CU600LS52K4	4	Medium
	400/600	3	X	X	(1) 3/0 AWG–500 kcmil Al or Cu	CU600LF52K3	3	Short

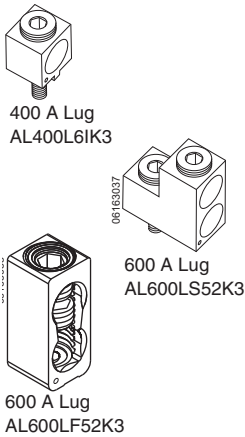

- ¹ For lug pack information, see Figure 31 on page 161.
- ² For control wire installation, use an 8-32 x 1/4 in. screw (not provided) into tapped control wire hole in lower left hand corner of lug.
- ³ For terminal shield dimensions, see Figure 31 on page 161.

Voltage Takeoff (Control Wire Terminals) for Mechanical Lugs and Terminal Nuts

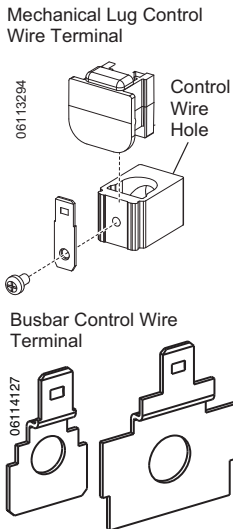

Powerpact H- and J-Frame mechanical lugs may be equipped with a separate control wire termination. The kit is available factory installed or as a field installable kit. The adaptor is secured underneath the lug and has a tab extension suitable for attachment of a 0.250 inch slip-on connector.

All L-frame mechanical lugs are pre-tapped for control wires. For control wire installation, use an 8-32 x 1/4 in. screw (not provided) into tapped control wire hole in lower left hand corner of the lug.

Fully insulated type connectors must be used to prevent live parts from extending into the wiring gutter area.

Table 122: Control Wire Terminals

Description	Frame	Cat. No.	Qty Per Kit
Mechanical Lugs			
Control Wire Terminal for H-Frame Lugs	HD/HG/HJ/HL	S37423	2
Control Wire Terminal for J-Frame Lugs	JD/JG/JJ/JL	S37424	2
Busbar Connection			
Control Wire Terminal for H-Frame Terminal Nut	HD/HG/HJ/HL	S37429	2
Control Wire Terminal for J-Frame Terminal Nut	JD/JG/JJ/JL	S37430	2
Control Tap takeoff	L-Frame	29348	2

PowerPact™ H-, J-, and L-Frame Circuit Breakers Circuit Breaker Mounting and Connections

Bus-Bar Connections

The H-, J- and L-frame circuit breakers may be equipped with captive nuts and screws for direct connection to bars or to compression (crimp) lugs

For H- and J-frame, these are readily field-installable, simply by removing the mechanical lug and replacing with the appropriate terminal nut inset described in Table 123. They are also available factory-installed, using the Product Selector or by using the catalog suffixes below.

For L-frame, the mechanical lug can be removed, leaving the threaded nut insert intact. This configuration may be ordered with the suffixes described below. Connection hardware (terminal screws) must be ordered as in table 123.

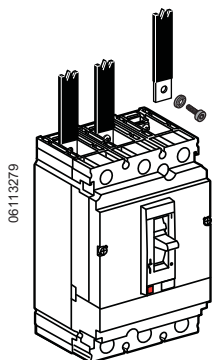

Table 123: Factory-Installed Terminal Nut Inserts for Bus or Crimp Lug Connection

Cat. No. Termination (Position 4)	Special Terminations Options	Description
F		Terminal nut insert on both ends; no lugs either end
M		Terminal nut insert on OFF end; lugs on ON end only
P		Terminal nut insert on ON end; lugs on OFF end only
A	-TA	I-Line on ON end; English terminal nuts on OFF end ¹
A	-TB	I-Line on ON end; Metric terminal nuts on OFF end ¹
F, M, or P	-TW	For -F-, Metric terminal nuts on both ends ¹
F, M, or P	-TX	For -M-, lugs on ON end; Metric terminal nuts on OFF end For -P-, Metric terminal nuts on ON end; lugs on OFF end

¹ For H- and J-frame only. L-frame terminal nuts are metric only.

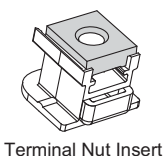

Table 124: Terminal Nuts for Bus Bar Connection of H-Frame and J-Frame Circuit Breakers

Description ¹	Frame	Tap	Cat. No.	Qty Per Kit	Torque
H-Frame Terminal Nut Insert–English	HD/HG/HJ/HL	1/4-20	S37425	2	80–90 lb-in (9–10.2 N•m)
H-Frame Terminal Nut Insert–English	HD/HG/HJ/HL	1/4-20	S37444	3	
H-Frame Terminal Nut Insert–Metric	HD/HG/HJ/HL	M6	S37426	2	
J-Frame Terminal Nut Insert–English	JD/JG/JJ/JL	1/4-20	S37427	2	80–90 lb-in (9–10.2 N•m)
J-Frame Terminal Nut Insert–English	JD/JG/JJ/JL	1/4-20	S37445	3	
J-Frame Terminal Nut Insert–Metric	JD/JG/JJ/JL	M8	S37428	2	

¹ Screws not included.



Table 125: Bar Dimensions

Dimension	H-Frame	J-Frame	L-Frame
A	0.250 in. (6.4 mm)	0.3125 in. (7.9 mm)	0.4 in. (10 mm)
B	0.125–0.375 in. (3.2–9.5 mm)	0.125–0.375 in. (3.2–5 mm)	0.11–0.39 in. (3–10 mm)
C	0.50 in. (12.7 mm)	0.50–0.75 in. (12.7–1.1 mm)	1.35 in. (32 mm)
D	0.3 in. (7.6 mm)	0.625 in. (15.9 mm)	<0.51 in. (13 mm)
E	0.3 in. (7.6 mm)	0.375 in. (9.5 mm)	0.64 in. (16 mm)

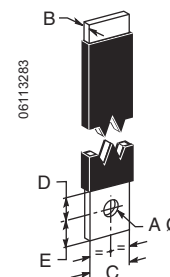
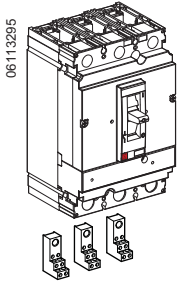

Table 126: L-Frame Bus Bar Connections Hardware

Description	Cat. No.
Set of 4 M10 x 25 terminal screws and washers for one side.	S36967

PowerPact™ H-, J-, and L-Frame Circuit Breakers

Circuit Breaker Mounting and Connections









Power Distribution Connectors

The power distribution connectors (PDC) can be used for multiple load wire connections on one circuit breaker. Use in place of standard distribution blocks to save space and time. Field installable kit includes tin-plated aluminum lug, connectors, and required mounting hardware.

- For use on load end of circuit breaker only
- For use in UL 508 Industrial Control applications
- For use in UL 1995/CSA C22.2 No. 236 heating and cooling equipment
- For copper wire only

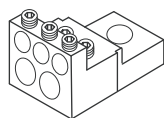
Table 127: Power Distribution Connectors

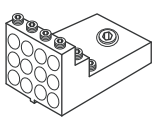
Frame		Kit Number	Qty per Kit	Wires per Terminal	Wire Range	Wire Binding Screw Torque
H-Frame		PDC6HD6	1	6	8–6 AWG (10–16 mm ²)	25 lb-in (2.8 N•m)
		PDC3HD2	1	3	2 AWG (35 mm ²)	40 lb-in (4.5 N•m)
J-Frame		PDC6JD4	1	6	8–4 AWG (10–25 mm ²)	35 lb-in (4.0 N•m)
		PDC3JD20	1	3 total 2 and 1	 14–6 AWG Cu (2.5–16 mm ²) or 4–1 AWG Cu (25–50 mm ²)	35 lb-in (4.0 N•m) 40 lb-in (4.5 N•m)
L-Frame		PDC5DG20L3	1	3 and 2	 4–1 AWG (25–50 mm ²) or 14–6 AWG (2.5–16 mm ²)	40 lb-in (4.5 N•m) 35 lb-in (4.0 N•m)
		PDC12DG4L3	1	3	12	8–4 AWG (10–25 mm ²)
					14–10 AWG (2.5–6 mm ²)	20 lb-in (2.3 N•m)

¹ Kit includes terminal shield.

See Table 130 for the phase barriers for power distribution connectors.

PowerPact™ H-, J-, and L-Frame Circuit Breakers Circuit Breaker Mounting and Connections

Compression Lugs

Both copper and aluminum compression lug kits are available for the H-, J-, and L-frame circuit breakers. Each kit contains required insulators and all mounting hardware. Compression lugs require the long lug cover pack, see Figure 31 on page 161.

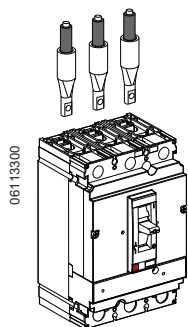

Table 128: Compression Lug Kits for Al/Cu Connectors

Circuit Breaker	Lug Kit	Rating at 75°C		Poles	Wires per Lug	Wire Range	Lugs per Terminal	Lugs per Kit
		Al	Cu					
Al/Cu Connectors								
H-Frame	YA060HD	≤ 60 A	≤ 60 A	3	1	6–2 AWG Cu or Al (16–35 mm ²)	1	3
	YA150HD	≤ 150 A	≤ 150 A	3	1	1/0–4/0 AWG Cu or Al (50–95 mm ²)	1	3
J-Frame	YA150JD	≤ 200 A	≤ 200 A	3	1	1–3/0 AWG Cu or Al (50–95 mm ²)	2	3
	YA250J35	≤ 250 A	≤ 250 A	3	1	3/0 AWG–350 kcmil Cu or Al (95–185 mm ²)	2	3
L-Frame	YA400L31K3	230 A	285 A	3	1	4-300 kcmil Al/Cu (25–150 mm ²)	1	3
	YA600L32K3	460 A	570 A	3	2	4-300 kcmil A/Cu (25–150 mm ²)	2	6
	YA400L51K3	310 A	380 A	3	1	2/0-500 kcmil A/Cu (70–240 mm ²)	1	3
	YA600L52K3	620 A	760 A	3	2	2/0-500 kcmil Al/Cu (70–240 mm ²)	2	6
	YA400L71K3	385 A	475 A	3	1	500-750 kcmil A (240–400 mm ²) 500 kcmil Cu (240 mm ²)	1	3
	YA600L32K4	460 A	570 A	4	2	4-300 kcmil A/Cu (25–150 mm ²)	1	8
	YA400L51K4	310 A	380 A	4	1	2/0-500 kcmil Al/Cu (70–240 mm ²)	2	4
	YA600L52K4	620 A	760 A	4	2	2/0-500 kcmil Al/Cu (70–240 mm ²)	1	8
	YA400L71K4	385 A	475 A	4	1	500-750 kcmil Al (240–400 mm ²) 500 kcmil Cu (240 mm ²)	2	4

PowerPact™ H-, J-, and L-Frame Circuit Breakers

Circuit Breaker Mounting and Connections

Table 129: Compression Lug Kits for Cu Connectors

Circuit Breaker	Lug Kit	Rating @ 75 C		Poles	Wires per Lug	Wire Range	Lugs per Terminal	Lugs per Kit
		Al	Cu					
H-Frame	CYA060HD	—	≤ 60 A	3	1	6–1/0 AWG Cu (16–50 mm ²)	1	3
	CYA150HD	—	≤ 150 A	3	1	4–2/0 AWG Cu (25–70 mm ²)	1	3
J-Frame	CYA150JD	—	≤ 150 A	3	1	4–2/0 AWG Cu (25–70 mm ²)	2	3
	CYA250J3	—	≤ 250 A	3	1	2/0 AWG–300 kcmil Cu (70–185 mm ²)	2	3
L-Frame	CYA400L31K3	—	285 A	3	1	2/0–300 kcmil Cu (70–150 mm ²)	1	3
	CYA600L32K3	—	570 A	3	2	2/0–300 kcmil Cu (70–150 mm ²)	2	6
	CYA400L51K3	—	380A	3	1	250–500 kcmil Cu (150–240 mm ²)	1	3
	CYA600L52K3	—	760A	3	2	250–500 kcmil Cu (150–240 mm ²)	2	6
	CYA400L71K3	—	475 A	3	1	500–750 kcmil Al (240–400 mm ²) 500 kcmil Cu (240 mm ²)	1	3
	CYA400L31K4	—	285A	4	1	2/0–300 kcmil Cu (70–150 mm ²)	1	4
	CYA600L32K4	—	570 A	4	2	2/0–300 kcmil Cu (70–150 mm ²)	2	8
	CYA400L51K4	—	380 A	4	1	250–500 kcmil Cu (150–240 mm ²)	1	4
	CYA600L52K4	—	760 A	4	2	250–500 kcmil Cu (150–240 mm ²)	2	8

PowerPact™ H-, J-, and L-Frame Circuit Breakers Circuit Breaker Mounting and Connections

Terminal Shields

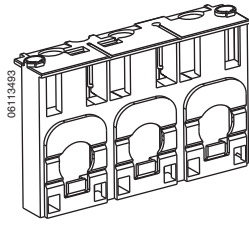

H-Frame Short Lug Shield

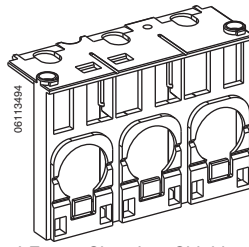

J-Frame Short Lug Shield

Table 130: Terminal Shields and Phase Barriers

Used With	Description			Dimension B (in.)	Cat. No.	Qty Per Kit	
H- and J-Frame Mechanical Lugs	Short Lug Shield	Frame	Max. Wire Size				
		H-Frame 60 A	3 AWG	0.50	S37446	1	
		H-Frame 150 A	3/0 AWG	0.50	S37447	1	
		J-Frame	350 kcmil	0.24	S37448	1	
H- and J-Frame Power Distribution Connectors and Compression Lugs	H-Frame Long Lug Shield	Compatible with:			2.24	S37449	1
		PDC	Compression Lugs				
			Aluminum	Copper			
		PDC6HD6	YA060HD	CYA060HD			
		PDC3HD2	YA150HD	CYA150HD			
	J-Frame Long Lug Shield	PDC6JD4	YA150JD	CYA150JD	1.68	S37450	1
PDC3JD2			CYA250J3				

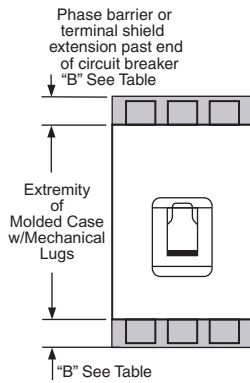

NOTE: L-frame terminal shields are shipped with the mechanical lug kits, see Table 121.

Section 10—Installation Recommendations

Operating Conditions

Temperature Derating

- PowerPact™ H-, J-, and L-frame circuit breakers may be used between -13°F and 158°F (-25 °C and +70 °C). For temperatures higher than 104° F (40° C) inside the enclosure, devices must be derated.
- Circuit breakers should be put into service under normal ambient, operating-temperature conditions.
- The permissible storage-temperature range for PowerPact H-, J-, and L-frame circuit breakers in the original packing is -58°F¹ and 185°F (-50 °C¹ and +85 °C).

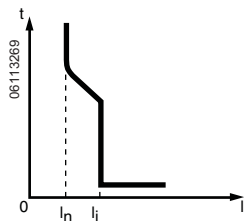

H-Frame Trip Curve

- (I_n) Fixed threshold thermal protection against overload
- (I_i) Fixed threshold instantaneous protection against short circuits

Table 131: Temperature Derating for H-Frame Trip Unit Thermal Protection—Long-Time

Temperature ¹		Rating (A) I _n															
°C	°F																
-10	14	23	30	38	46	53	60	68	76	88	103	112	123	137	160	180	221
0	32	21	28	36	43	49	56	63	71	83	97	107	117	131	151	171	207
10	50	20	26	33	40	46	52	59	66	77	90	101	111	126	141	161	194
20	68	18	24	31	37	42	48	54	62	72	84	96	105	120	132	152	180
30	86	17	22	28	34	39	44	50	56	66	77	88	98	110	121	139	165
40	104	15	20	25	30	35	40	45	50	60	70	80	90	100	110	125	150
50	122	12	17	21	25	30	34	38	43	53	62	72	80	86	95	109	131
60	140	9	14	17	20	24	28	31	35	46	53	63	70	72	80	93	111

¹ Shaded areas indicate temperature derated values, non-shaded areas inside an enclosure are standard circuit breaker ampere ratings at 104° F (40° C°).

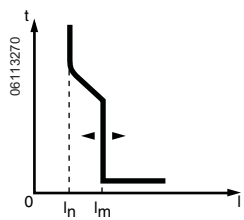

J-Frame Trip Unit

- (I_n) Fixed threshold thermal protection against overload
- (I_m) Adjustable instantaneous protection against short circuits

Table 132: Temperature Derating for J-Frame Trip Unit Thermal Protection—Long-Time

Temperature ¹		Rating (A) I _n					
°C	°F						
-10	14	221	264	289	330	377	
0	32	207	247	273	310	354	
10	50	194	230	256	290	330	
20	68	180	213	240	270	307	
30	86	165	194	220	248	279	
40	104	150	175	200	225	250	
50	122	131	150	176	193	214	
60	140	111	124	151	160	177	

¹ Shaded areas indicate temperature derated values, non-shaded areas are standard circuit breaker ampere ratings at 104° F (40° C°).

¹ -40°F (-40 °C) for Micrologic trip units with an LCD screen.

PowerPact™ H-, J-, and L-Frame Circuit Breakers Installation Recommendations

PowerPact H-, J- and L-Frame Circuit Breakers Equipped with Electronic Trip Units

Electronic trip units are not affected by variations in temperature. If the trip units are used in high-temperature environments, the Micrologic™ trip unit setting must nevertheless take into account the temperature limits of the circuit breaker.

Changes in temperature do not affect measurements by electronic trip units.

- The built-in CT sensors with Rogowski coils measure the current.
- The control electronics compare the value of the current to the settings defined for 104°F (40°C).

Because temperature has no effect on the CT measurements, the tripping thresholds do not need to be modified.

However, the temperature rise caused by the flow of current combined with the ambient temperature increases the temperature of the device. To avoid reaching the thermal withstand value, it is necessary to limit the current flowing through the device, that is the maximum I_r setting as a function of the temperature.

The table below indicates the maximum long-time (LT) protection setting I_r (A) depending on the ambient temperature.

Table 133: Derating Circuit Breakers with Micrologic Trip Units

Type of Device	Rating	Temperature						
		104°F (40°C)	113°F (45°C)	122°F (50°C)	131°F (55°C)	140°F (60°C)	149°F (65°C)	158°F (70°C)
H-Frame								
Unit-mount, plug-in or drawout	60 A	No derating						
	100 A	No derating						
	150 A	No derating						
J-Frame								
Unit-mount	250	250	250	250	245	237	230	225
Plug-in or drawout	250	250	245	237	230	225	220	215
L-Frame								
Unit-mount	400	400	400	400	390	380	370	360
Plug-in or drawout	400	400	390	380	370	360	350	340
Unit-mount	600	600	600	600	585	570	550	535
Plug-in or drawout	600	570	550	535	520	505	490	475

Example. A unit-mount PowerPact L-frame circuit breaker equipped with a Micrologic can have a maximum I_r setting of:

- 400 A up to 122°F (50 °C)
- 380 A up to 140°F (60 °C)

PowerPact™ H-, J-, and L-Frame Circuit Breakers

Installation Recommendations

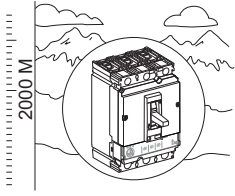

Altitude derating

Altitude does not significantly affect the characteristics of PowerPact H-, J-, and L-frame circuit breakers up to 6560 ft (2000 m). Above this altitude, it is necessary to take into account the decrease in the dielectric strength and cooling capacity of air.

The following table gives the corrections to be applied for altitudes above 6560 ft (2000 m). The breaking capacities remain unchanged.

Table 134: Altitude Derating

Altitude		6560 ft (2000 m)	9840 ft (3000 m)	13120 ft (4000 m)	16400 ft (5000 m)
Dielectric withstand voltage		3000 V	2500 V	2100 V	1800 V
Insulation voltage	V_i	800 V	700 V	600 V	500 V
Maximum operational voltage	V_e	690 V	590 V	520 V	460 V
Average current capacity (A) at 104°F (40°C)	$I_n \times$	1.0	0.96	0.93	0.9

400 Hz Derating

Application of H- and J-frame circuit breakers at frequencies above 60 Hz requires that special consideration be given to the effects of high frequency on the circuit breaker characteristics. Thermal and instantaneous operations must be treated separately.

At frequencies below 60 Hz, the thermal derating of PowerPact H and J-frame circuit breakers is negligible. However, at frequencies above 60 Hz, thermal derating is required.

One of the most common high frequency applications is at 400 Hz.

Table 135: 400 Hz Derating

Circuit Breaker	400 Hz Derating Multiplier
H-Frame	0.95
J-Frame	0.90
L-Frame, 400 A	0.80
L-Frame, 600 A	0.65

For more information, refer to Data Bulletin 0100DB0101, *Determining Current Carrying Capacity in Special Applications*.

Installation in Equipment

Power from the Top or Bottom

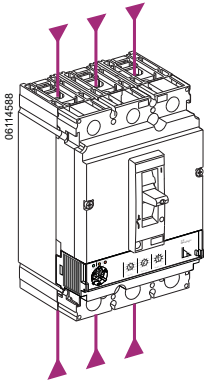

PowerPact H-, J-, and L-frame circuit breakers with factory-sealed trip units can be supplied from either the top or the bottom without any reduction in performance. This capability facilitates connection when installed in end-use equipment.

All connection and insulation accessories can be used on circuit breakers supplied either from the top or bottom.

Weight

The table below presents the weights of the circuit breakers and the main accessories, which must be summed to obtain the total weight. The values are valid for all performance categories.

Table 136: Weights

Type of Device		Circuit Breakers	Base	Cradle	Motor Operator
H-frame, 100 A	2P	3.95 lb (1.79 kg)	1.75 lb (0.8 kg)	4.85 lb (2.2 kg)	2.65 lb (1.2 kg)
	3P	4.52 lb (2.05 kg)	1.75 lb (0.8 kg)	4.85 lb (2.2 kg)	2.65 lb (1.2 kg)
H-frame, 150 A	2P	4.08 lb (1.85 kg)	1.75 lb (0.8 kg)	4.85 lb (2.2 kg)	2.65 lb (1.2 kg)
	3P	4.85 lb (2.2 kg)	1.75 lb (0.8 kg)	4.85 lb (2.2 kg)	2.65 lb (1.2 kg)
J-frame, 250 A	3P	5.29 lb (2.4 kg)	1.75 lb (0.8 kg)	4.85 lb (2.2 kg)	2.65 lb (1.2 kg)
L-frame, 600 A	3P	13.65 lb (6.19 kg)	5.29 lb (2.4 kg)	4.85 lb (2.2 kg)	6.17 lb (2.8 kg)
	4P	17.92 lb (8.13 kg)	6.17 lb (2.8 kg)	4.85 lb (2.2 kg)	6.17 lb (2.8 kg)

Safety Clearances and Minimum Distances

General Rules

When installing a circuit breaker, minimum distances (safety clearances) must be maintained between the device and panels, bars and other protection devices installed nearby. These distances, which depend on the voltage, are defined by tests carried out in accordance with UL standards.

If installation is not checked by type tests, it is also necessary to:

- use insulated bars for circuit-breaker connections
- segregate the busbars using phase barriers

For PowerPact H-, J-, and L-frame devices, terminal shields and interphase barriers are recommended and may be mandatory depending on the operating voltage of the device and type of installation (unit-mount, drawout, etc.).

Power Connections

The table below indicates the connection requirements for PowerPact H-, J-, and L-frame devices to ensure insulation of live parts for the various types of connection.

- unit-mount devices with front connection or rear connection
- plug-in or drawout devices.

Connection accessories such as crimp lugs, terminal extensions (straight, right-angle, double-L and 45°) and spreaders are supplied with interphase barriers. Long terminal shields provide a degree of protection of IP40 (ingress).

PowerPact™ H-, J-, and L-Frame Circuit Breakers Installation Recommendations

Safety Clearance

H- and J-Frame Safety Clearances

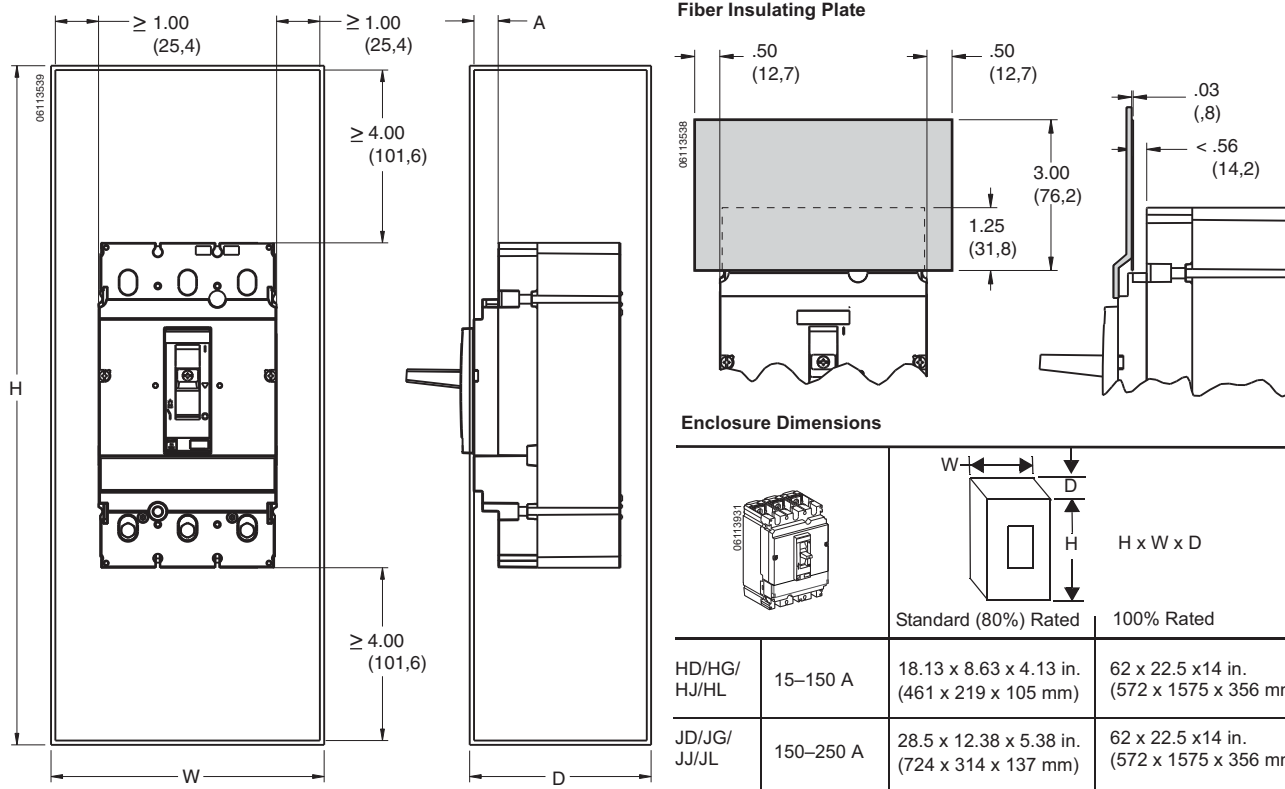

If dimension A < 0.56 in., attach fiber insulating plate, not provided, to enclosure cover.

Table 137: Minimum Safety Clearances

Operating Voltage	Clearance						
	Between Devices	Between Device and Sheet Metal					
		Painted Sheet Metal			Bare Sheet Metal		
V ≤ 440 V for devices equipped with:							
• No accessories	0	0	30	30	5	40	40
• Interphase barriers	0	0	0	0	0	0	0
• Long terminal shields	0	0	0	0	0	0	0
440 < V ≤ 600 for devices equipped with:							
• Interphase barriers ¹	0	0	0	0	20	10	10
• Long terminal shields	0	0	0	0	10	10	10
V > 600 V for devices equipped with:							
• Long terminal shields	0	10	50	50	20	100	100

¹ Only for J-frame devices.

PowerPact™ H-, J-, and L-Frame Circuit Breakers Installation Recommendations

Clearances with Respect to Live Bare Busbars

Table 138: Minimum Safety Clearances to Bare Busbars

Operating Voltage	Clearances to Live Bare Busbars ¹			
	Spacing ≤ 60 mm		Spacing > 60 mm	
V ≤ 440 V	350	350	80	80
440 V < V ≤ 600 V	350	350	120	120

¹ These clearances can be reduced for special installations as long as the configuration is checked by tests.

Control Wiring

Remote Tripping by Undervoltage Trip (MN) or Shunt Trip (MX)

Power requirements are approximately:

- 30 VA for pick-up of the undervoltage trip (MN) and shunt trip (MX)
- 300–500 VA for the motor operator.

Table 139: Recommended Maximum Cable Lengths¹

Power Supply Voltage (Vdc)		12 Vdc		24 Vdc		48 Vdc	
Cable cross-section		16 AWG (1.5 mm ²)	14 AWG (2.5mm ²)	16 AWG (1.5 mm ²)	14 AWG (2.5mm ²)	16 AWG (1.5 mm ²)	14 AWG (2.5mm ²)
Undervoltage Trip (MN)	V source 100%	49 ft (15 m)	—	525 ft (160 m)	—	2100 ft (640 m)	—
	V source 85%	23 ft (7 m)	—	131 ft (40 m)	—	525 ft (160 m)	—
Shunt Trip (MX)	V source 100%	197 ft (60 m)	—	787 ft (240 m)	—	3150 ft (960 m)	—
	V source 85%	98 ft (30 m)	—	394 ft (120 m)	—	1575 ft (480 m)	—
Motor Operator	V source 100%	—	—	33 ft (10 m)	16 m	213 ft (65 m)	361 ft (110 m)
	V source 85%	—	—	6.6 ft (2 m)	4 m	56 ft (17 m)	82 ft (25 m)

¹ The indicated length is that of each of the two wires.

External Neutral Voltage Tap (ENVT)

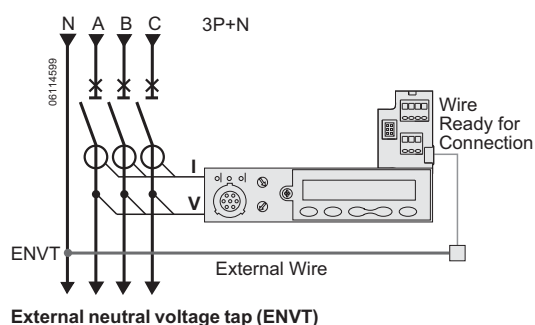

This connection is required for accurate power measurements on 3-pole circuit breakers equipped with Micrologic 5 / 6 E trip units in installations with a distributed neutral. It can be used to measure phase-neutral voltages and calculate power using the 3 wattmeter method.

PowerPact H-, J-, and L-frame 3-pole circuit breakers come with a wire installed on the device for the connection to the ENVT. This wire is equipped with a connector for connection to an external wire with:

- cross-sectional area of 18–14 AWG (1 mm² to 2.5 mm²)
- maximum length of 32.8 ft (10 m).

PowerPact™ H-, J-, and L-Frame Circuit Breakers Installation Recommendations

External Neutral Current Transformer (ENCT)

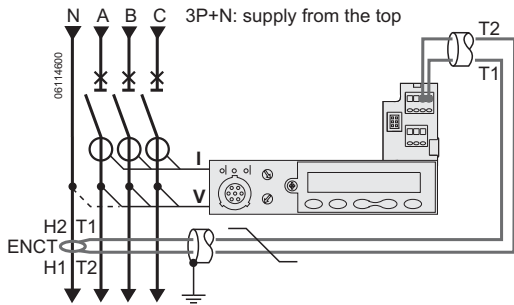

This connection is required to protect the neutral on 3-pole circuit breakers equipped with Micrologic 5 / 6 A or E trip units in installations with a distributed neutral. For Micrologic 6 A or E, it is required for ground-fault protection.

The ENCT is connected in the same way for unit-mount, plug-in or drawout devices:

- unit-mount devices are connected using terminals T1 and T2 of the internal terminal block.
- plug-in and drawout devices are not connected using the auxiliary terminals.

The wires must be connected/disconnected inside the devices using terminals T1 and T2.

The ENCT must be connected to the Micrologic trip unit by a shielded twisted pair. The shielding should be connected to the enclosure earth only at the CT end, no more than 12 in. (30 cm) from the CT.

- the power connections of the CT to the neutral (H2 and H1) must be made in the same way for power supply from the top or the bottom (see figure). Make sure they are not reversed for devices with power supply from the bottom.
- cross-sectional area of 22–16 AWG (0.4 mm² to 1.5 mm²)
- maximum length of 32.8 ft (10 m).

ULP Connection System Between Micrologic, FDM121 Module and Modbus™ Interface

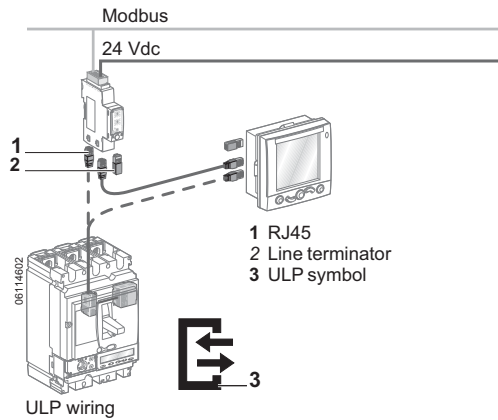

ULP connection system.

The ULP (Universal Logic Plug) wiring system used by H-, J- and L-frame circuit breakers for connection through the Modbus network requires neither tools nor settings. The prefabricated cables are used for both data transfer and distribution of 24 Vdc power. Connectors on each component are identified by ULP symbols, ensuring total compatibility between each component.

A line terminator must be fitted to all components with an unused RJ45 connector.

Table 140: Available Cables

Cable	Available Lengths
NSX cord for connection of the internal terminal block to the Modbus interface or the FDM121 display using an RJ45 connector.	4.27 ft (1.3 m)
	9.84 ft (3 m)
ULP cables with RJ45 connectors at each end for the other connections between ULP wiring components	0.98 ft (0.3 m)
	1.97 ft (0.6 m)
	3.28 ft (1 m)
	2.56 ft (2 m)
	9.84 ft (3 m)
For greater distances, two cables can be interconnected using the RJ45 female/ female connector. Maximum length of 32.8 ft (10 m) between 2 modules and 98.4 ft (30 m) in all.	16.4 ft (5 m)

24 Vdc Power Supply Module

An external 24 Vdc power supply is required for installations with communication networks, regardless of the type of trip unit.

On installations without communication networks, the power supply is available as an option for Micrologic 5/6 to:

- modify settings when the circuit breaker is open (OFF position)
- display measurements when the current flowing through the circuit breaker is low
- maintain the display of the cause of tripping.

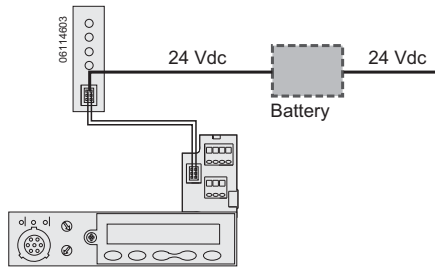

Power supply, without the Communication function, using the terminal block with a backup battery.

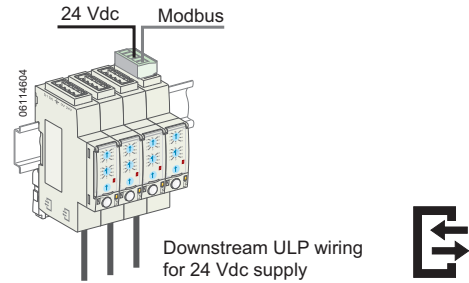

Power supply, with the communication function, using the Modbus interface.

To determine power requirements of devices, see page 84.

PowerPact™ H-, J-, and L-Frame Circuit Breakers

Installation Recommendations

Wiring

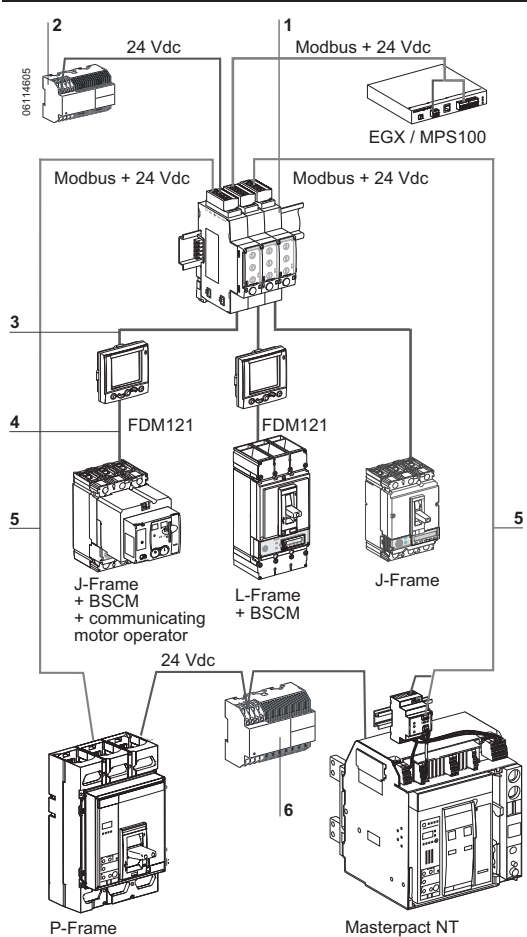

- 1 Modbus interface module with connection accessory.
- 2 24 Vdc power supply of Micrologic for Powerpact H-, J-, and L-Frame communication modules.
- 3 ULP cord.
- 4 NSX cord.
- 5 Modbus cable + 24 Vdc part no. 50965 (Schneider Electric) recommended or part no. 7895A (Belden).
- 6 24 Vdc power supply of Micrologic for PowerPact M-Frame/ Masterpact circuit breakers.

Micrologic 5 or 6 Without the Communication Function

The external 24 Vdc supply is connected through the circuit breaker terminal block.

Use of a 24 Vdc battery provides backup power for approximate 3 hours (100 mA) in the event of an interruption in the external supply.

Micrologic 5 or 6 With the Communication Function

The external 24 Vdc supply is connected through the Modbus interface using a five-pin connector, including two for the power supply. Stacking accessories (see page 81) can be used to supply a number of interfaces by fast clip-on connection.

The 24 Vdc power is distributed downstream by the ULP (Universal Logic Plug) communication cables with RJ45 connectors. This system ensures both data transfer and power distribution to the connected modules.

Recommendations for 24 Vdc Wiring

Do not connect the positive terminal to ground

- Do not connect the negative terminal to ground.
- The maximum length for each conductor (+/-) is 33 ft (10 m).
- For connection distances greater than ten metres, the plus and minus conductors of the 24 Vdc supply must be twisted to improve EMC.
- The 24 Vdc conductors must cross the power cables perpendicularly. If this is difficult or impossible, the plus and minus conductors must be twisted.

Modbus

Each PowerPact H-, J-, and L-frame circuit breaker equipped with Micrologic 5/6 and an FDM121 display is connected to the Modbus network using the Modbus com module. Connection of all the circuit breakers and other Modbus devices in the equipment to a Modbus bus is made much easier by using a Modbus RJ45 junction block installed in the equipment.

Recommendations for Modbus Wiring:

- The shielding may be grounded on one end only
- The conductors must be twisted to improve immunity (EMC)
- The Modbus conductors must cross the power cables perpendicularly

Example.

A unit-mount PowerPact L-frame circuit breaker with a Micrologic trip unit can have a maximum I_r setting of:

- 400 A up to 122°F (50 °C)
- 380 A up to 140°F (60 °C)

Section 11—Wiring Diagrams

Unit-Mount Circuit Breakers

Power	Micrologic Trip Unit ¹	Remote Operation
-------	-----------------------------------	------------------

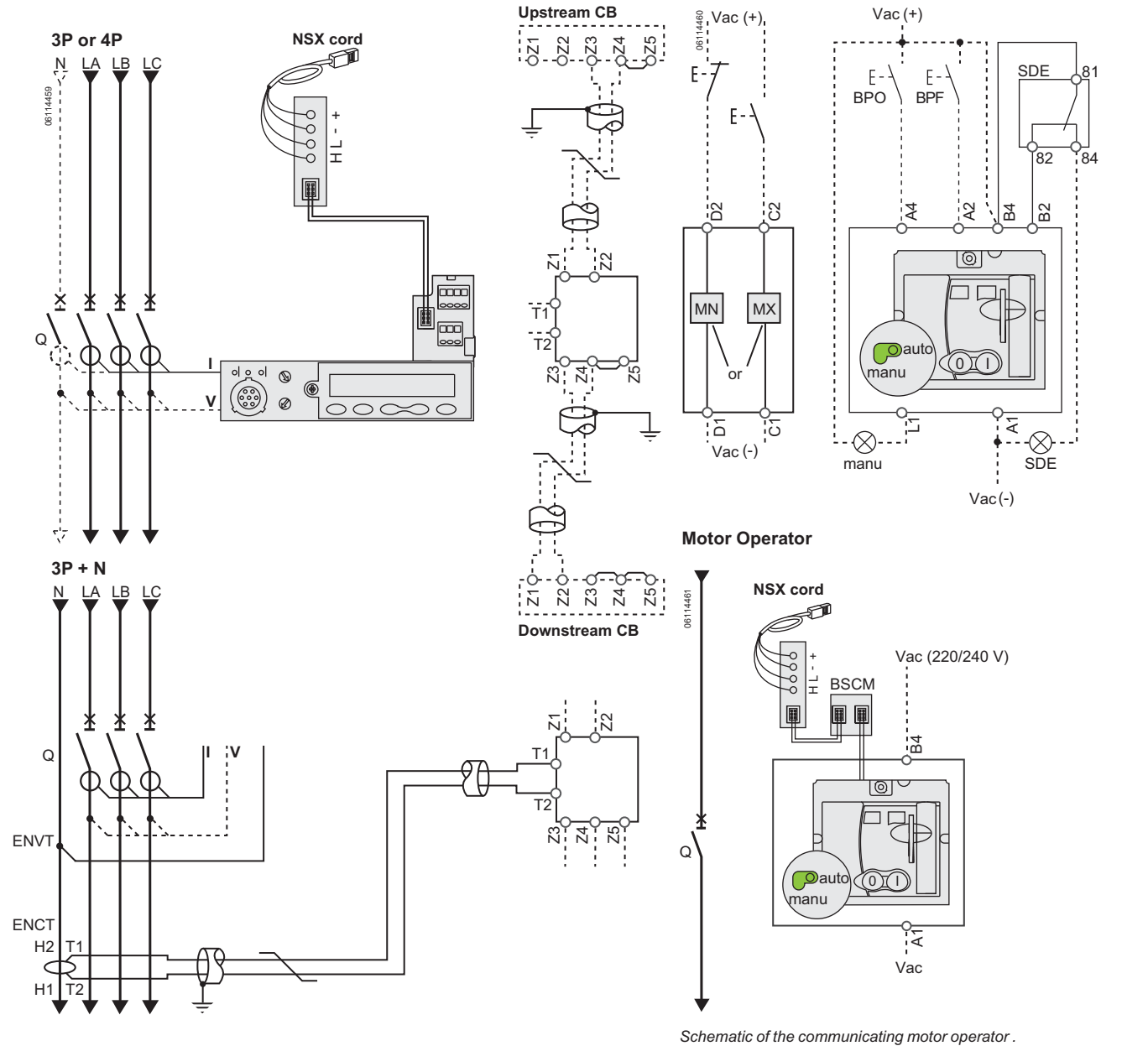

Schematic of the communicating motor operator.

Communicating Motor Operator

Continued on next page

Unit-Mount Circuit Breakers *(continued)*

Indication Contacts

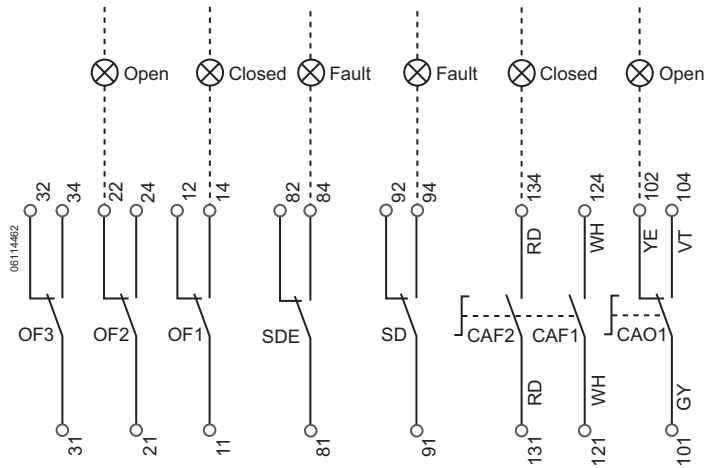

The diagram is shown with circuits de-energized, relays in normal position, and all devices open, connected, and charged. Terminal connections shown as O must be connected by the customer.

Micrologic Trip Unit A or E

	Communication
A/E	H (WH), L(BL): data -(BK), +(RD): 24 Vdc power supply
<hr/>	
	ZSI (Zone Selective Interlocking)
	Z1: ZSI OUT SOURCE
	Z2: ZSI OUT
A/E	Z3: ZSI IN SOURCE
	Z4: ZSI IN ST (short time)
	Z5: ZSI IN GF (ground fault)
	(Z3, Z4, and Z5 for L-frame circuit breaker only)
<hr/>	
A/E	ENCT: External Neutral Current Transformer: -Shielded cable with 1 twisted pair (T1, T2) -Shielding earthed at CT end only Connection L = 12 in. (30 cm) max. -Maximum length of 33 ft (10 m) -Cable size of 22 AWG -Recommended cable: Belden 9451SB or equivalent
<hr/>	
E	ENVT: External Neutral Voltage Tap for Connection to the Neutral using a 3P Circuit Breaker

Color Code for Auxiliary Wiring

RD: Red	VI: Violet
WH: White	GY: Gray
YE: Yellow	OR: Orange
BK: Black	BL: Blue
GN: Green	

Remote Operation

MN Undervoltage Release

or

MX Shunt Release

Motor Operator

A4 Opening Order

A2 Closing Order

B4, A1 Power Supply to Motor Operator

L1 Manual Position (manu)

B2 Overcurrent Trip Switch Interlocking (mandatory for correct operation)

BPO Opening Pushbutton

BPF Closing Pushbutton

Communicating Motor Operator

B4, A1 Motor Operator Power Supply

BSCM Breaker Status and Control Module

Indication Contacts

OF2/OF1 Device ON/OFF Auxiliary Switches

OF3 Device ON/OFF Auxiliary Switches (L-Frame)

SDE Overcurrent Trip Switch
(short-circuit, overload, ground fault, earth leakage)

SD Alarm Switch

CAF2/CAF1 Early-Make Contact (rotary handle only)

CAO1 Early-Break Contact (rotary handle only)

PowerPact™ H-, J-, and L-Frame Circuit Breakers Wiring Diagrams

Plug-In and Drawout Circuit Breakers

Power	Micrologic Trip Unit ¹	Remote Operation
-------	-----------------------------------	------------------

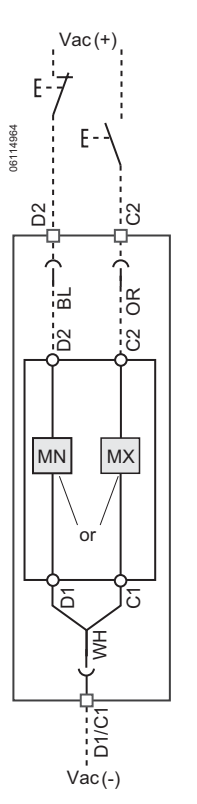
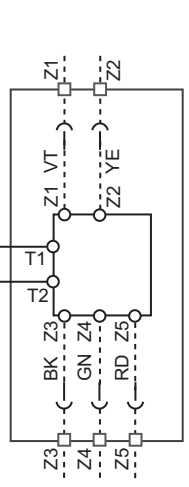
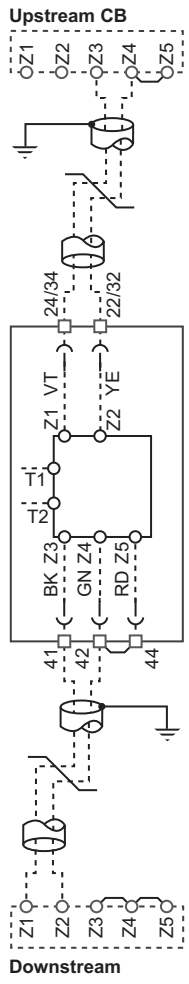
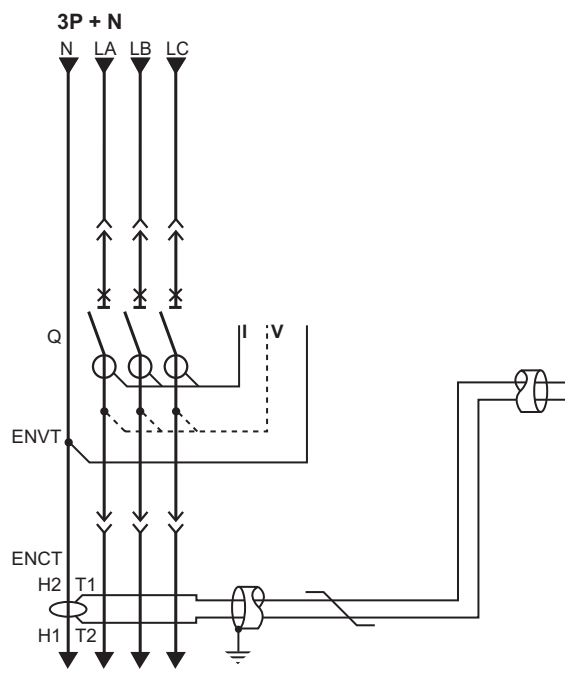
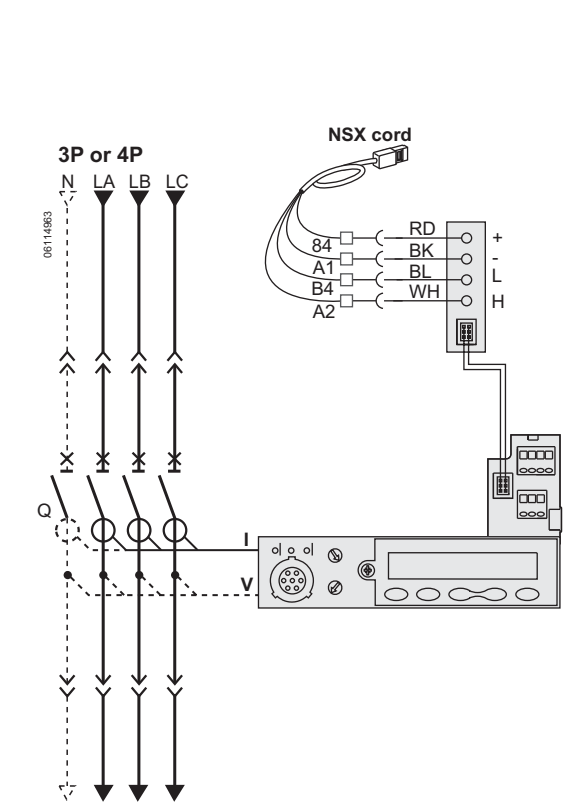

Motor Operator

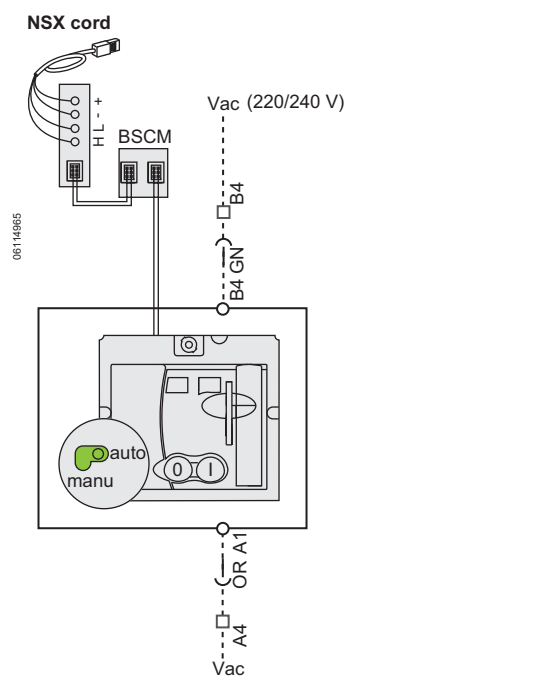

Communicating Motor Operator

Continued on next page

PowerPact™ H-, J-, and L-Frame Circuit Breakers Wiring Diagrams

Plug-In and Drawout Circuit Breakers (continued)

Indication Contacts

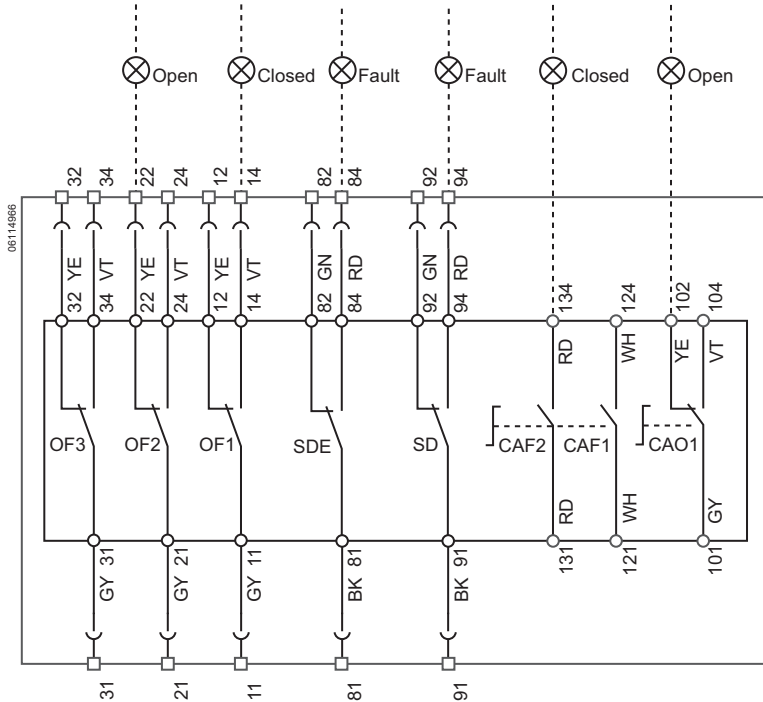

Carriage Switches

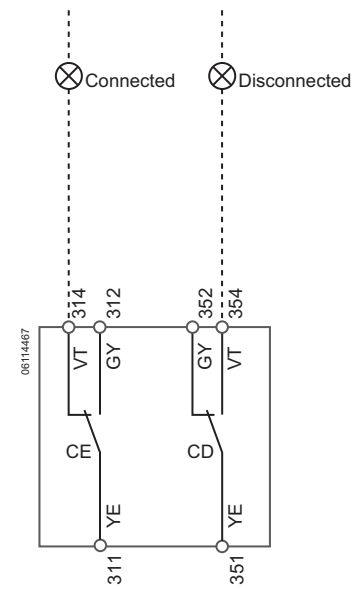

The diagram is shown with circuits de-energized, relays in normal position, and all devices open, connected, and charged.

Terminal connections shown as □ and O must be connected by the customer.

Micrologic Trip Unit A or E

	Communication
A/E	H (WH), L(BL): data -(BK), +(RD): 24 Vdc power supply
	ZSI (Zone Selective Interlocking)
	Z1: ZSI OUT SOURCE Z2: ZSI OUT
A/E	Z3: ZSI IN SOURCE Z4: ZSI IN ST (short time) Z5: ZSI IN GF (ground fault) (Z3, Z4, and Z5 for L-frame circuit breaker only)
A/E	ENCT: External Neutral Current Transformer: -Shielded cable with 1 twisted pair (T1, T2) -Shielding earthed at CT end only Connection L = 12 in. (30 cm) max. -Maximum length of 33 ft (10 m) -Cable size of 22 AWG -Recommended cable: Belden 9451SB or equivalent
E	ENVV: External Neutral Voltage Tap for Connection to the Neutral using a 3P Circuit Breaker

Color Code for Auxiliary Wiring

RD: Red	VI: Violet
WH: White	GY: Gray
YE: Yellow	OR: Orange
BK: Black	BL: Blue
GN: Green	

Remote Operation

MN	Undervoltage Release
or	
MX	Shunt Release

Motor Operator

A4	Opening Order
A2	Closing Order
B4, A1	Power Supply to Motor Operator
L1	Manual Position (manu)
B2	Overcurrent Trip Switch Interlocking (mandatory for correct operation)
BPO	Opening Pushbutton
BP	Closing Pushbutton

Communicating Motor Operator

B4, A1	Motor Operator Power Supply
BSCM	Breaker Status and Control Module

Indication Contacts

OF2/OF1	Device ON/OFF Auxiliary Switches
OF3	Device ON/OFF Auxiliary Switches (L-Frame)
SDE	Overcurrent Trip Switch (short-circuit, overload, ground fault, earth leakage)
SD	Alarm Switch
CAF2/CAF1	Early-Make Contact (rotary handle only)
CAO1	Early-Break Contact (rotary handle only)

PowerPact™ H-, J-, and L-Frame Circuit Breakers

Wiring Diagrams

Motor Operator

NOTE: The diagram is shown with circuits de-energized, relays in normal position, and all devices open, connected, and charged.

After tripping initiated by the “Push to trip” button, the undervoltage release (MN), or the shunt release (MX), device can be reset automatically, remotely, or manually.

Following tripping due to an electrical fault, reset must be carried out manually.

Motor Operator with Automatic Reset

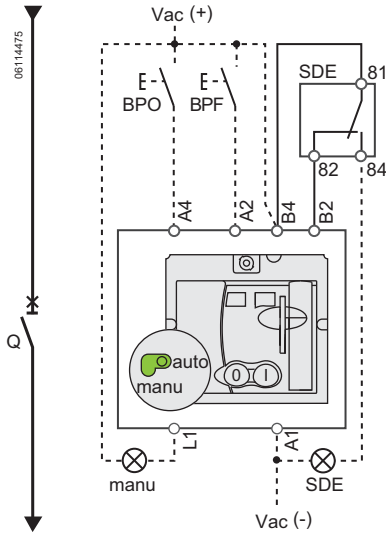

Motor Operator with Remote Reset

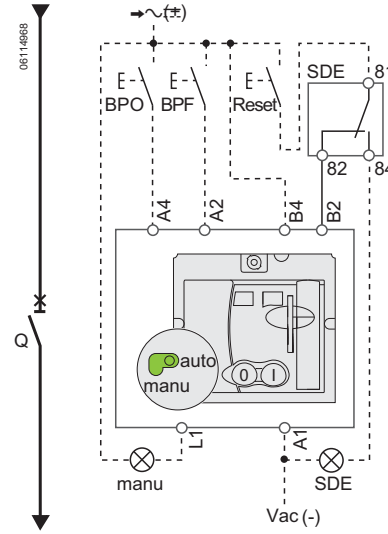

Symbols

- Q: Circuit Breaker
- A4: Opening Order
- A2: Closing Order
- B4, A1: Motor Operator Power Supply
- L1: Manual Position (manu)
- B2: Overcurrent Trip Switch Interlocking (mandatory for correct operation)
- BPO: Opening Pushbutton
- BPF: Closing Pushbutton
- SDE: Fault-Trip Indication Contact (short-circuit, overload, ground fault, earth leakage)

Motor Operator with Manual Reset

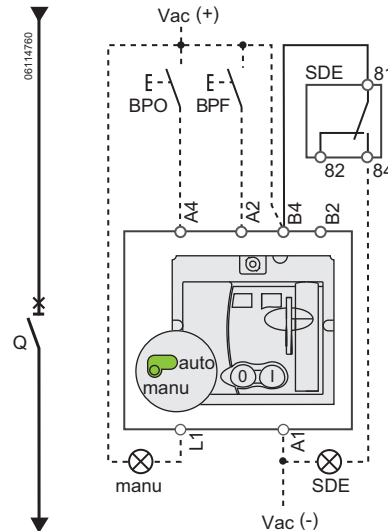

PowerPact™ H-, J-, and L-Frame Circuit Breakers Wiring Diagrams

Motor Operator *(continued)*

Symbols

- Q:** Circuit Breaker
- B4, A1:** Motor Operator Power Supply
- BSCM:** Breaker Status and Control Module

Communicating Motor Operator

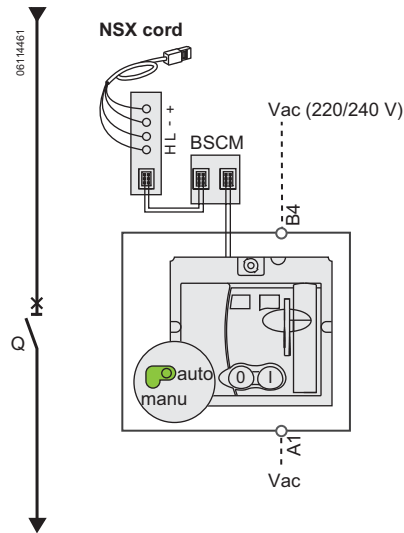

Schematic of the communicating motor operator.

RSU Screen for Communicating Motor Operator

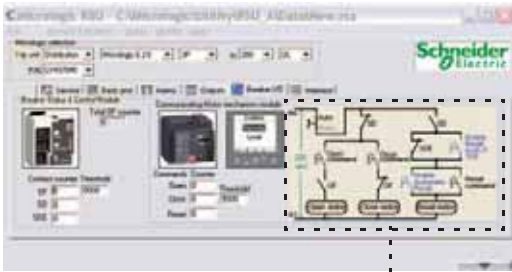

RSU utility setup screen for the communicating motor operator

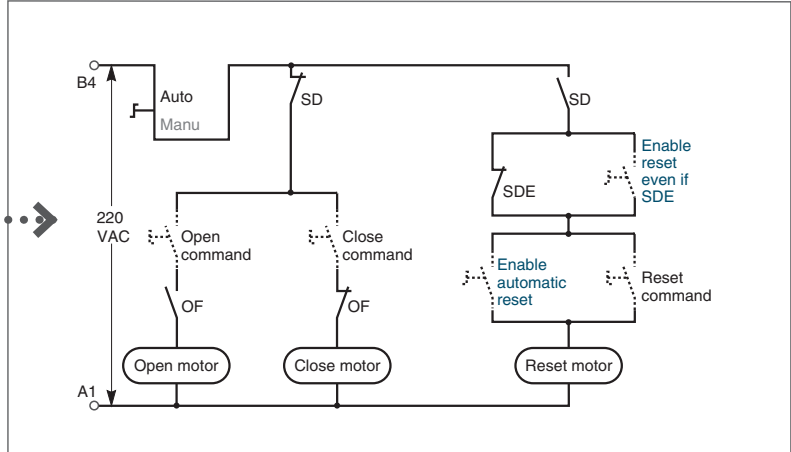

Single-line diagram of communicating motor operator

Opening, closing and reset orders are transmitted through the communication network. The "Enable automatic reset" and "Enable reset even if SDE" parameters must be set using the RSU software using the screen by clicking the blue text.

"Auto/Manu" is a switch on the front of the motor operator.

Terminal connections shown as O must be connected by the customer.

PowerPact™ H-, J-, and L-Frame Circuit Breakers

Wiring Diagrams

SDx Module with Micrologic™ Trip Unit

NOTE: The diagram is shown with circuits de-energized, relays in normal position, and all devices open, connected, and charged.

Symbols

- SD1, SD3:** SDx Module Power Supply
- SD2:** Output 1 (80 mA max.)
- SD4:** Output 2 (80 mA max.)

	SD2	SD4
Micrologic 3	SDT	—
Micrologic 5	SDT or Output 1	PAL I _r or Output 2
Micrologic 6	SDT or Output 1	SDG or Output 2

Terminal connections shown as O must be connected by the customer.

Connection

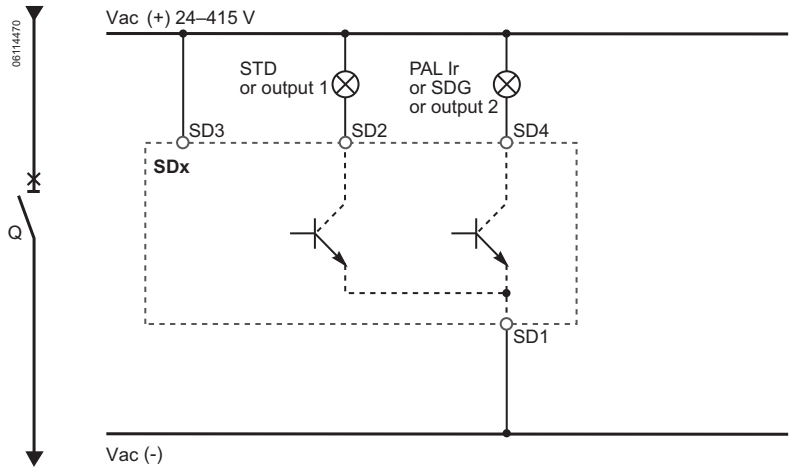

Operation

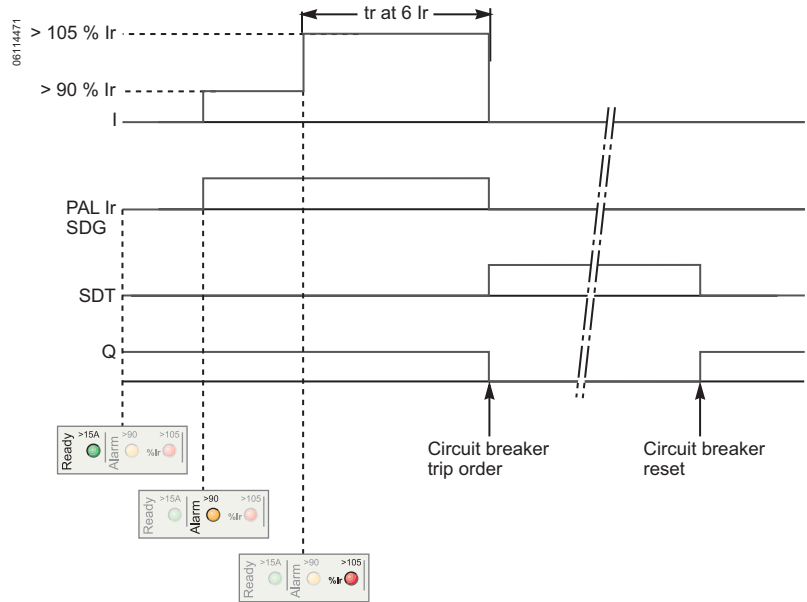

- I:** Charge Current
- PAL I_r:** Thermal Overload Pre-Alarm
- SDG:** Ground-Fault Signal
- SDT:** Thermal-Fault Signal
- Q:** Circuit Breaker

PowerPact™ H-, J-, and L-Frame Circuit Breakers Wiring Diagrams

SDTAM Module with Micrologic M Trip Unit

NOTE: The diagram is shown with circuits de-energized, relays in normal position, and all devices open, connected, and charged.

Symbols

SD1, SD3: SDTAM Module Power Supply
SD2: Thermal Fault Signal (80 mA max.)
SD4: Contactor Control Output (80 mA max.)

	SD2	SD4
Micrologic 2 M	SDT	KA1

Terminal connections shown as O must be connected by the customer.

Connection

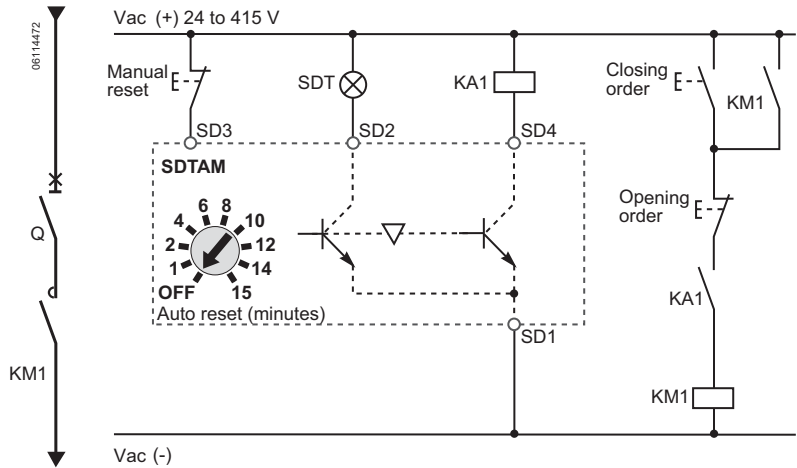

Operation

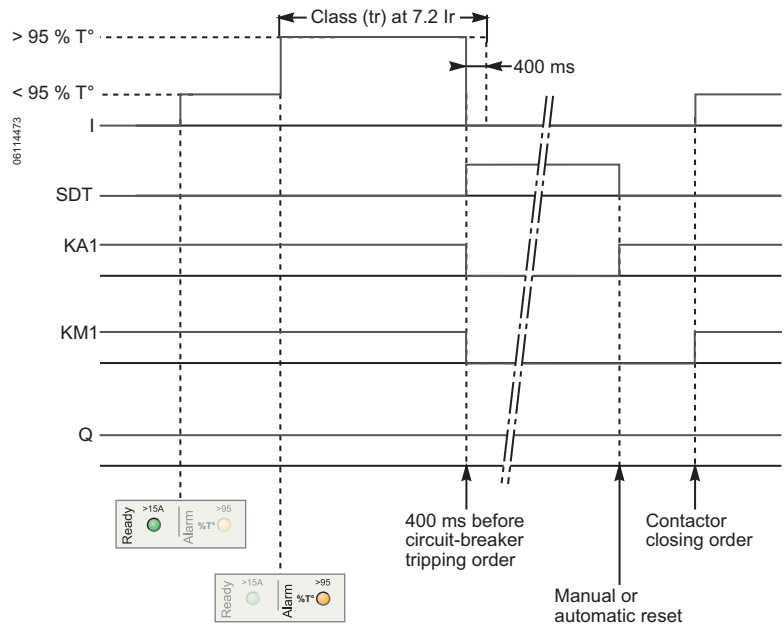

I: Charge Current
SDT: Thermal Fault Signal
KA1: Auxiliary Relay (RBN or RTBT Relay)
KM1: Motor Contactor
Q: Circuit Breaker

PowerPact™ H-, J-, and L-Frame Circuit Breakers Wiring Diagrams

Modbus™ Module

Detailed connection of the circuit breakers on communication network Modbus

Connection

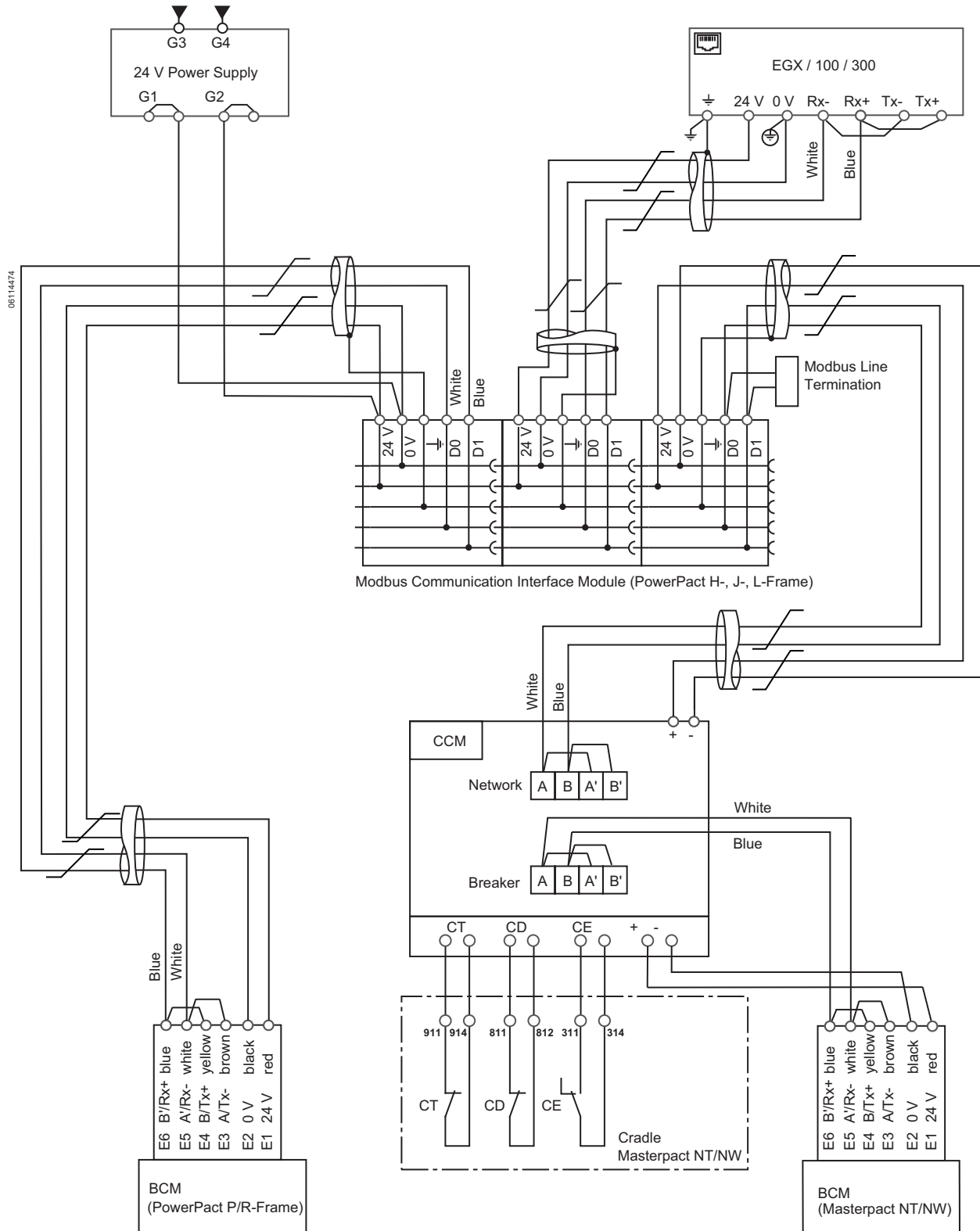

Section 12—Dimensions

PowerPact™ H-Frame Circuit Breakers

Figure 8: 15–150 A Bus Bar PowerPact H-Frame 2P HD/HG Thermal-Magnetic Only Circuit Breaker

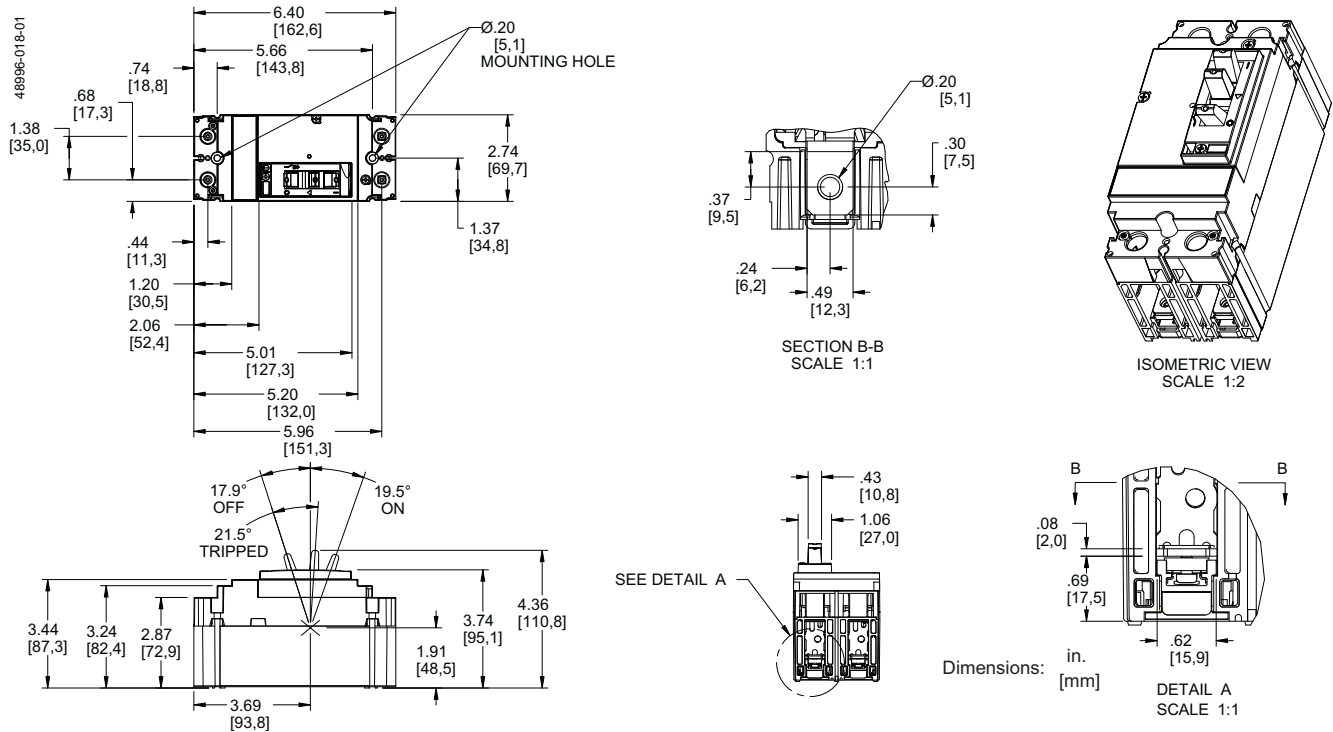

PowerPact™ H-, J-, and L-Frame Circuit Breakers Dimensions

Figure 9: 15–150 A Unit Mount PowerPact H-Frame 2P HD/HG Thermal-Magnetic Only Circuit Breaker

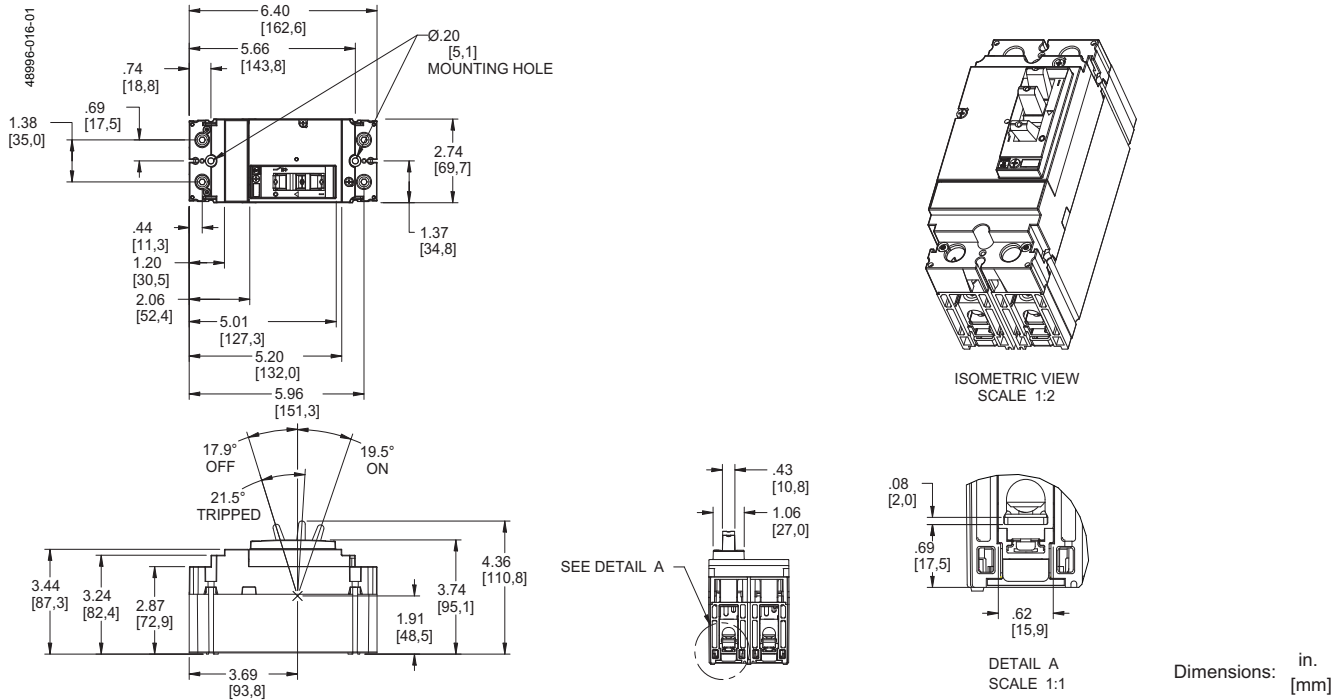
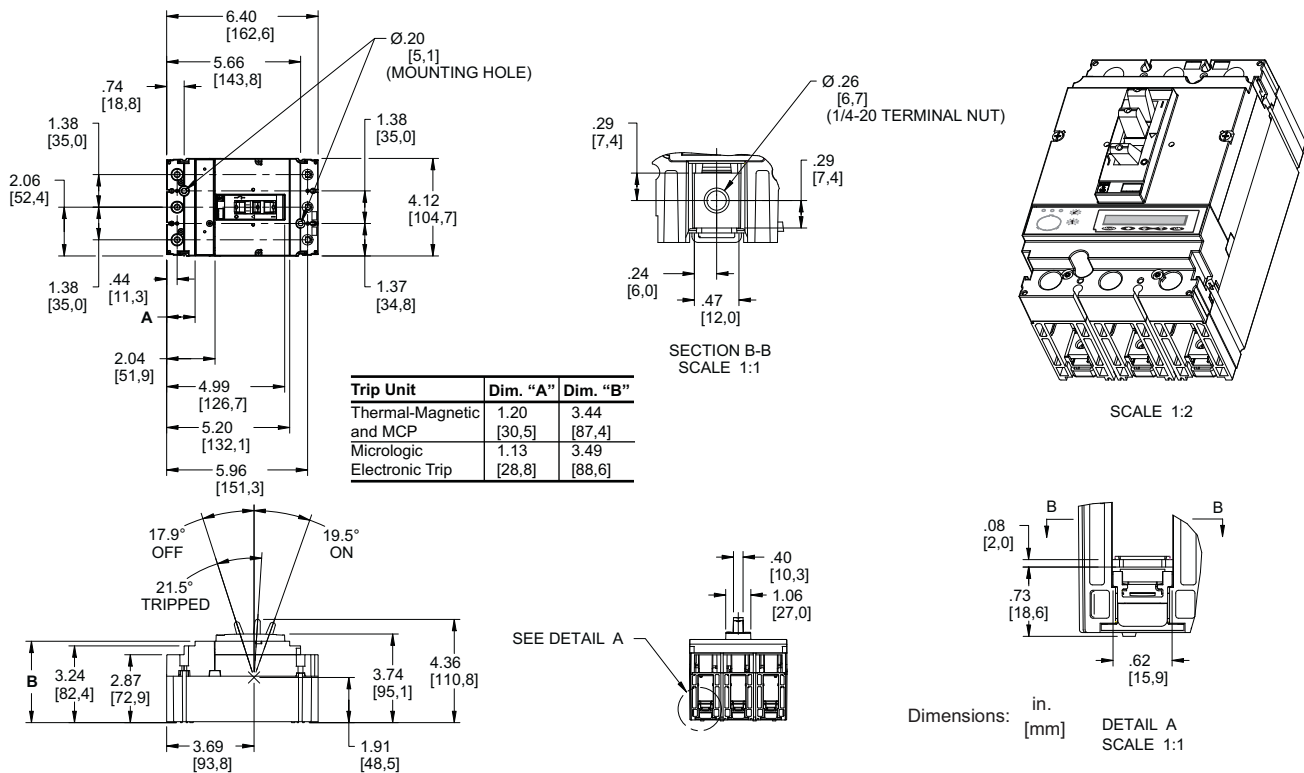

Figure 10: 15–150 A Bus Bar PowerPact H-Frame 3P Circuit Breaker



PowerPact™ H-, J-, and L-Frame Circuit Breakers Dimensions

Figure 11: 15–150 A Lug-Lug PowerPact H-Frame 3P Circuit Breaker

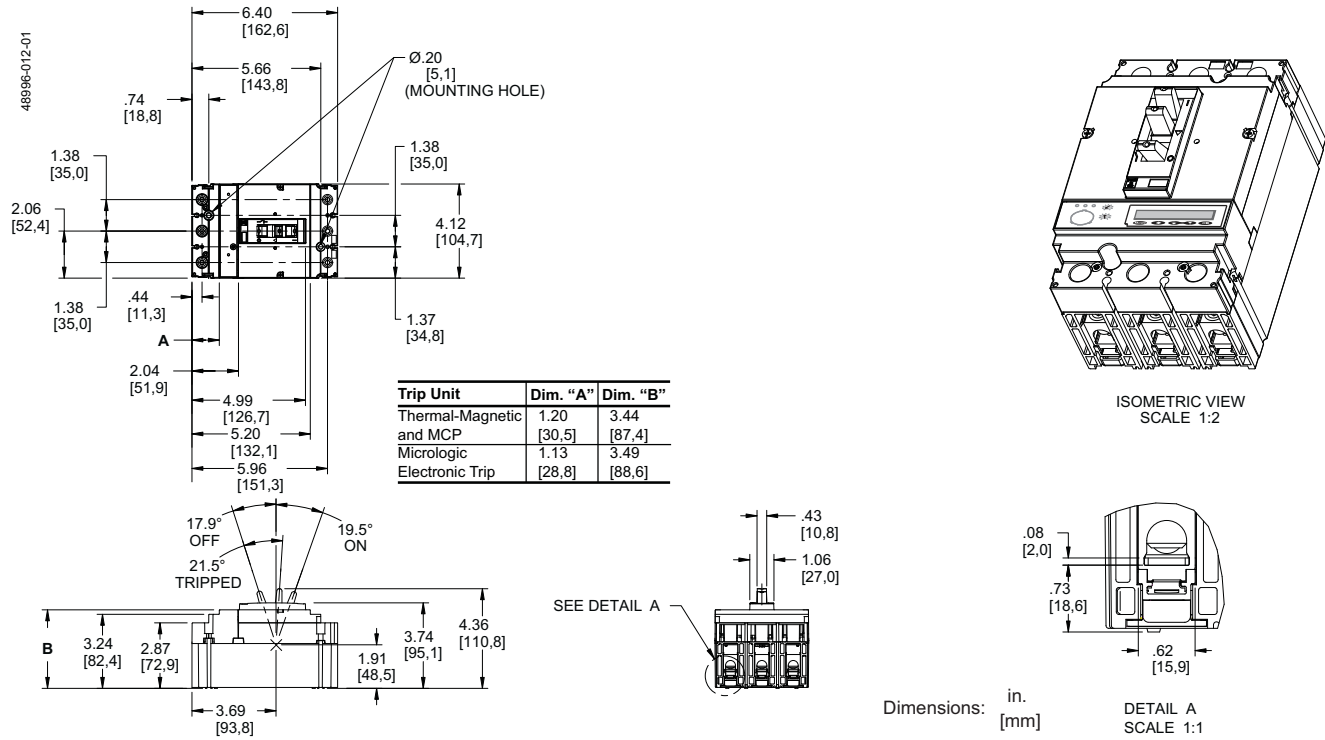
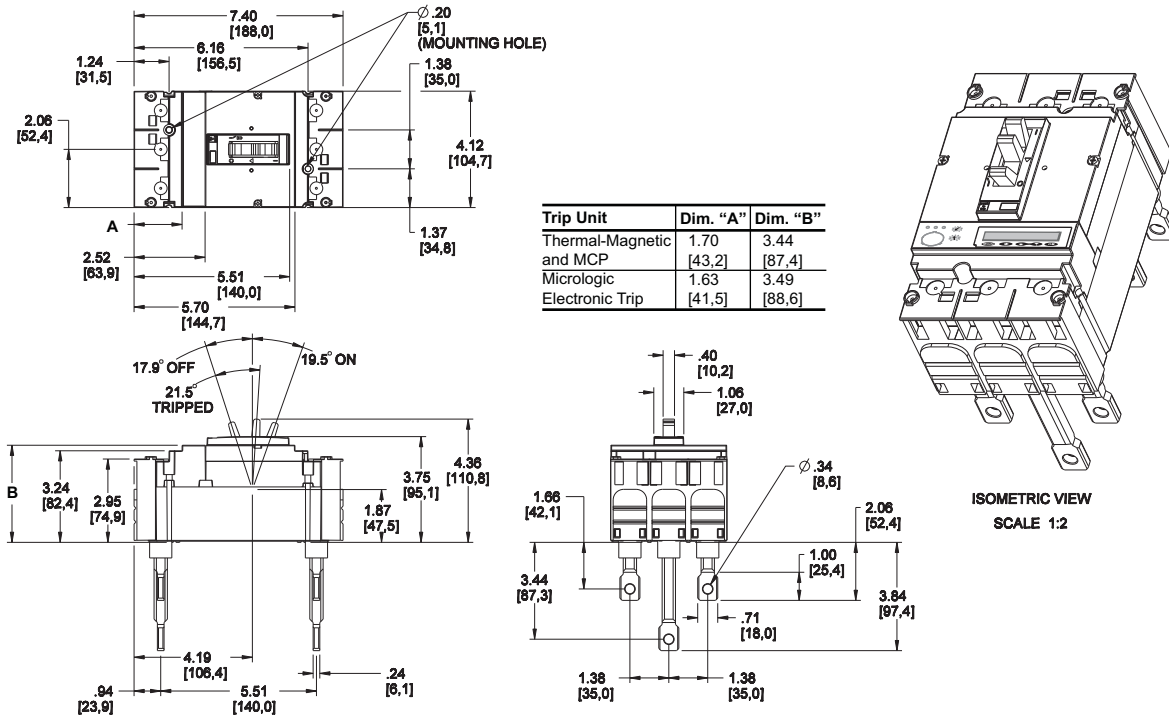
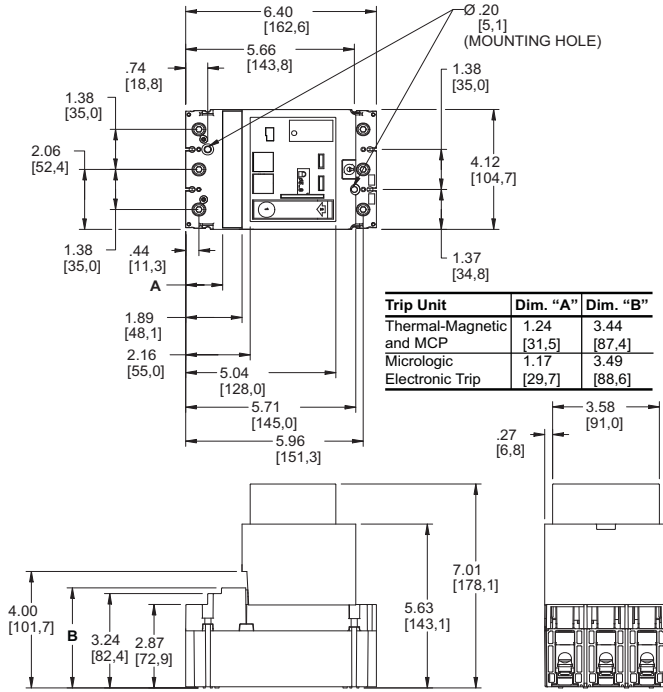

Figure 12: 15–150 A Rear Connected PowerPact H-Frame 3P Circuit Breaker



PowerPact™ H-, J-, and L-Frame Circuit Breakers Dimensions

**Figure 13: Motor Operator Detail
(PowerPact H-Frame Circuit Breaker)**



**Figure 14: Rotary Handle Detail
(PowerPact H-Frame Circuit Breaker)**

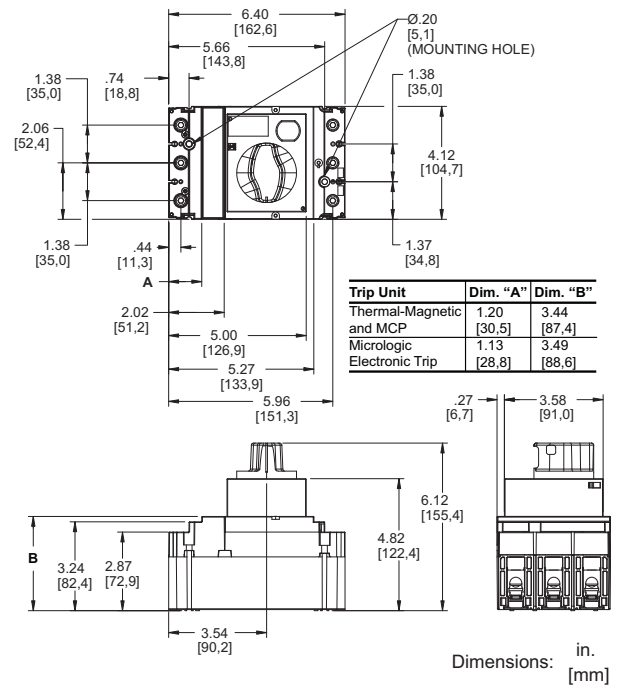

PowerPact™ H-, J-, and L-Frame Circuit Breakers Dimensions

PowerPact J-Frame Circuit Breakers

Figure 15: 150–250 A Bus Bar PowerPact J-Frame 3P Circuit Breaker

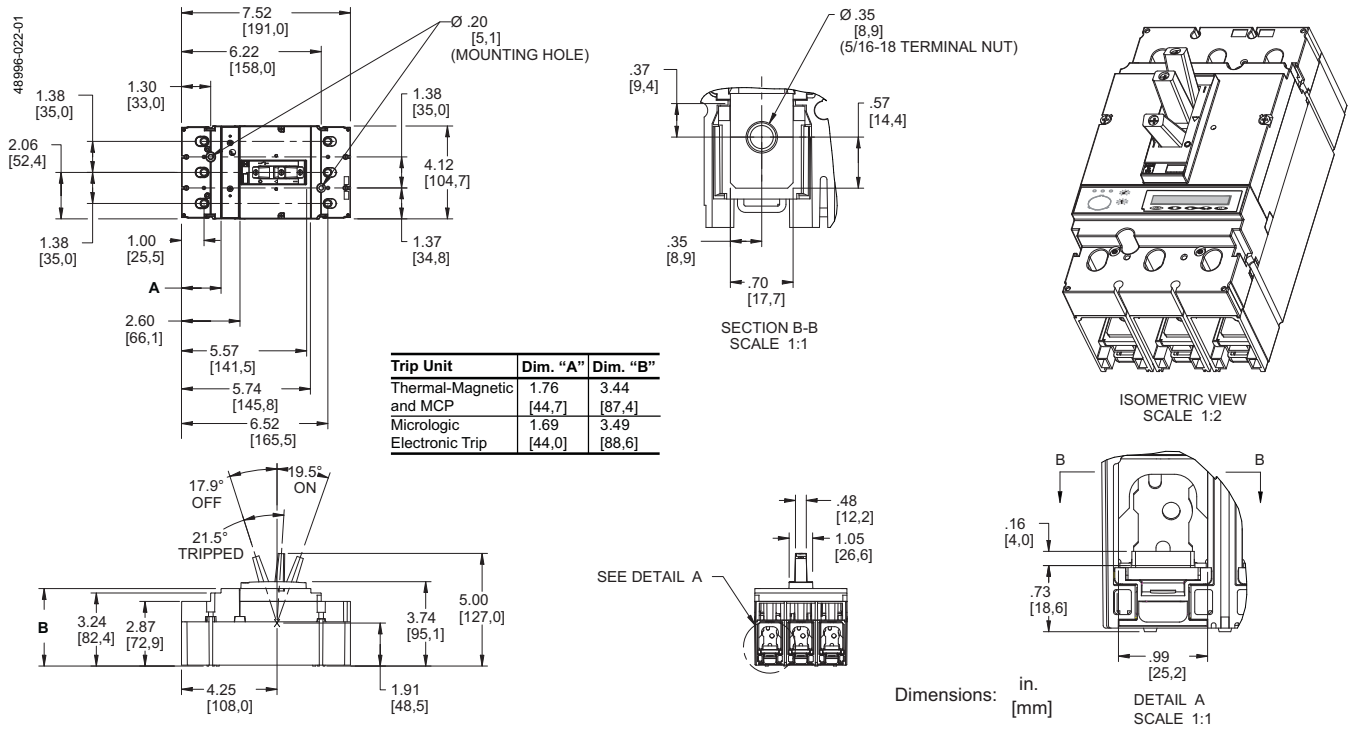
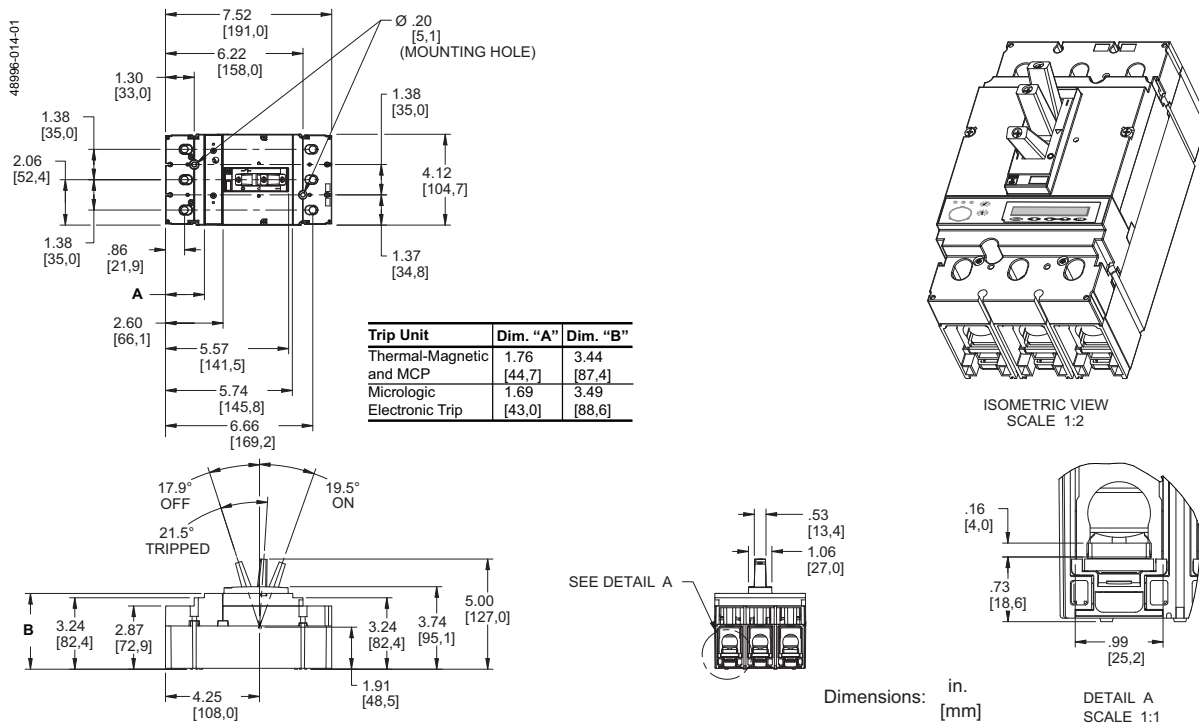

Figure 16: 150–250 A Lug-Lug PowerPact J-Frame 3P Circuit Breaker



PowerPact™ H-, J-, and L-Frame Circuit Breakers Dimensions

PowerPact H- and J-Frame Plug-In Circuit Breakers

Figure 20: 15–250 A PowerPact H- and J-Frame 3P Circuit Breaker Plug-In Base

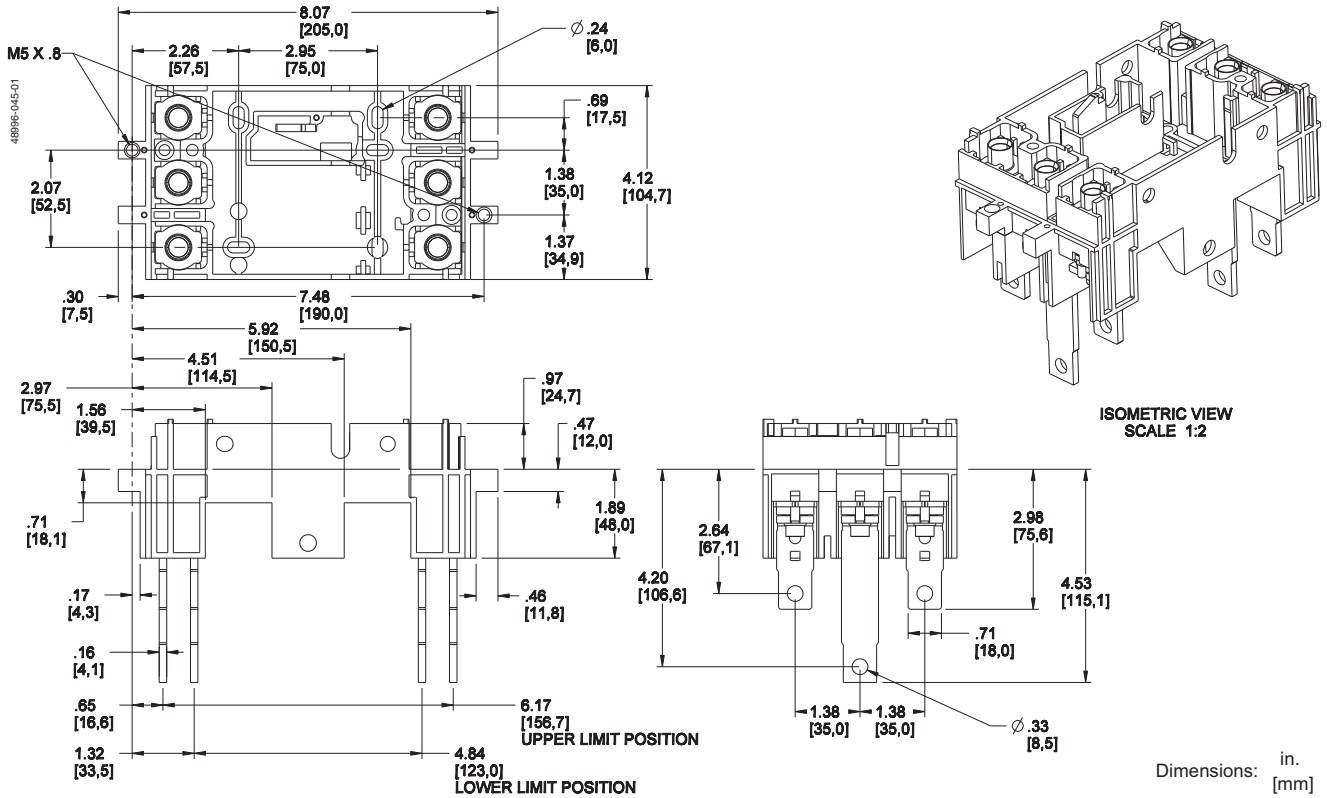
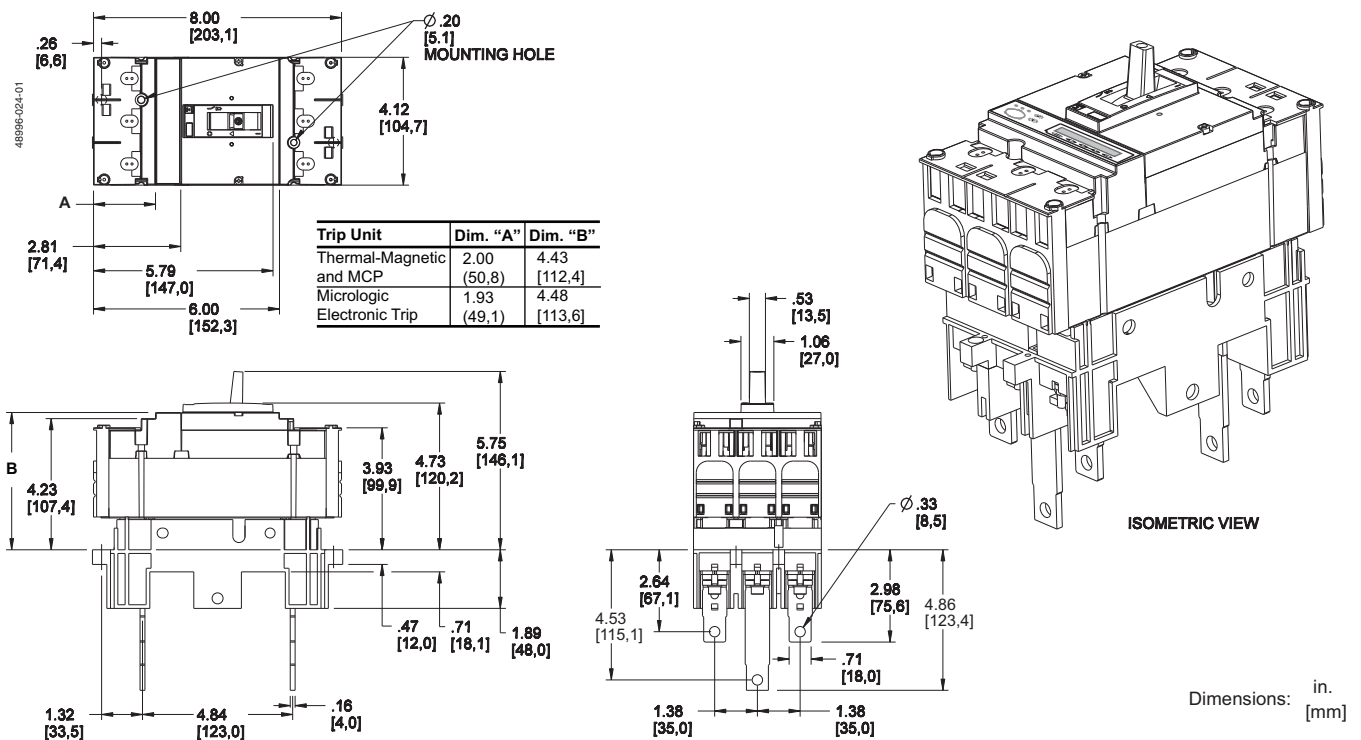

Figure 21: 15–250 A PowerPact H- and J-Frame Plug-In 3P Circuit Breaker



PowerPact™ H-, J-, and L-Frame Circuit Breakers Dimensions

PowerPact H- and J-Frame Drawout Circuit Breakers

Figure 22: 15–250 A PowerPact H- and J-Frame 3P Circuit Breaker Cradle

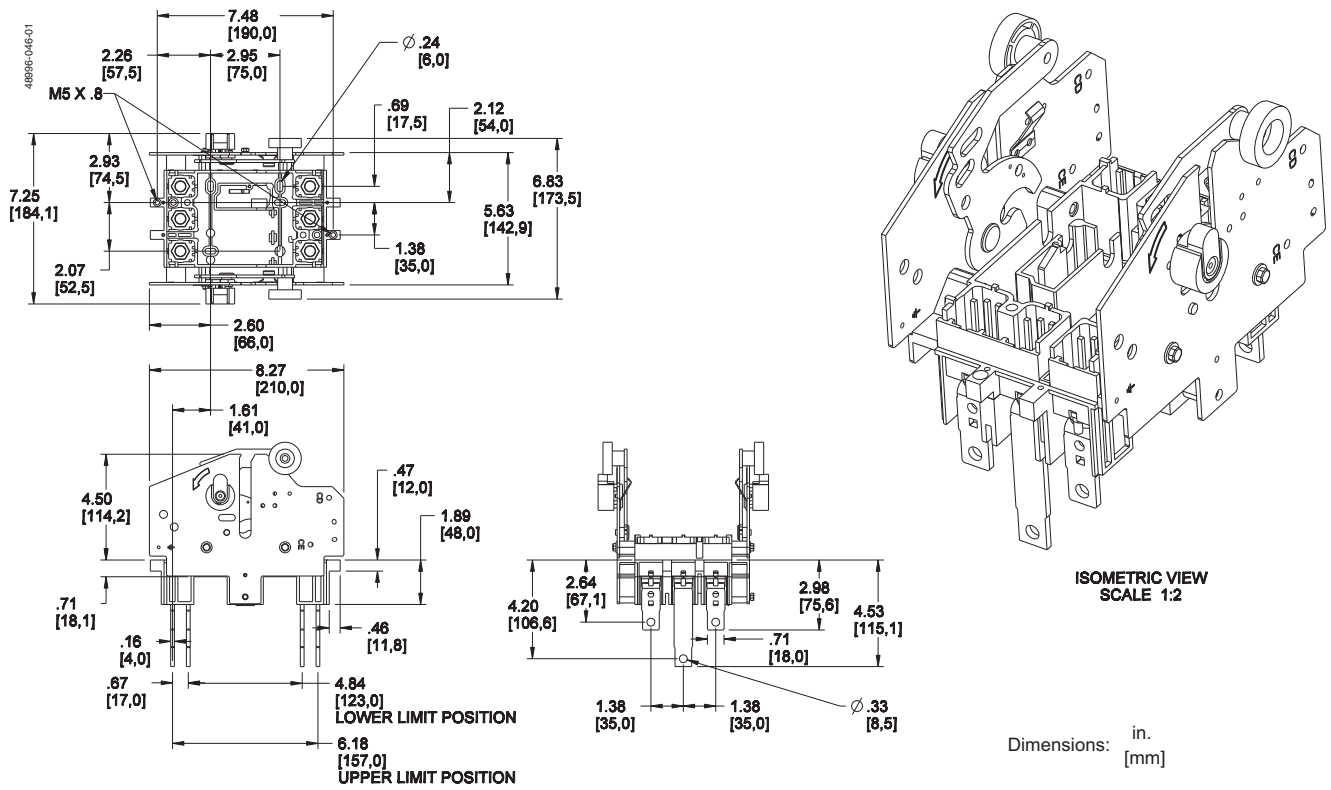
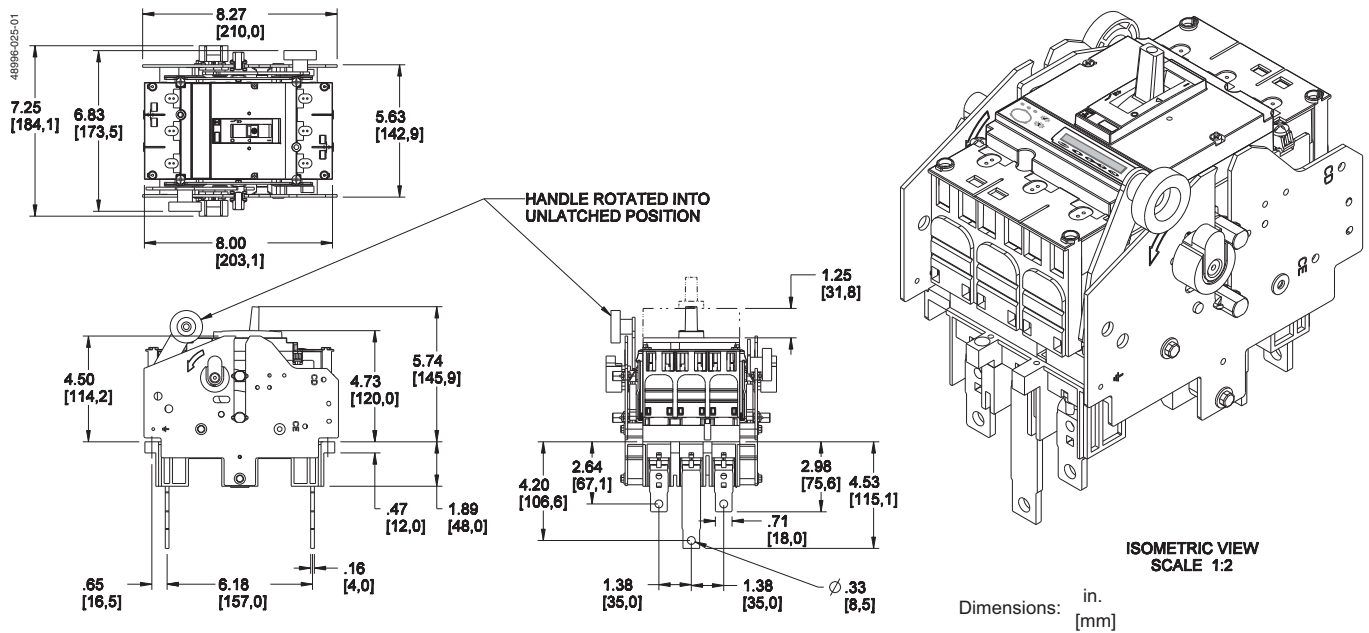

Figure 23: 15–250 A PowerPact H- and J-Frame Drawout 3P Circuit Breaker



PowerPact™ H-, J-, and L-Frame Circuit Breakers Dimensions

PowerPact H- and J-Frame Circuit Breaker Mounting

Figure 24: PowerPact H-Frame 2P HD/HG Thermal-Magnetic Only Circuit Breaker

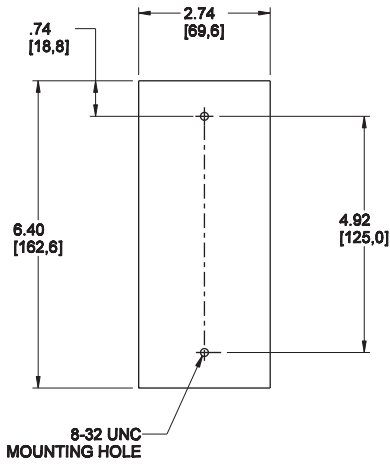

Dimensions: in.
[mm]

Figure 25: PowerPact H- and J-Frame 3P Circuit Breaker

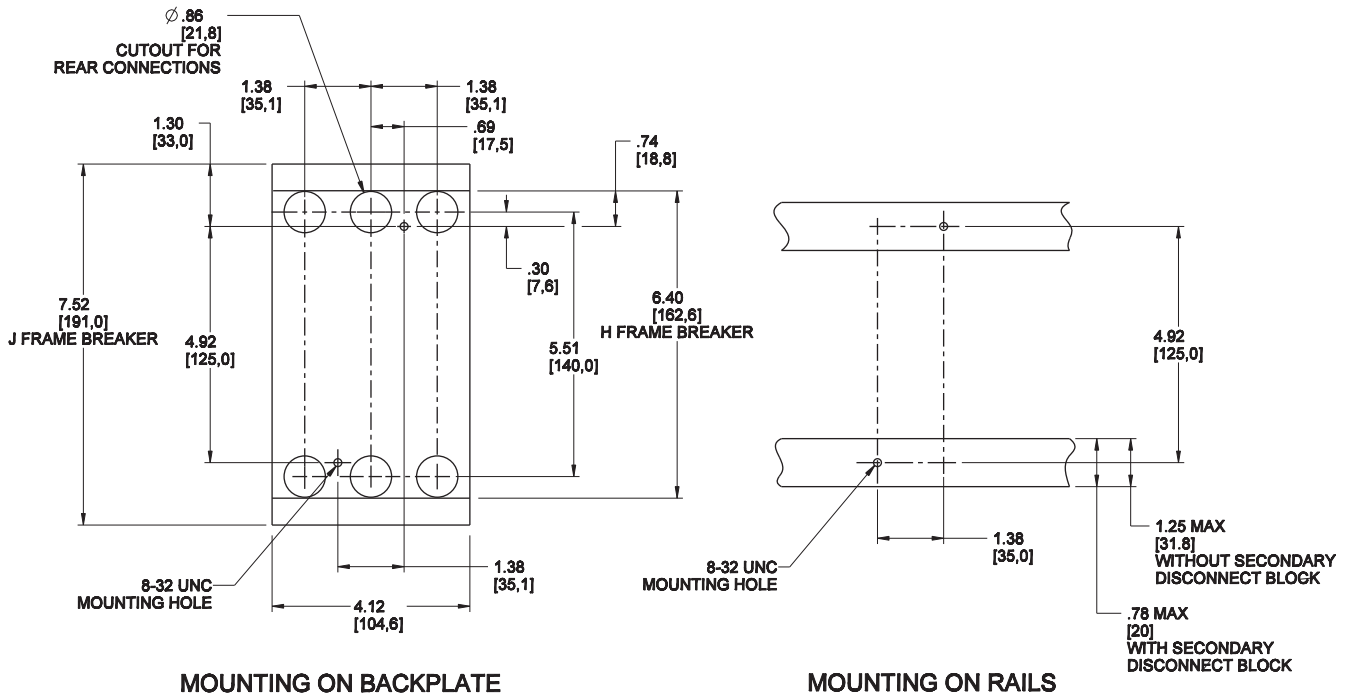

Dimensions: in.
[mm]

PowerPact™ H-, J-, and L-Frame Circuit Breakers Dimensions

PowerPact H- and J-Frame Circuit Breaker Door Cutouts

Figure 26: PowerPact H- and J-Frame Circuit Breaker Toggle Handle Door Cutout

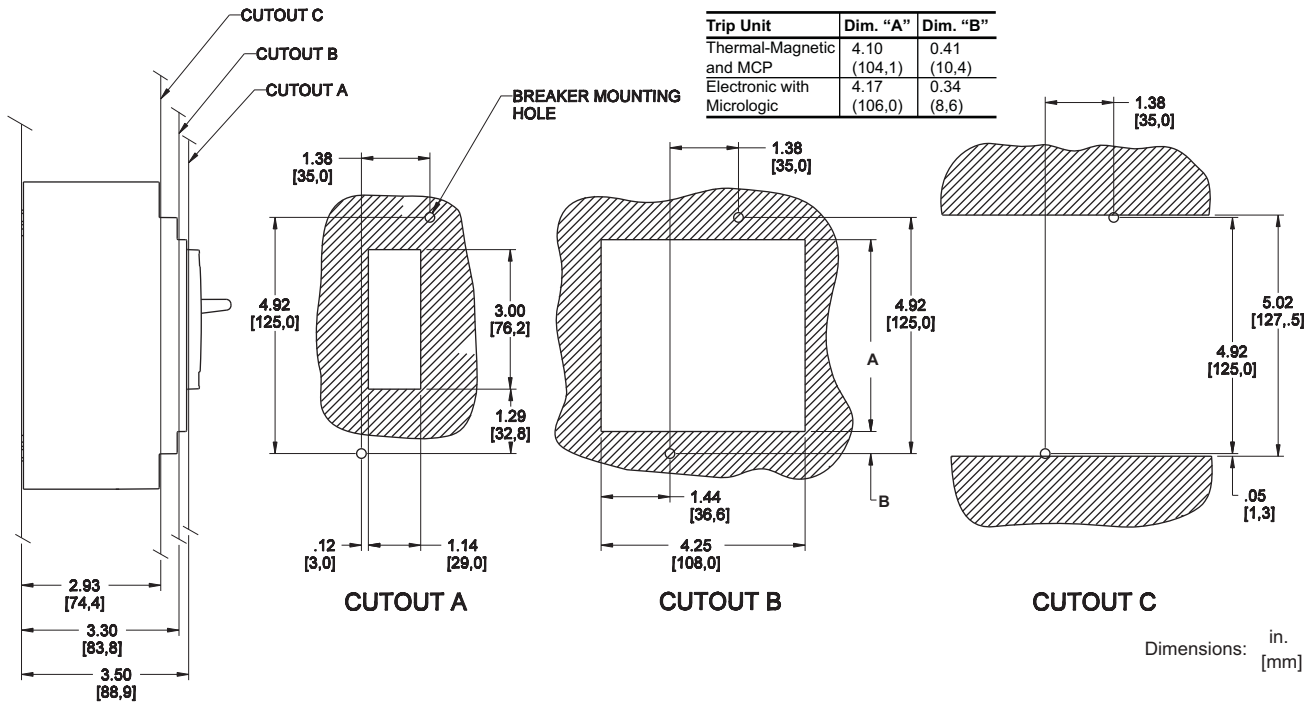
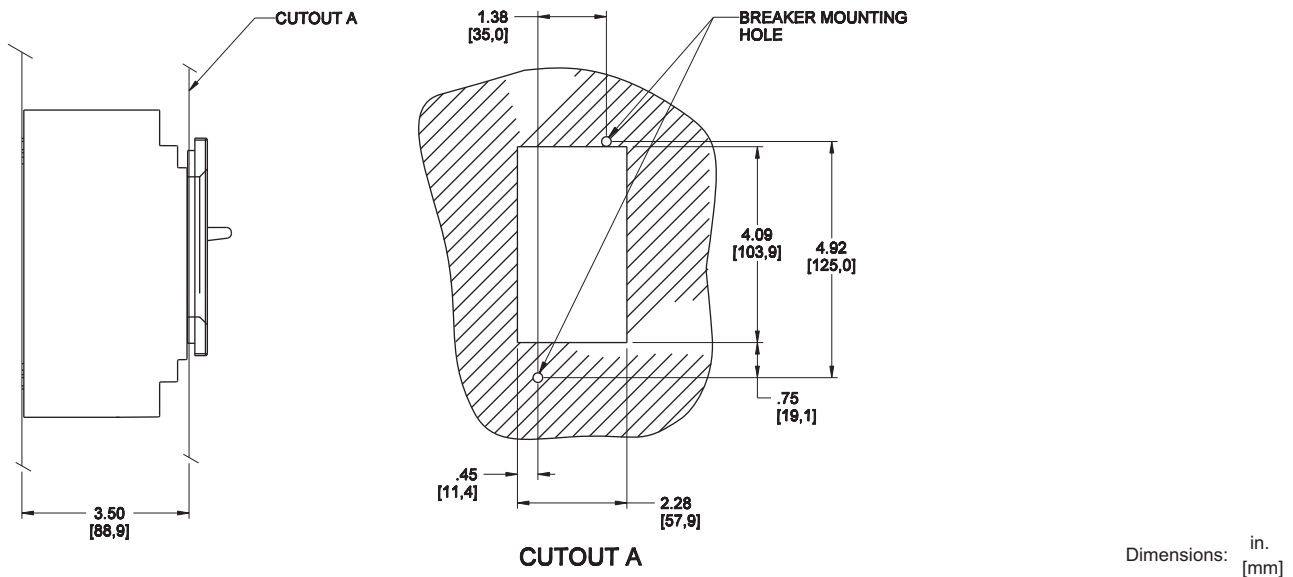

Figure 27: PowerPact H- and J-Frame Circuit Breaker Toggle Handle With Escutcheon Door Cutout



PowerPact™ H-, J-, and L-Frame Circuit Breakers Dimensions

Figure 28: PowerPact H- and J-Frame Circuit Breaker Fixed Rotary Handle Cutout

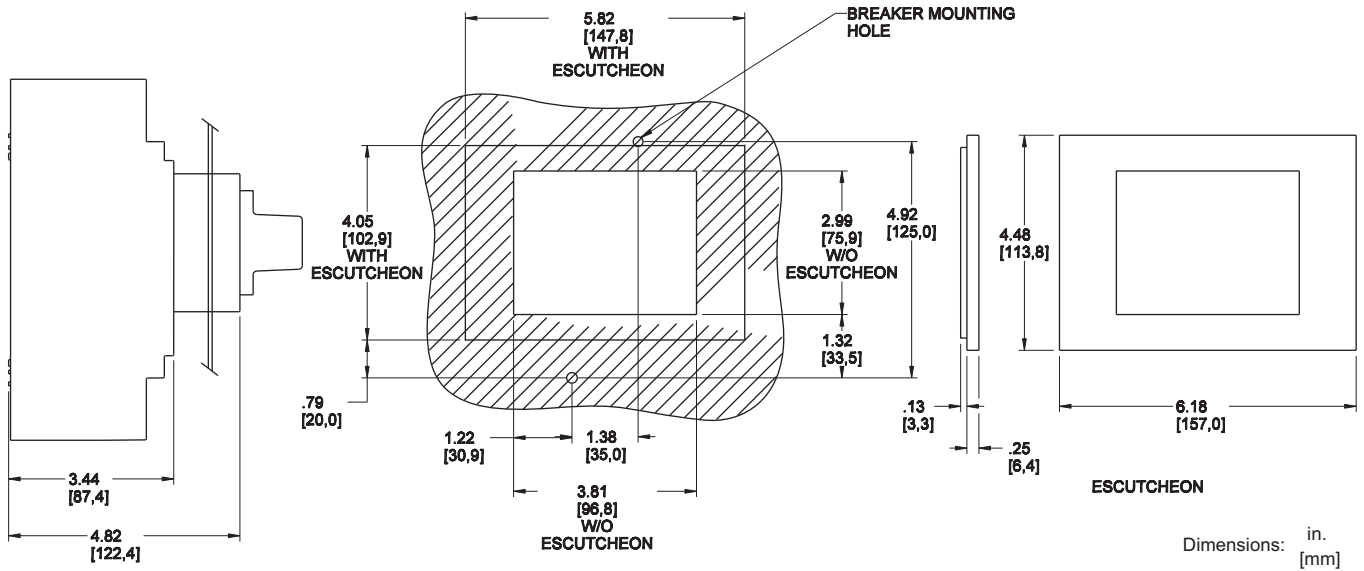
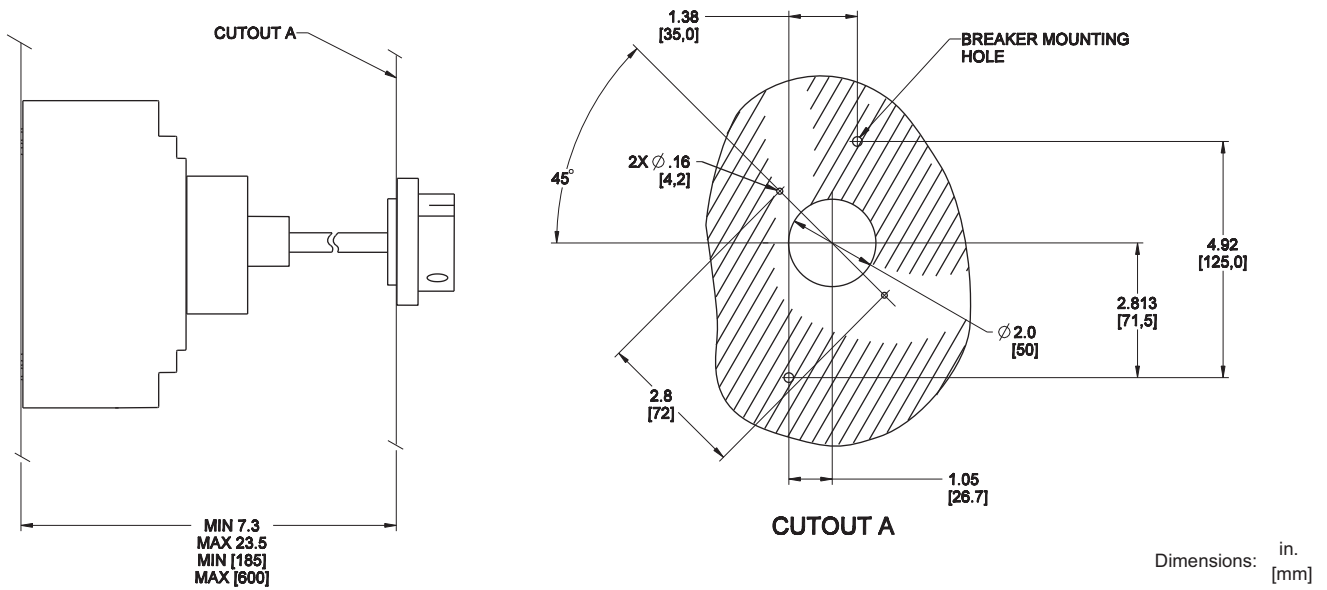
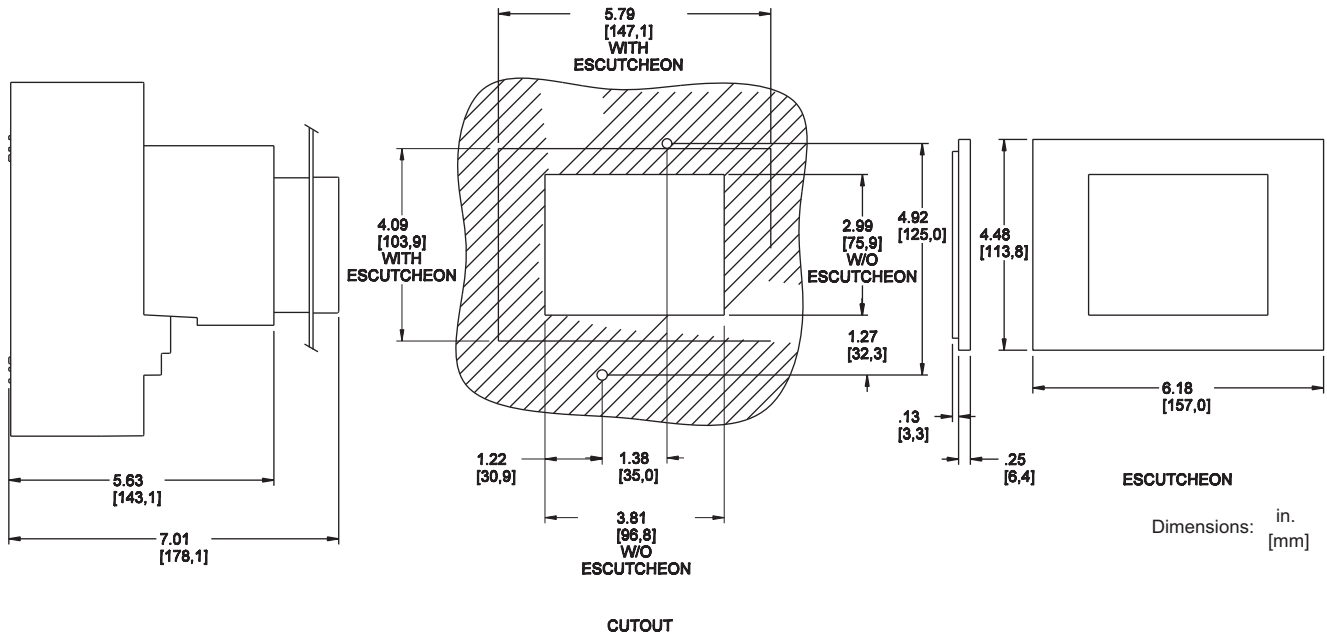

Figure 29: PowerPact H- and J-Frame Circuit Breaker Door Mounted Rotary Handle Cutout



PowerPact™ H-, J-, and L-Frame Circuit Breakers Dimensions

Figure 30: PowerPact H- and J-Frame Circuit Breaker Motor Operator Cutout



PowerPact L-Frame Circuit Breakers

Figure 31: PowerPact L-Frame Fixed Mounted Electronic Trip Circuit Breaker

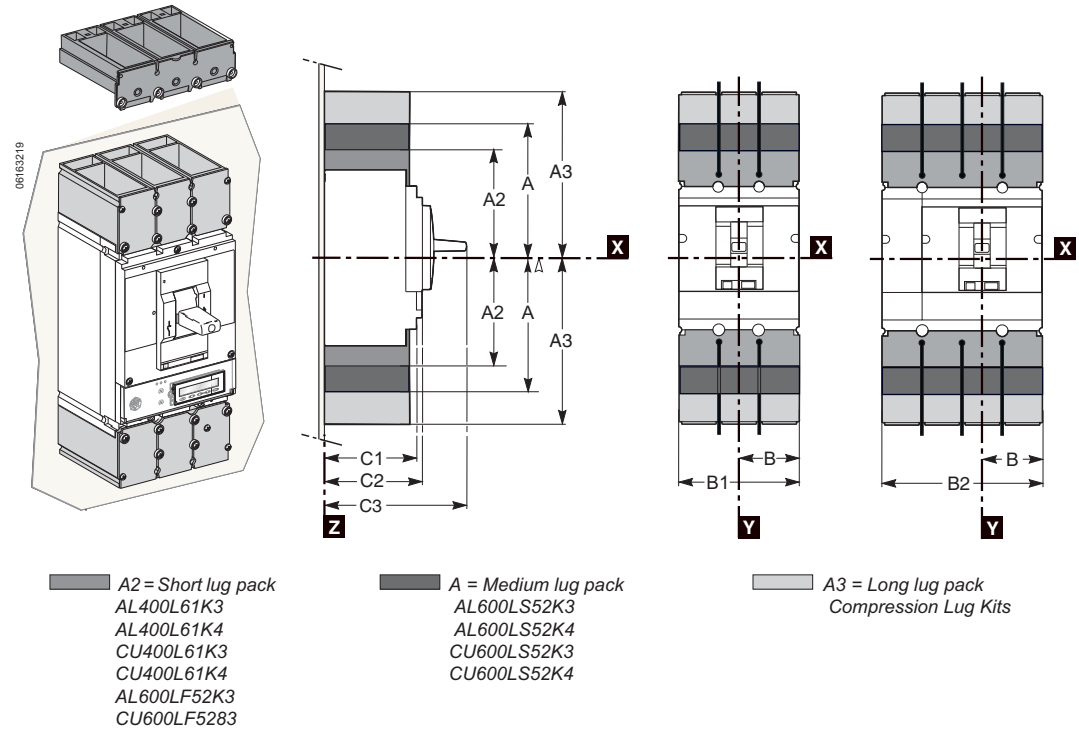

	A	A2	A3	B	B1	B2	C1	C2	C3
inch	6.69	5.65	7.87	2.76	5.51	7.28	3.76	4.33	6.61
mm	170	143.5	200	70	140	185	105	110	168

Figure 32: PowerPact L-Frame Circuit Breaker Mounting

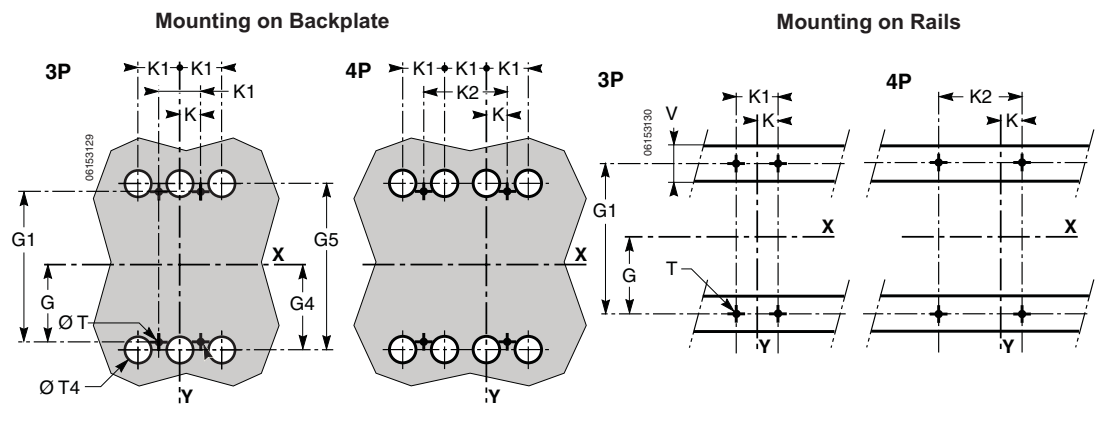

	G	G1	G4	G5	K1	K1	K2	T	T4 ²	U ³
inch	3.93	7.87	4.46	8.93	0.88	1.77	3.54	0.23	1.25	1.38
mm	100	200	113.5	227	22.5	45	90	6	32	35

- For 2 pole circuit breaker, the middle holes are not required.
- For rear connected circuit breakers only.
- V is ≤ 78 in. (20 mm) on C-frame circuit breakers with secondary disconnecting blocks.

PowerPact™ H-, J-, and L-Frame Circuit Breakers Dimensions

Figure 33: Front Panel Cutouts for PowerPact L-Frame Fixed or Plug-In Circuit Breakers

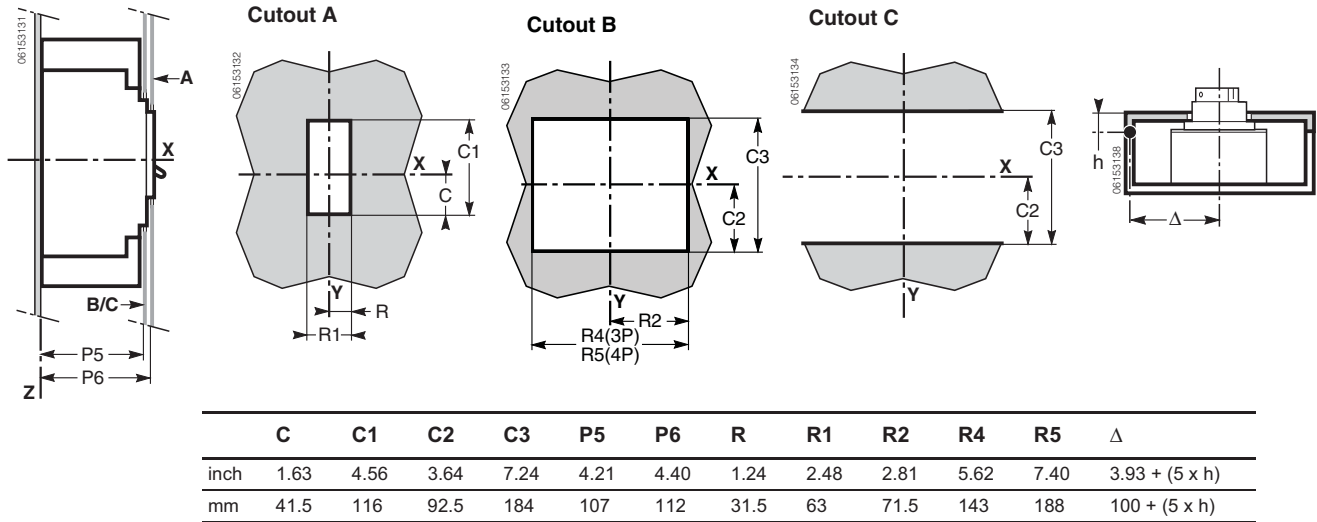
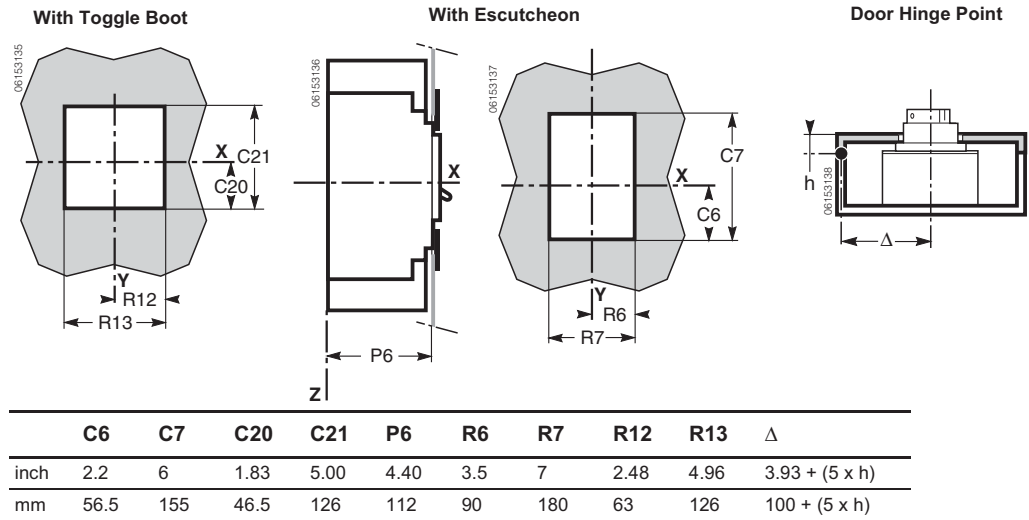

Figure 34: PowerPact L-Frame Circuit Breaker Front Panel Cutouts for Toggle Boot and Escutcheon



PowerPact™ H-, J-, and L-Frame Circuit Breakers Dimensions

PowerPact L-Frame Plug-In and Drawout Mounting

Figure 35: PowerPact L-Frame Plug-In Circuit Breaker (On Base)

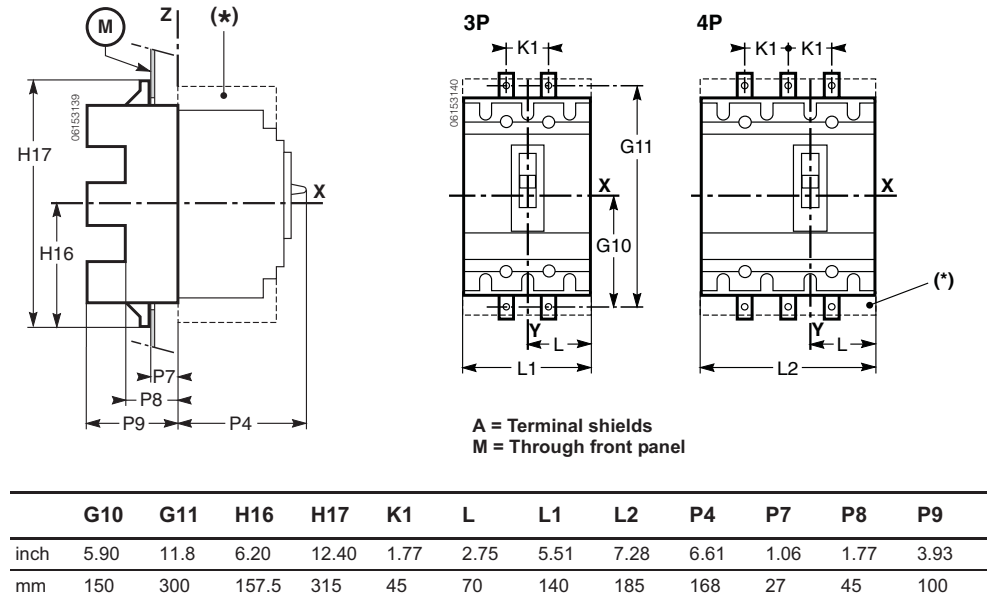
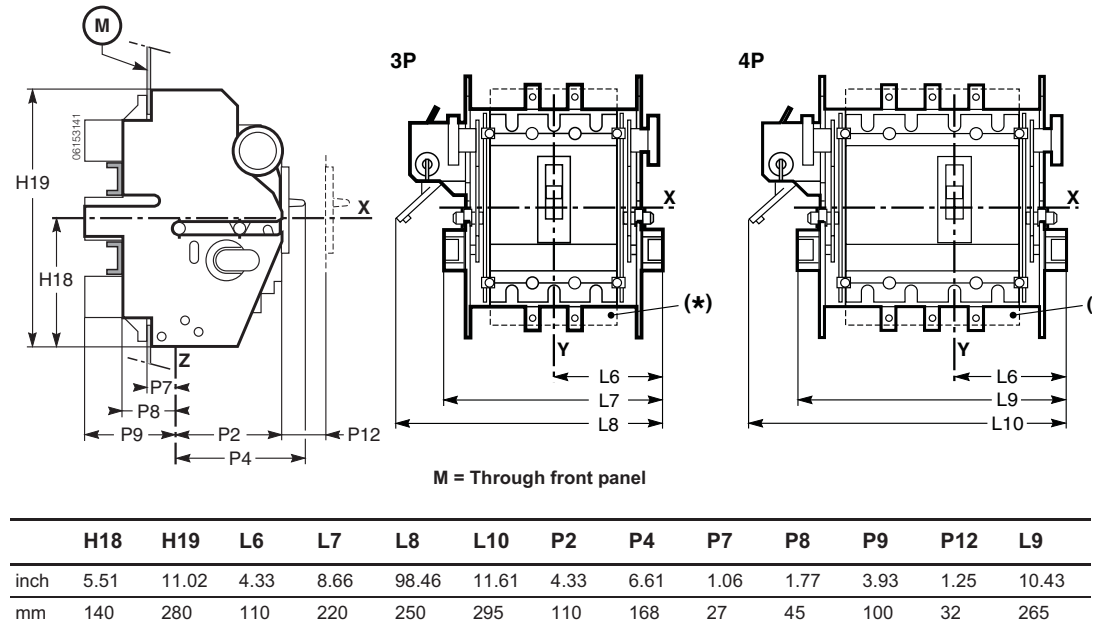

Figure 36: PowerPact L-Frame Drawout Circuit Breaker (on Cradle)



PowerPact™ H-, J-, and L-Frame Circuit Breakers Dimensions

Figure 37: PowerPact L-Frame Circuit Breaker Mounting Through a Backplate

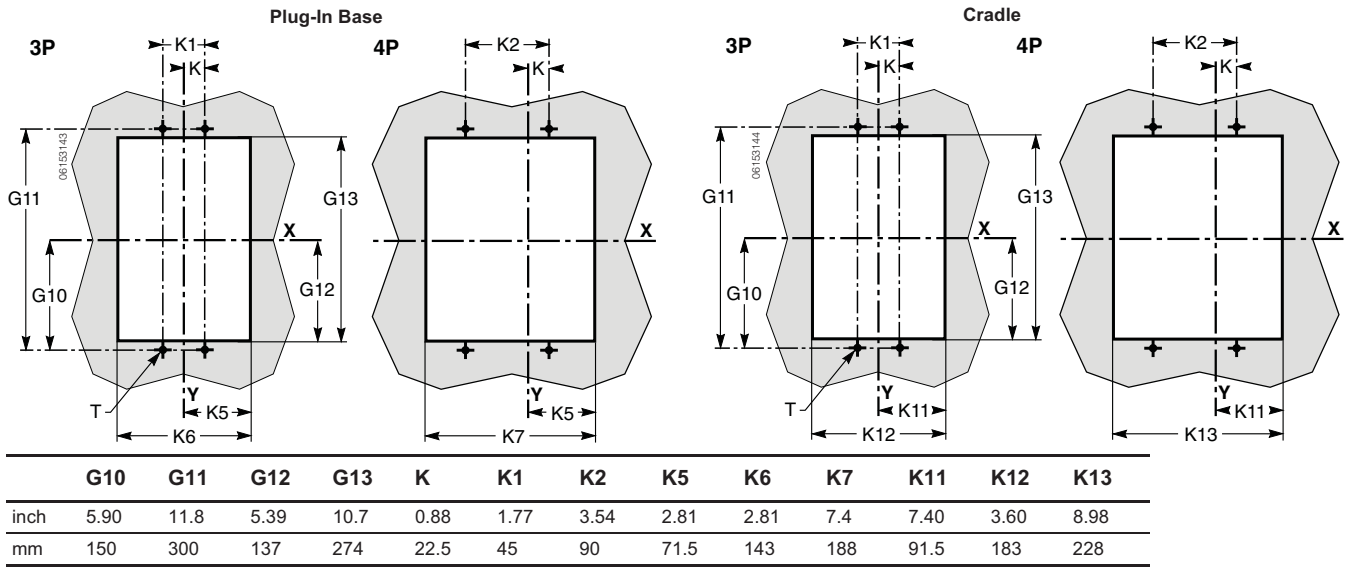

Figure 38: PowerPact L-Frame Circuit Breaker Mounting on Rails (Plug-In Base or Cradle)

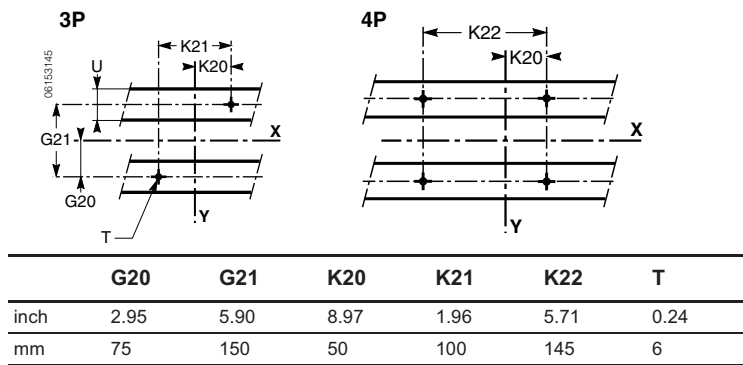
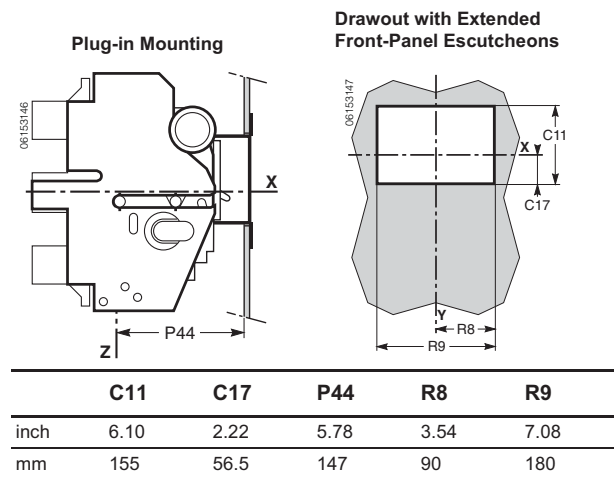

Figure 39: PowerPact L-Frame Circuit Breaker Front-Panel Cutouts



PowerPact™ H-, J-, and L-Frame Circuit Breakers Dimensions

PowerPact L-Frame Circuit Breaker Handles and Handle Operators

Figure 40: PowerPact L-Frame Circuit Breaker Motor Operators

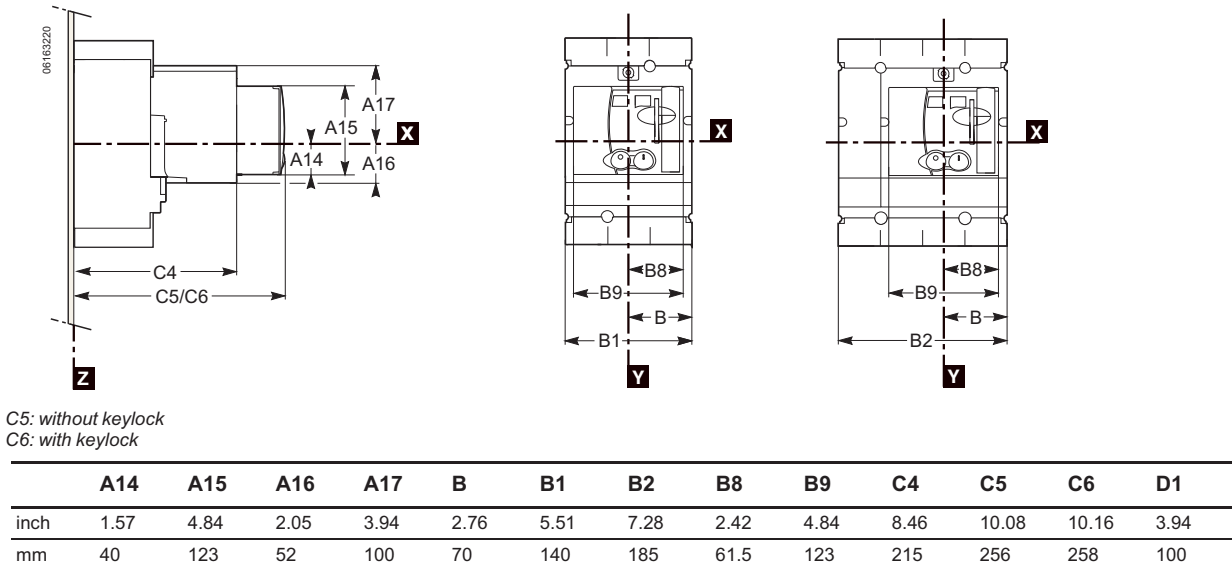
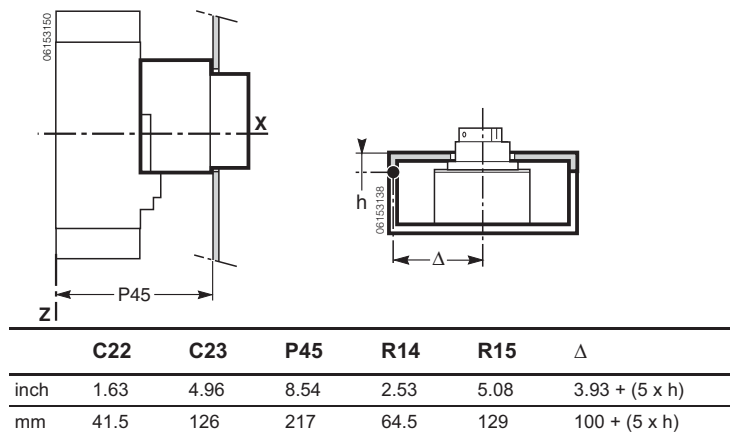

Figure 41: PowerPact L-Frame Circuit Breaker Motor Operator Front-Panel Cutouts



PowerPact™ H-, J-, and L-Frame Circuit Breakers Dimensions

Figure 42: PowerPact L-Frame Circuit Breaker Cable-Operating Handles

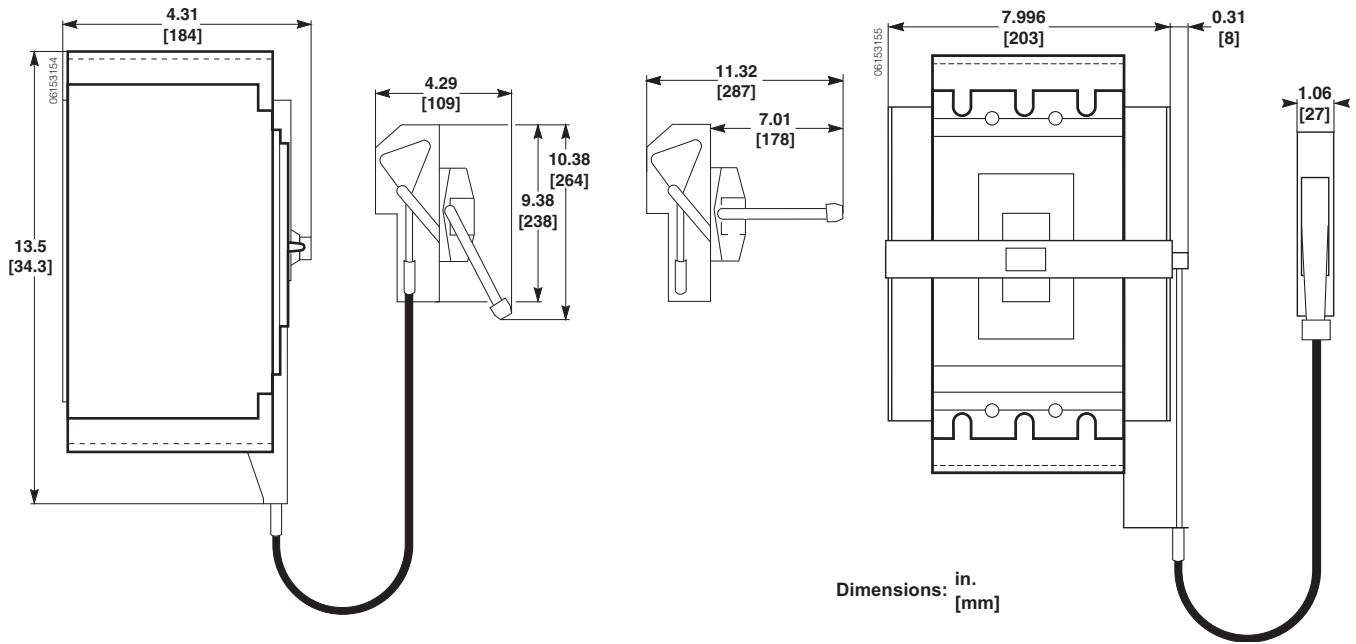
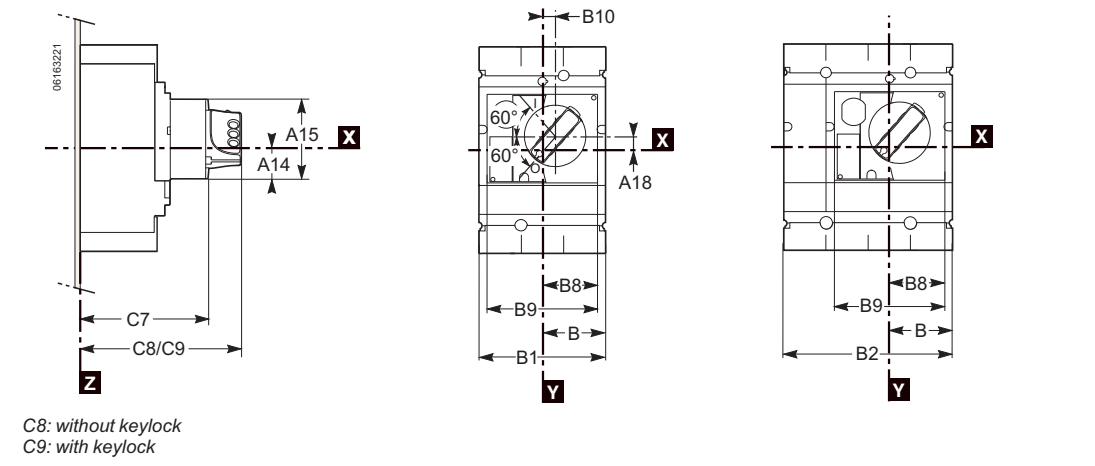

Figure 43: PowerPact L-Frame Circuit Breaker Rotary-Operating Handles



	A14	A15	A18	B	B1	B2	B8	B9	B10	C7	C8	C9	D1
inch	1.57	4.84	0.97	2.76	5.51	7.28	2.42	4.84	0.20	5.71	7.05	7.40	3.94
mm	40	123	24.6	70	140	185	61.5	123	5	145	179	188	100

PowerPact™ H-, J-, and L-Frame Circuit Breakers Dimensions

Figure 44: PowerPact L-Frame Motor-Control Center Circuit Breaker Direct Rotary-Operating Handle

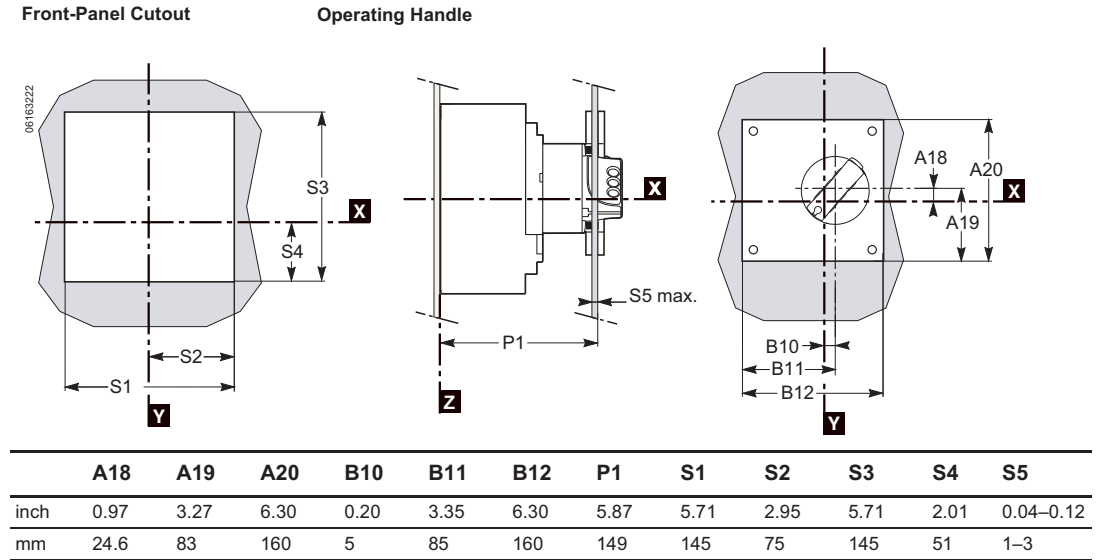
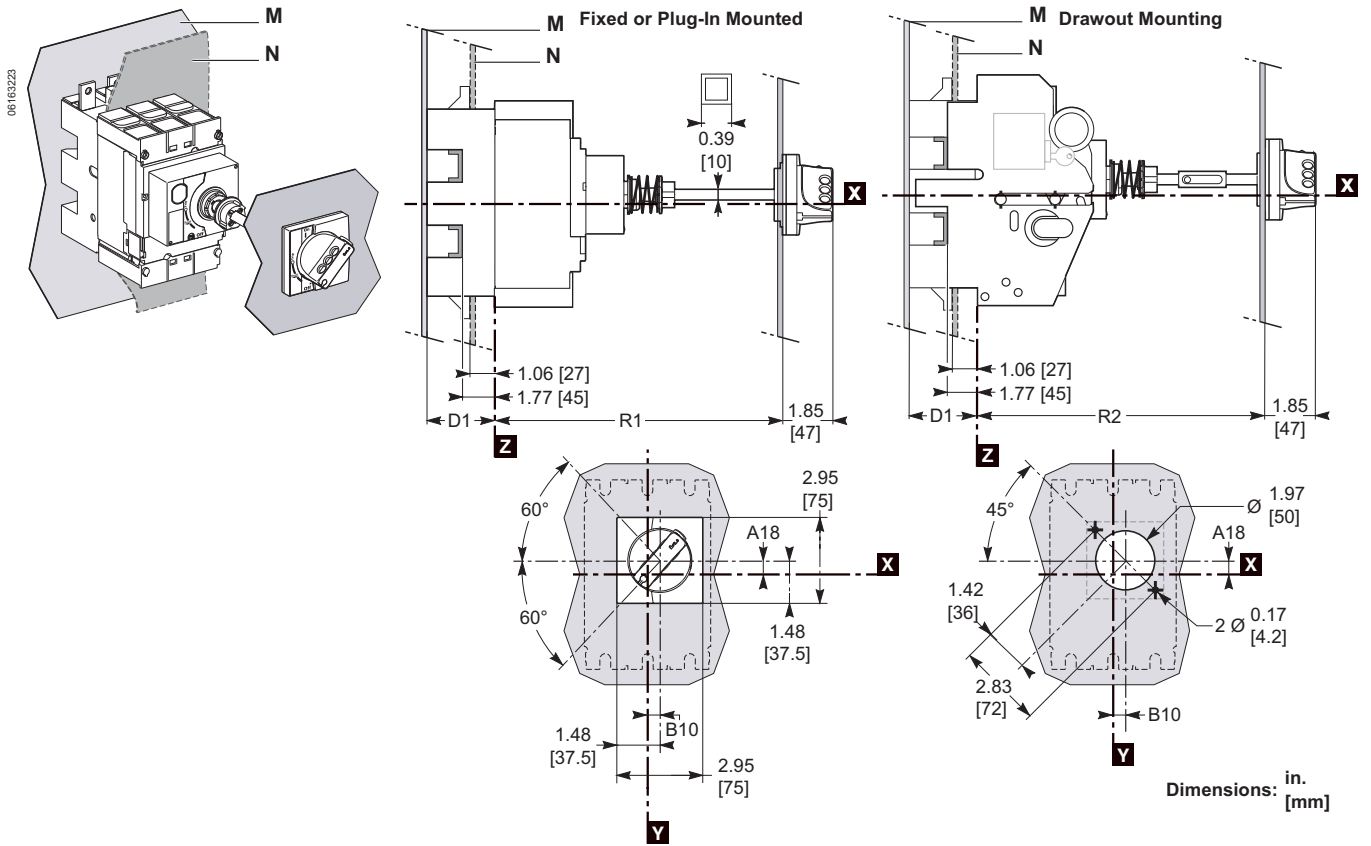

Figure 45: PowerPact L-Frame Circuit Breaker Extended Rotary Handle Mounting



	R1 min	R1 max	R2 min	R2 max	A18	B10	D1
inch	7.68	23.62	10.71	23.62	0.97	0.20	3.94
mm	195	600	272	600	24.6	5	100

PowerPact™ H-, J-, and L-Frame Circuit Breakers Dimensions

L-Frame Circuit Breaker Front Accessories

Figure 46: PowerPact L-Frame Circuit Breaker Extended Escutcheons

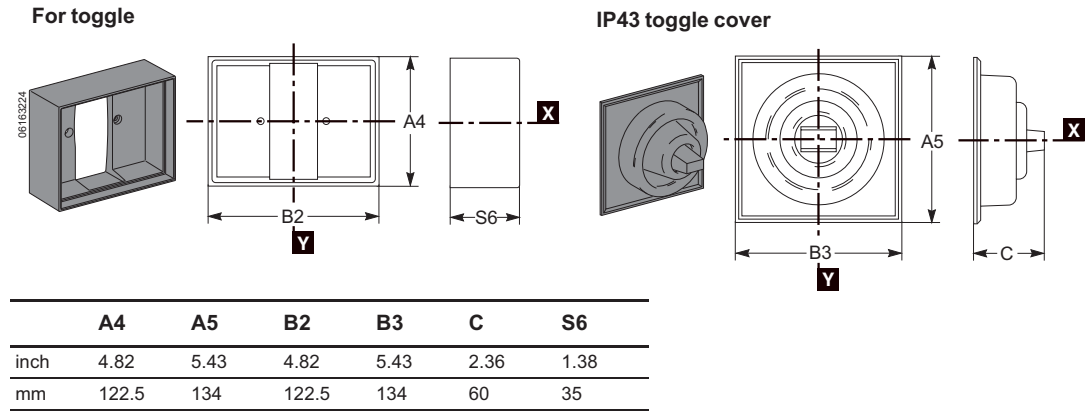
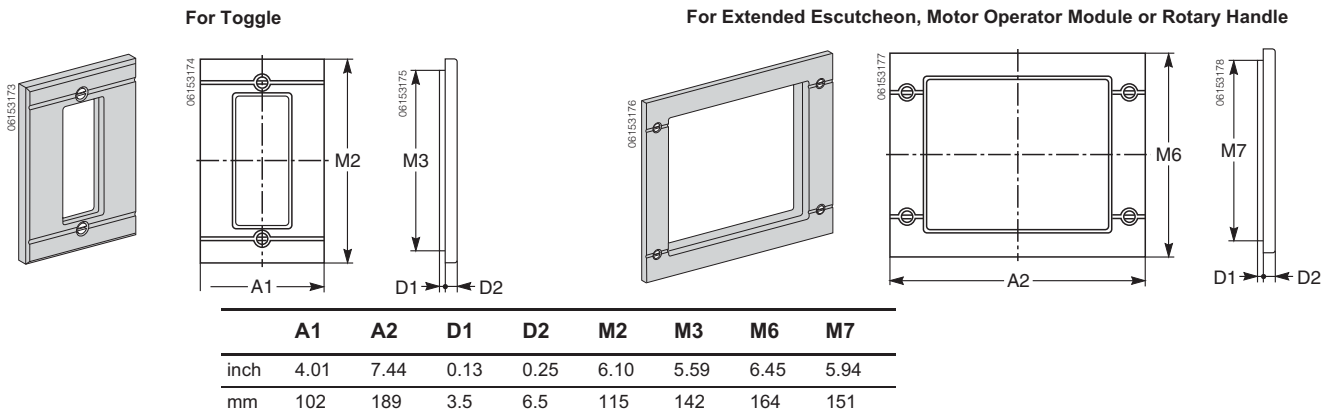
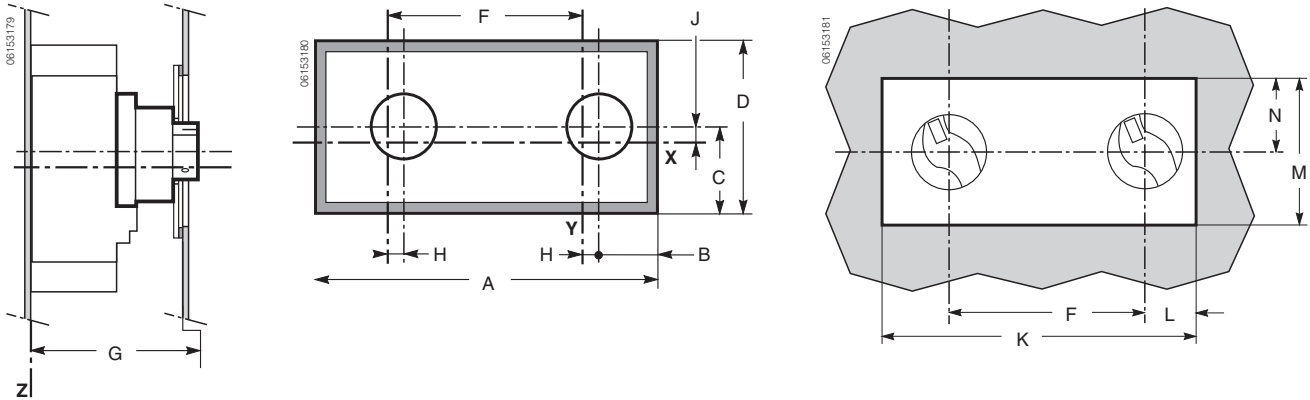

Figure 47: PowerPact L-Frame Circuit Breaker Front-Panel Escutcheons



PowerPact L-Frame Circuit Breaker Interlocking Systems

Figure 48: PowerPact L-Frame Circuit Breaker Interlocking Systems with Rotary-Operating Handles



	A	B	C	D	F	G	H	J	K	L	M	N
inch	16.38	4.53	3.94	7.87	8.27	6.18	0.20	0.97	15.20	3.94	6.89	2.93
mm	416	115	100	200	210	157	5	24.6	386	100	175	74.5

Figure 49: PowerPact L-Frame Circuit Breaker Interlocking Systems with Toggle Handles

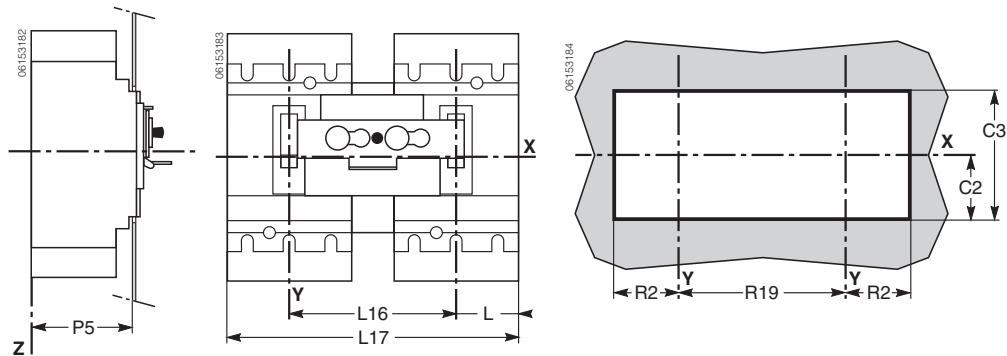

	C2	C3	L	L16	L17	R2	R19	P5
inch	3.64	7.24	2.75	7.28	12.79	2.81	7.28	4.21
mm	92.5	184	70	185	325	71.5	185	107

PowerPact™ H-, J-, and L-Frame Circuit Breakers Dimensions

PowerPact L-Frame Circuit Breaker Connectors

Figure 50: PowerPact L-Frame Circuit Breaker Fixed-Mounted Connections

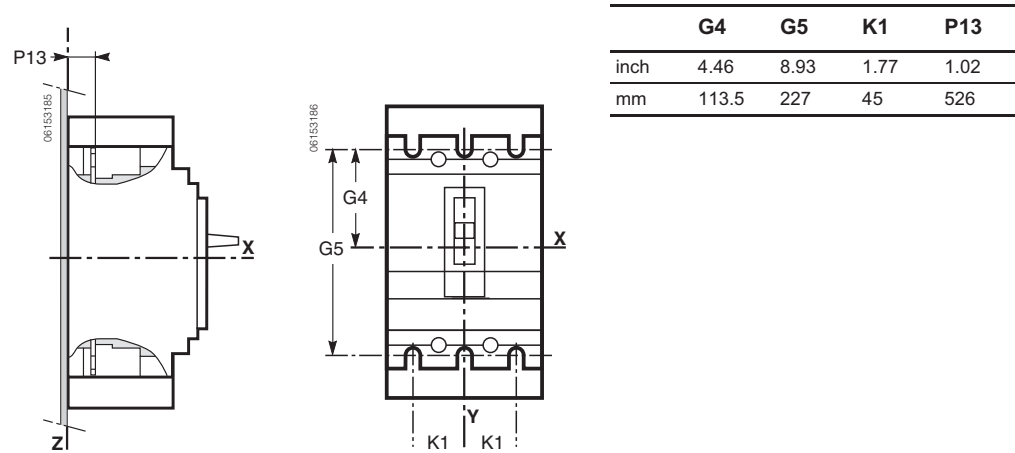

Figure 51: PowerPact L-Frame Circuit Breaker Front Connections

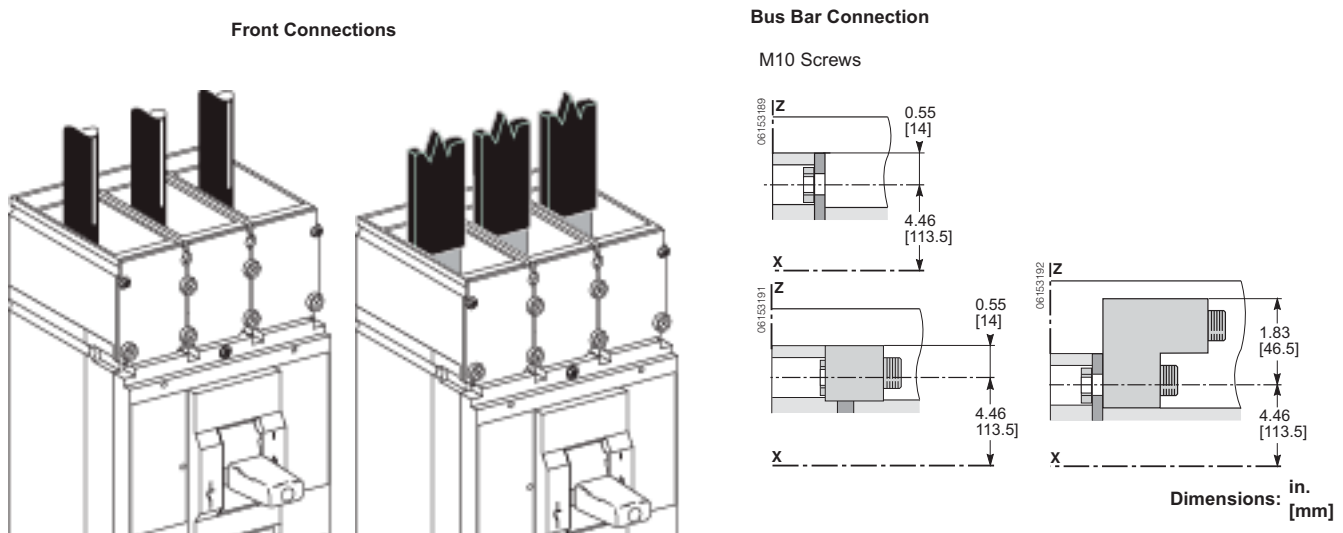
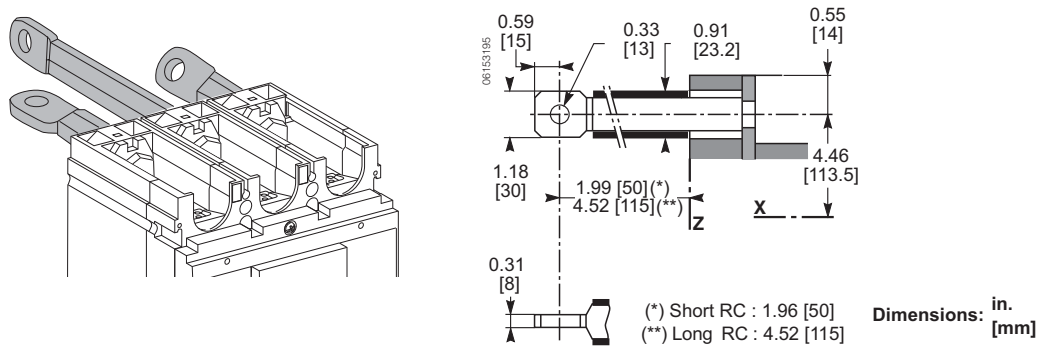

Figure 52: PowerPact L-Frame Circuit Breaker Rear Connections



PowerPact™ H-, J-, and L-Frame Circuit Breakers Dimensions

Figure 53: PowerPact L-Frame Circuit Breaker Plug-In or Drawout Mounting Connections

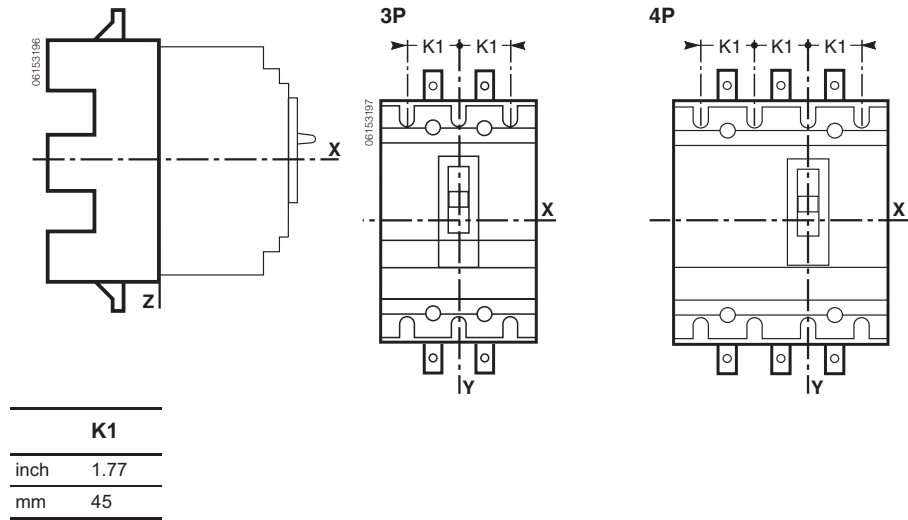

Figure 54: PowerPact L-Frame Circuit Breaker Rear Connections Fitted at Lower Limit

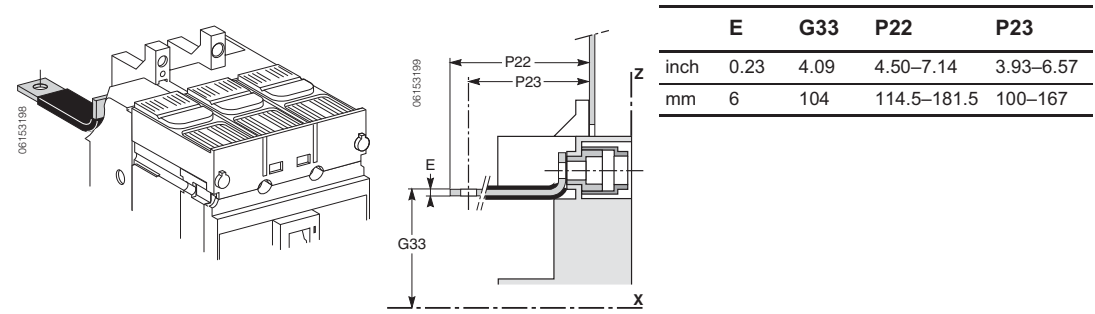
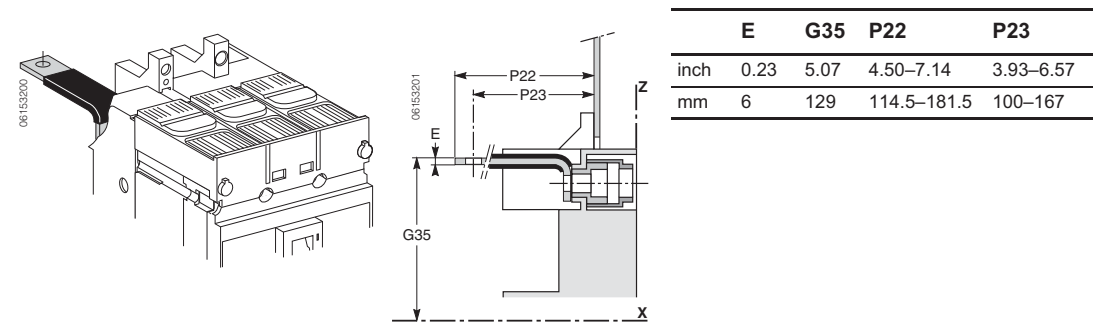

Figure 55: PowerPact L-Frame Circuit Breaker Rear Connections Fitted at Upper Limit



PowerPact™ H-, J-, and L-Frame Circuit Breakers Trip Curves

Section 13—Trip Curves

PowerPact H- and J-Frame Thermal-Magnetic Trip Circuit Breakers

Figure 56: H-Frame 15–35 A (HD, HG, HJ, and HL) Thermal-Magnetic Trip

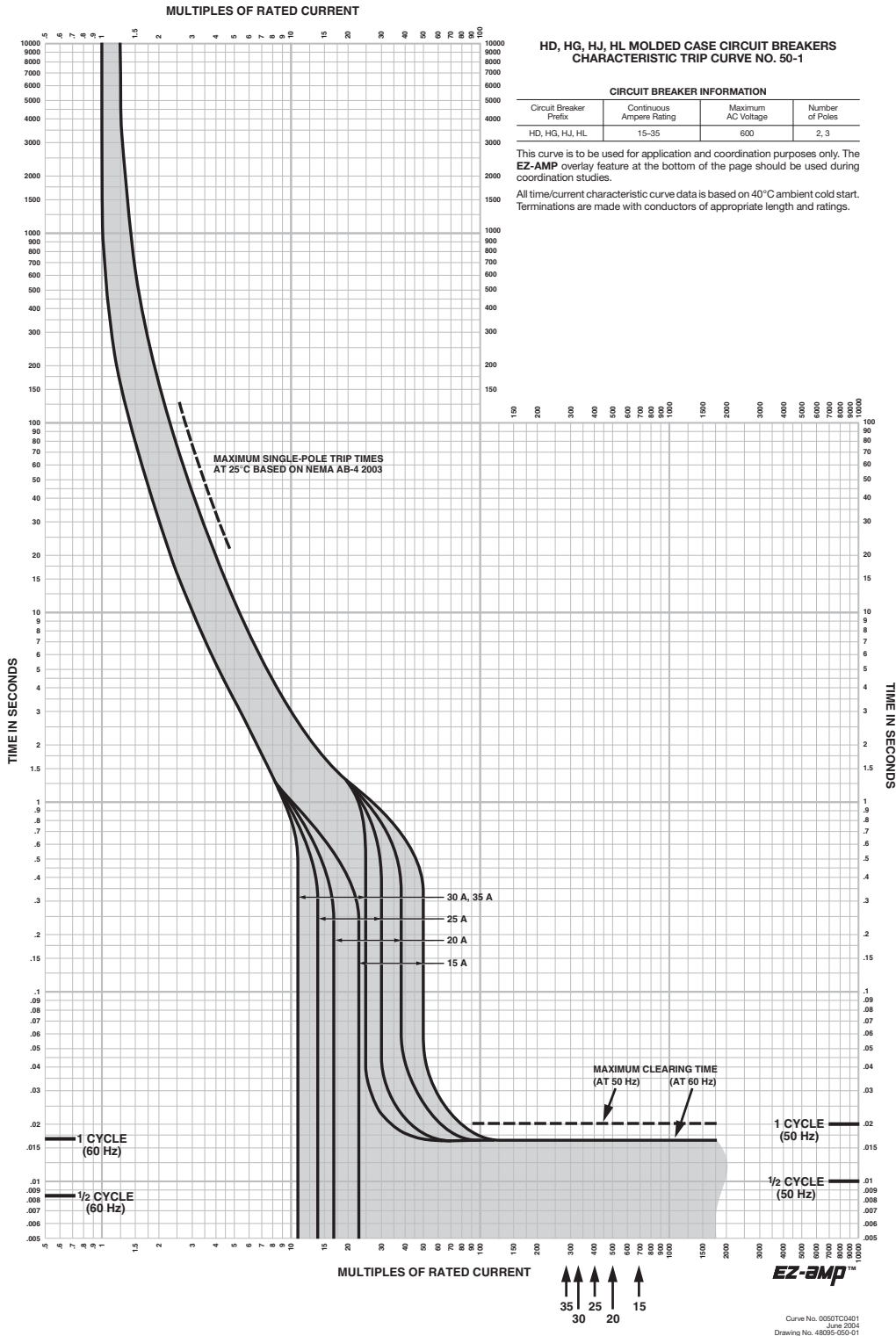

PowerPact™ H-, J-, and L-Frame Circuit Breakers Trip Curves

Figure 57: H-Frame 40–60 A (HD, HG, HJ, and HL) Thermal-Magnetic Trip

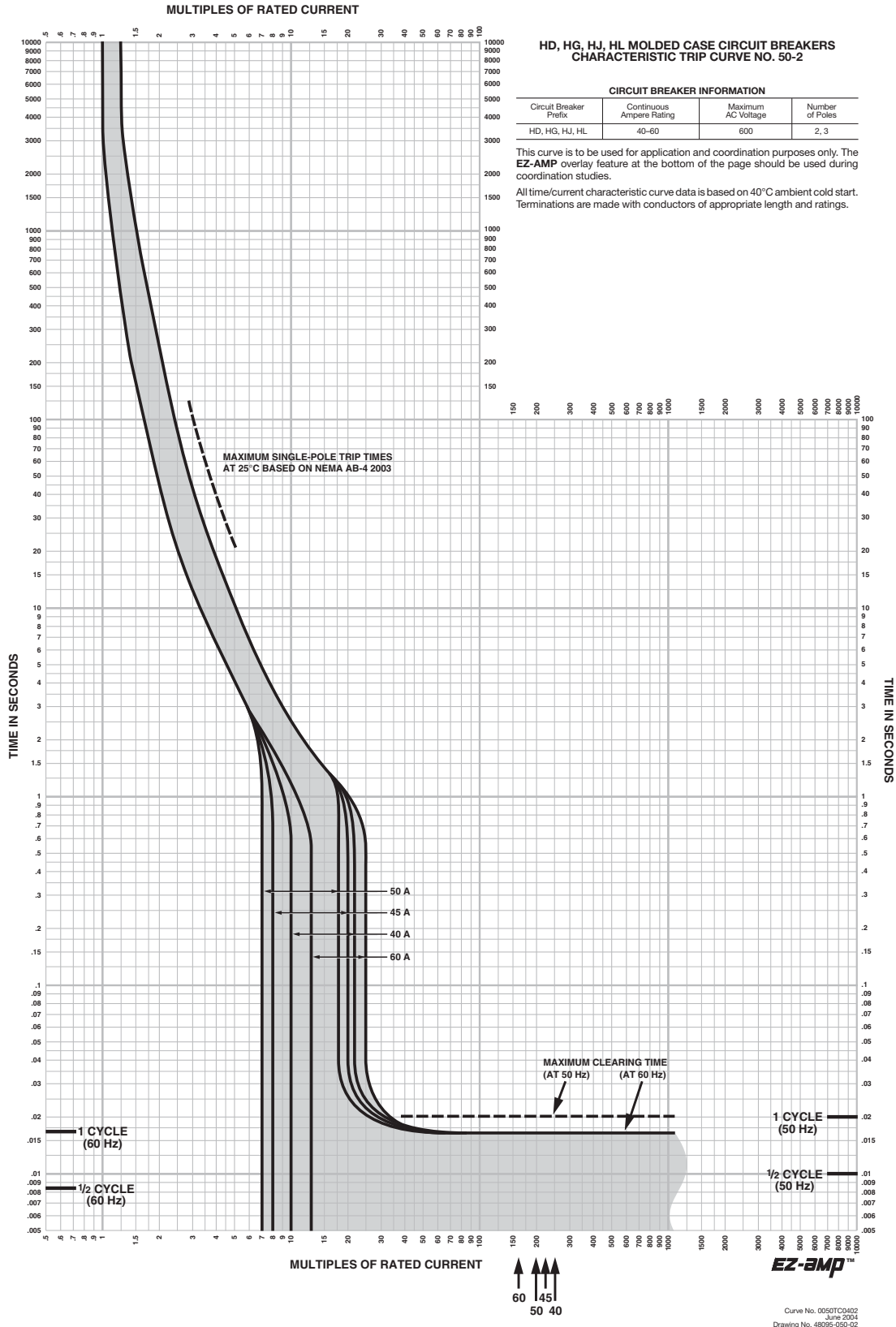

PowerPact™ H-, J-, and L-Frame Circuit Breakers Trip Curves

Figure 58: H-Frame 70–100 A (HD, HG, HJ, and HL) Thermal-Magnetic Trip

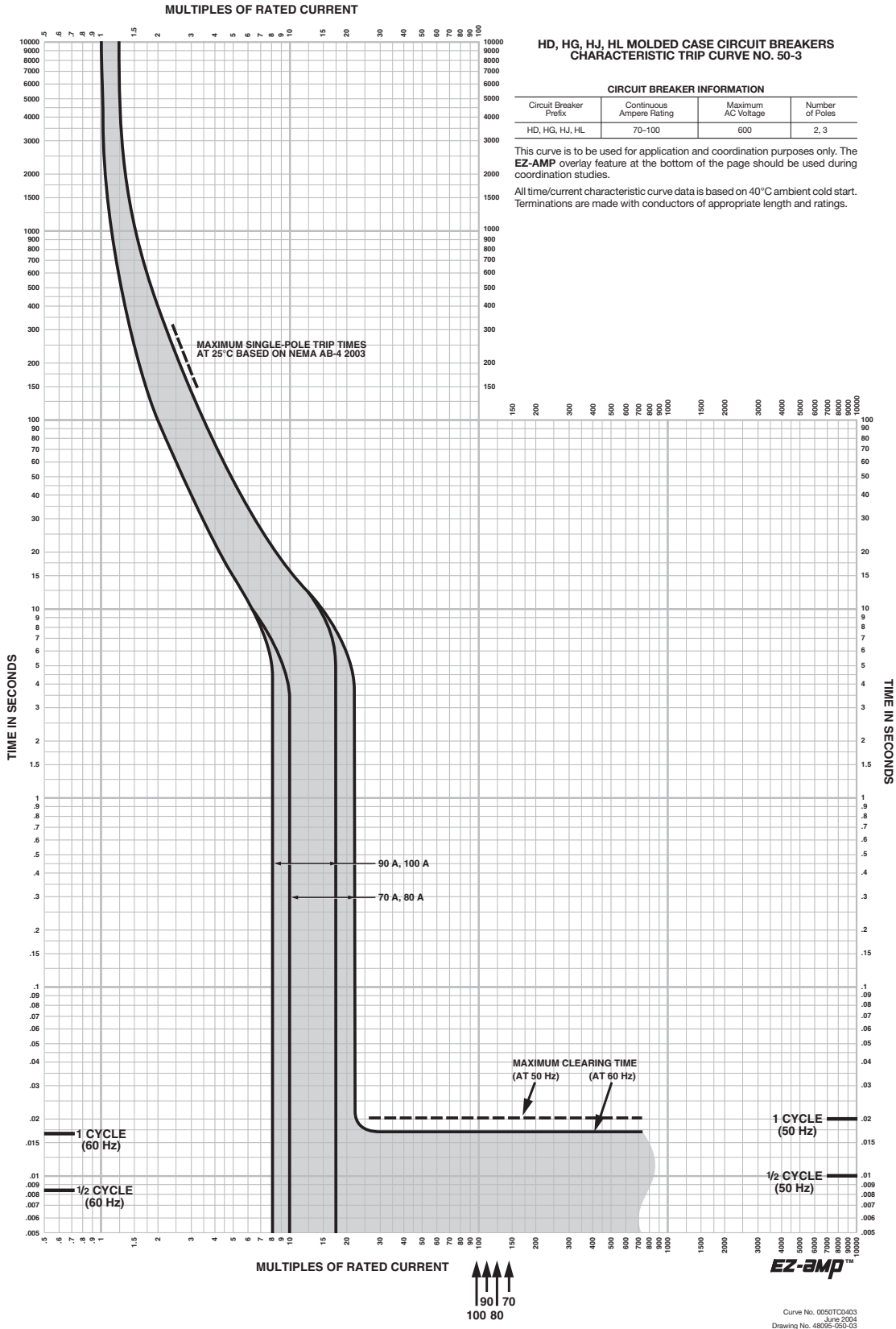

PowerPact™ H-, J-, and L-Frame Circuit Breakers Trip Curves

Figure 59: H-Frame 110–150 A (HD, HG, HJ, and HL) Thermal-Magnetic Trip

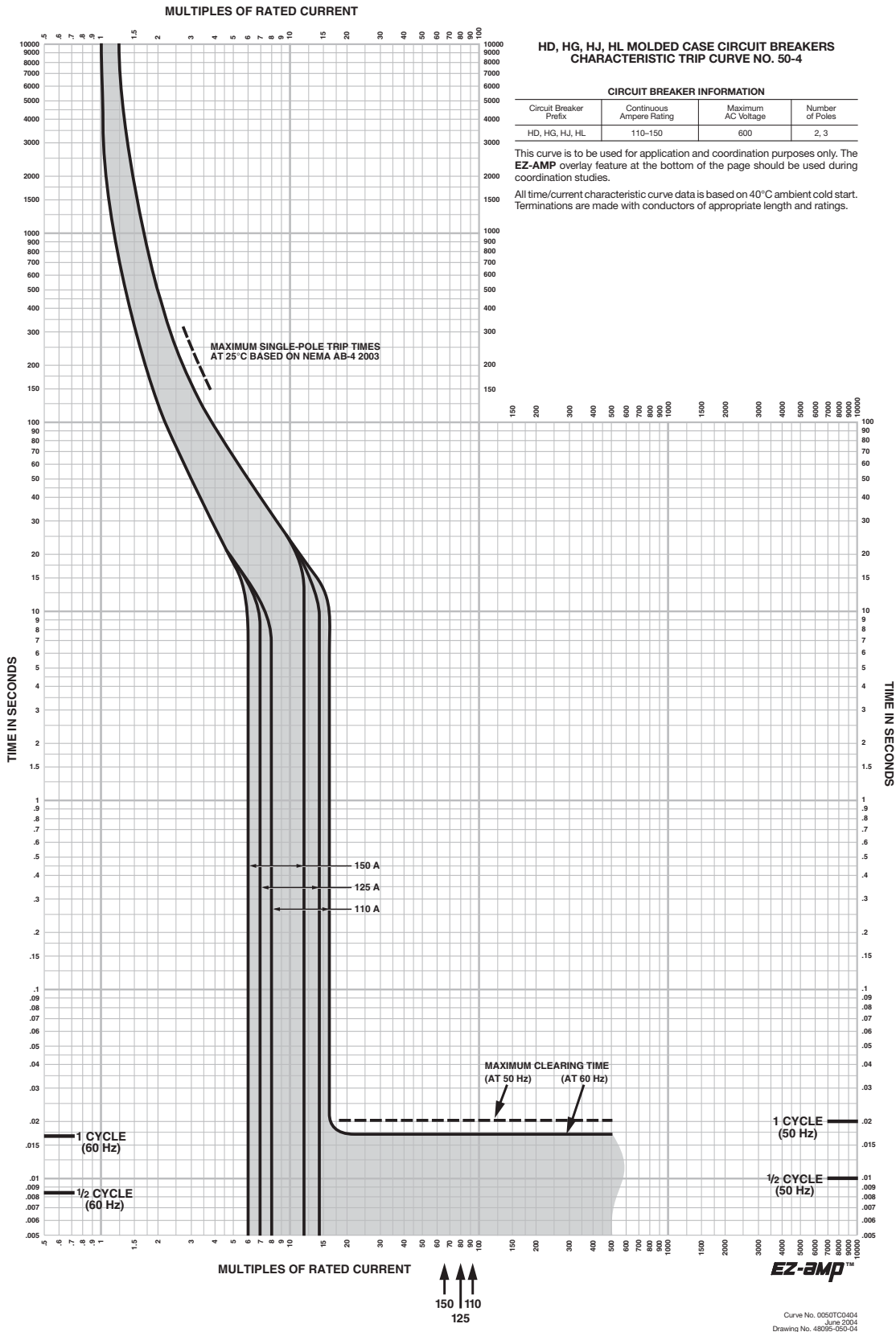

PowerPact™ H-, J-, and L-Frame Circuit Breakers Trip Curves

Figure 60: J-Frame 150–250 A (JD, JG, JJ, JL, and JR) Thermal-Magnetic Trip

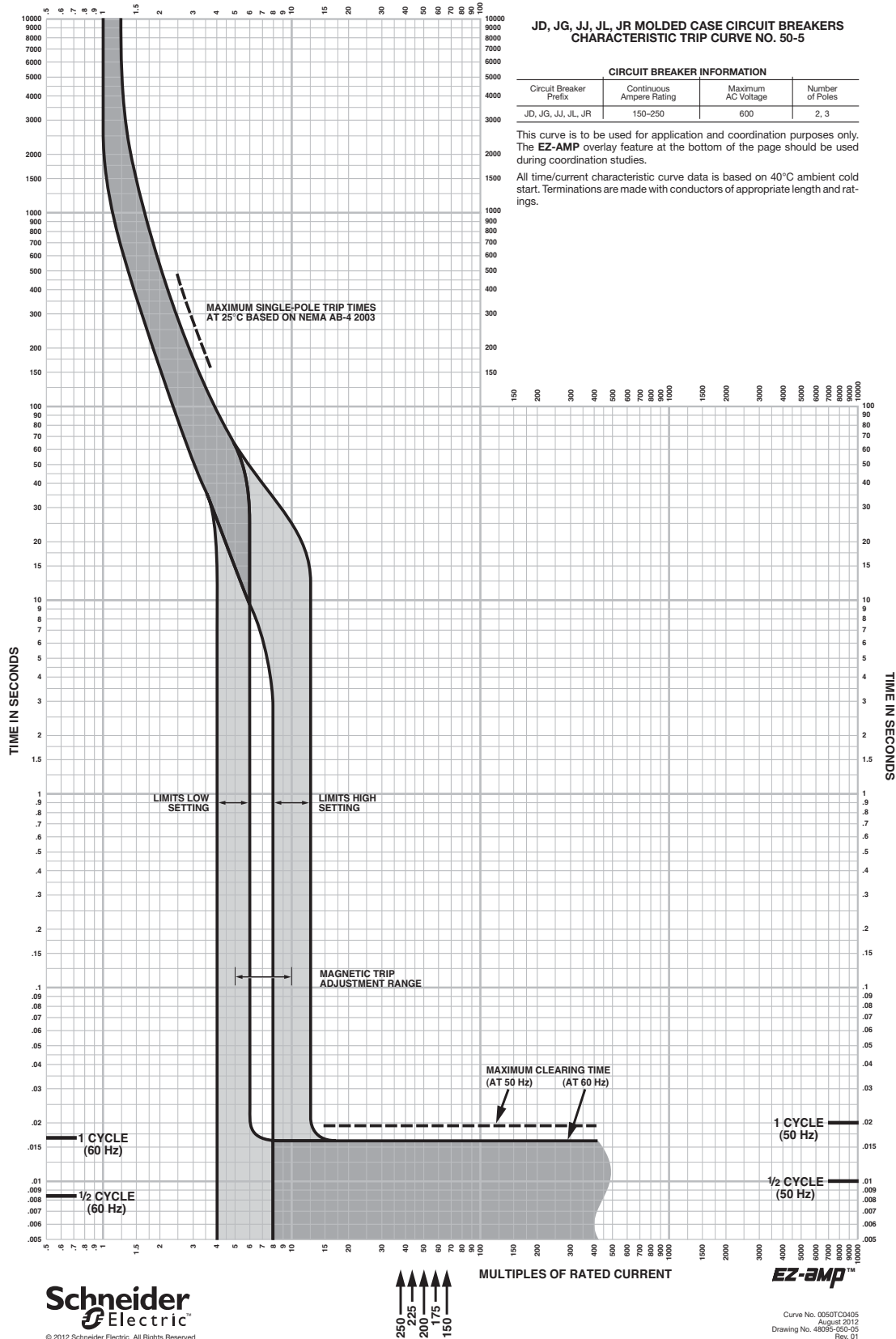

PowerPact™ H-, J-, and L-Frame Circuit Breakers Trip Curves

Figure 61: J-Frame 100 A (JG) 500 Vdc Thermal-Magnetic 500 Trip

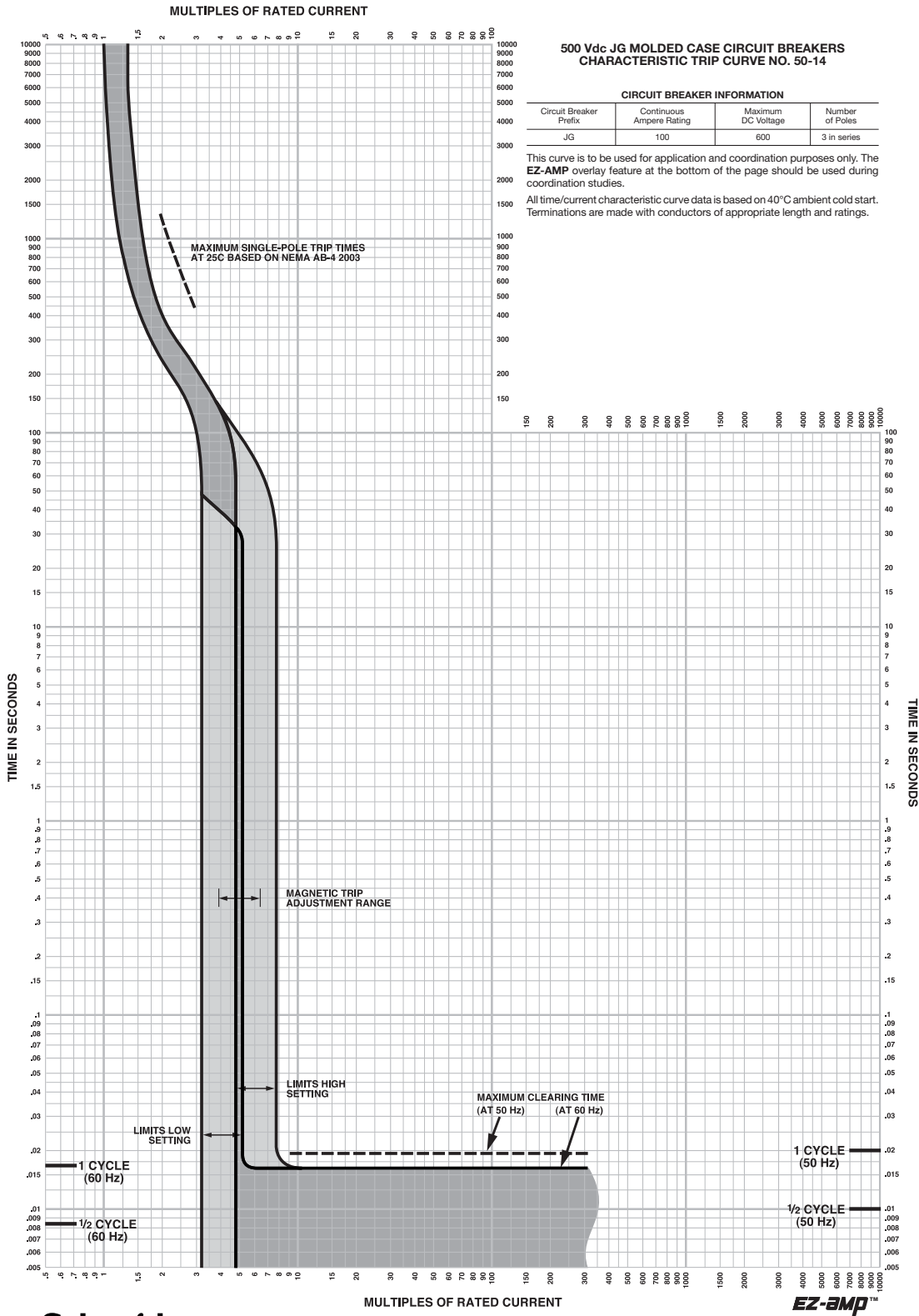

Curve No. 0350TC0914
September 2009
Drawing No. 48095-050-14

PowerPact™ H-, J-, and L-Frame Circuit Breakers Trip Curves

Figure 62: J-Frame 125 A (JG) 500 Vdc Thermal-Magnetic Trip

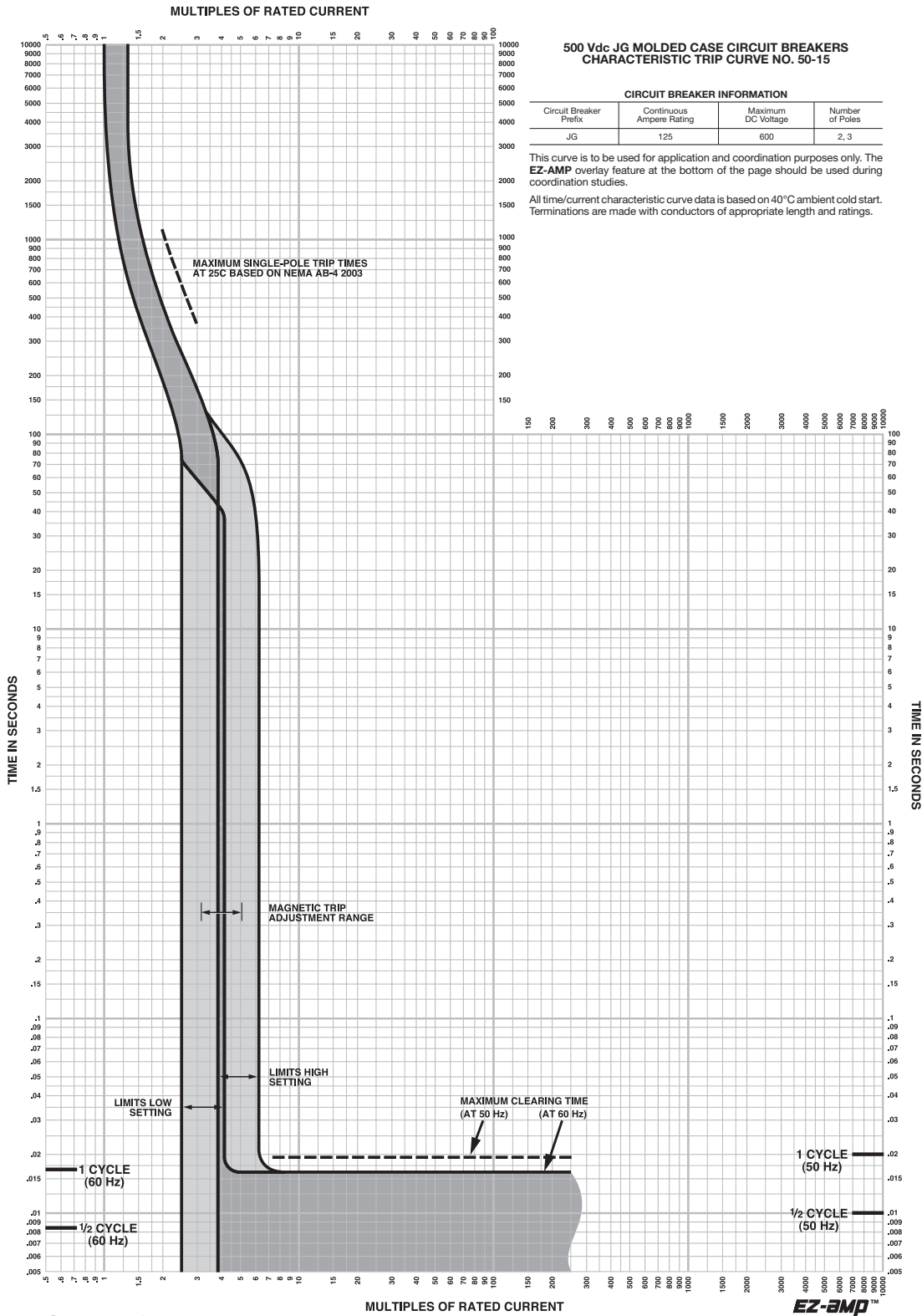

Schneider Electric

© 2009 Schneider Electric. All Rights Reserved

Curve No. 0050TC0915
September 2009
Drawing No. 48095-050-15

PowerPact™ H-, J-, and L-Frame Circuit Breakers Trip Curves

Figure 63: J-Frame 150 A (JG) 500 Vdc Thermal-Magnetic Trip

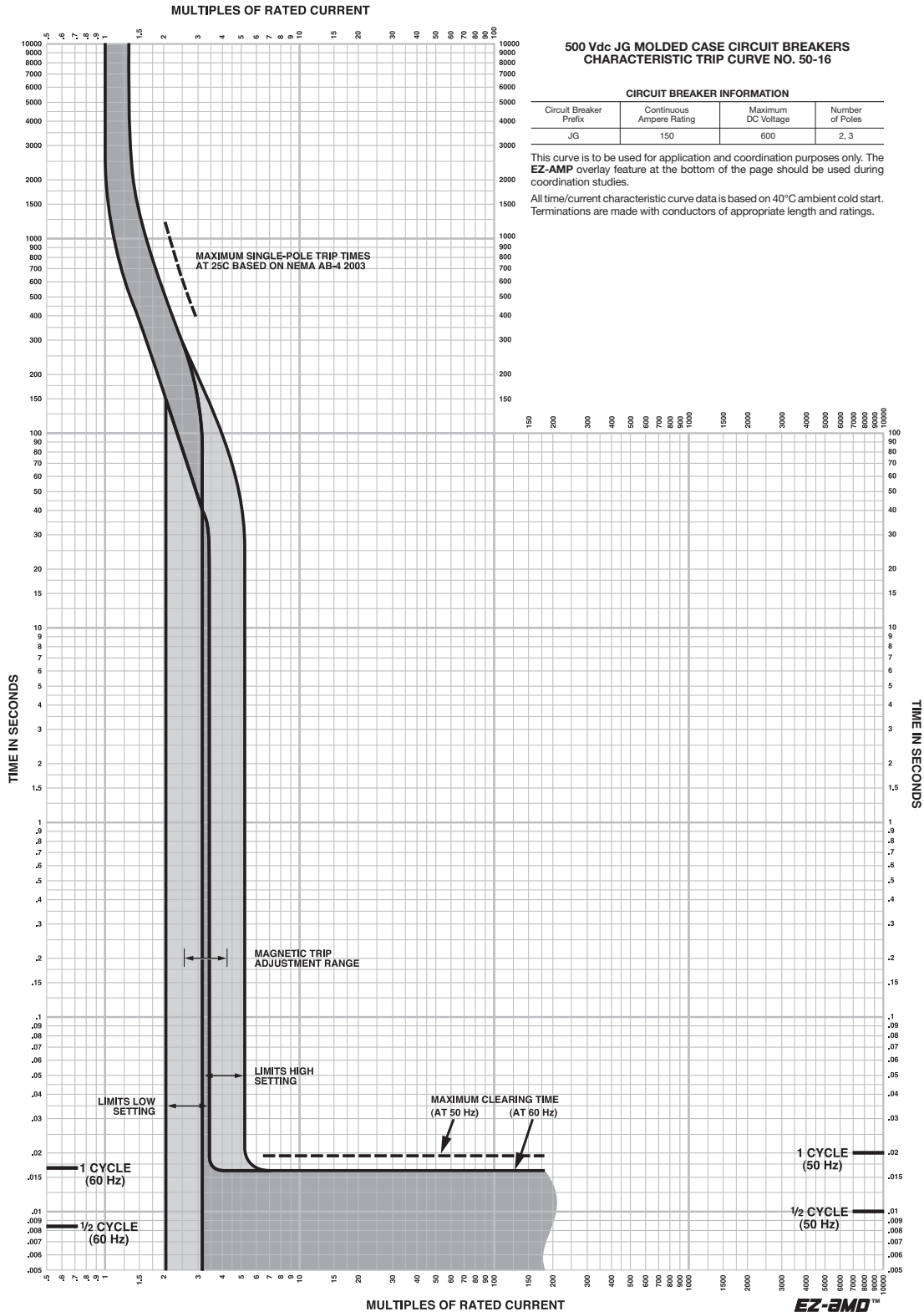

© 2009 Schneider Electric. All Rights Reserved.



Curve No. 0050TC0916
September 2009
Drawing No. 49095-100-16

PowerPact™ H-, J-, and L-Frame Circuit Breakers Trip Curves

Figure 64: J-Frame 175 A (JG) 500 Vdc Thermal-Magnetic Trip

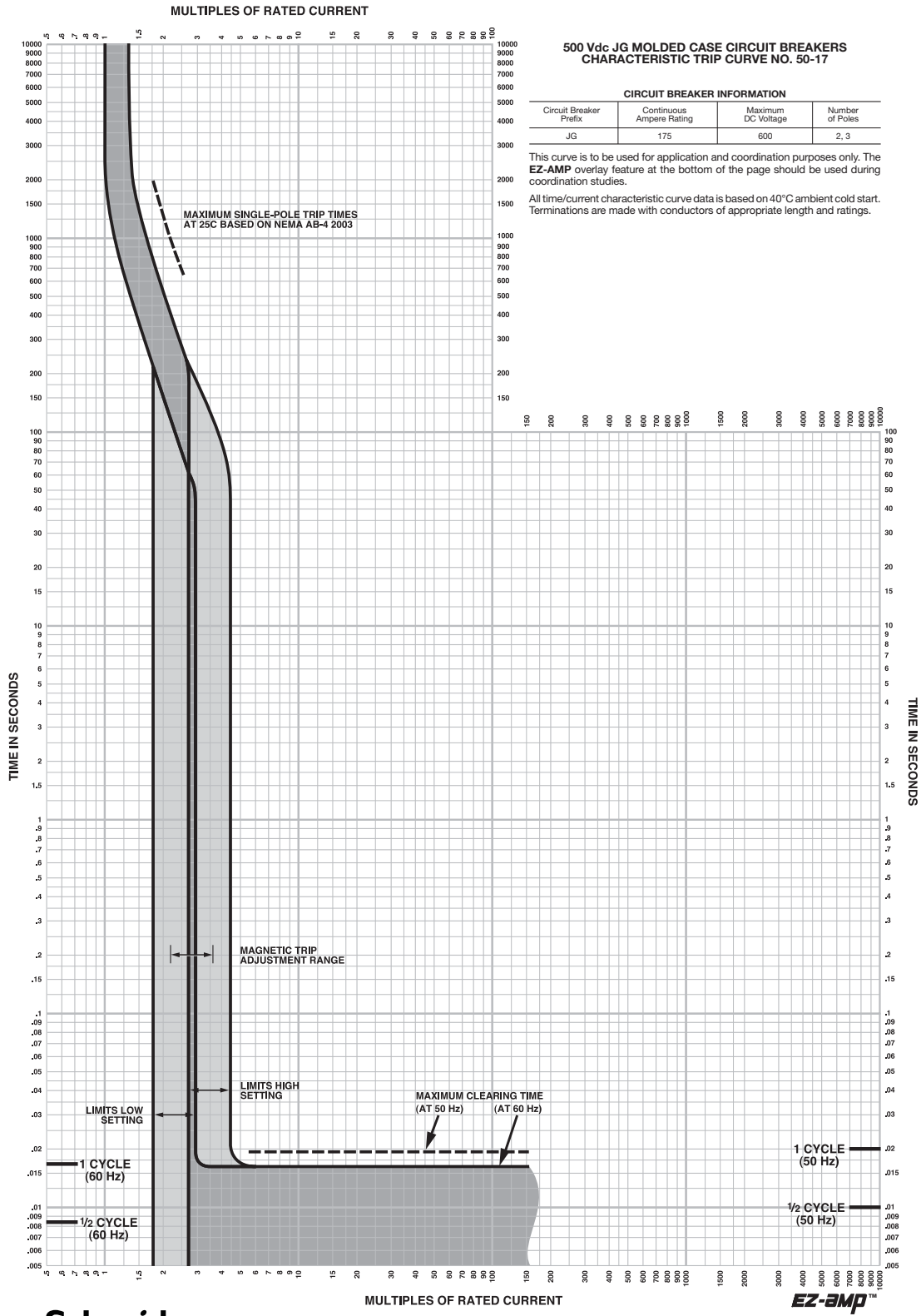

PowerPact™ H-, J-, and L-Frame Circuit Breakers Trip Curves

Figure 65: J-Frame 200 A (JG) 500 Vdc Thermal-Magnetic Trip

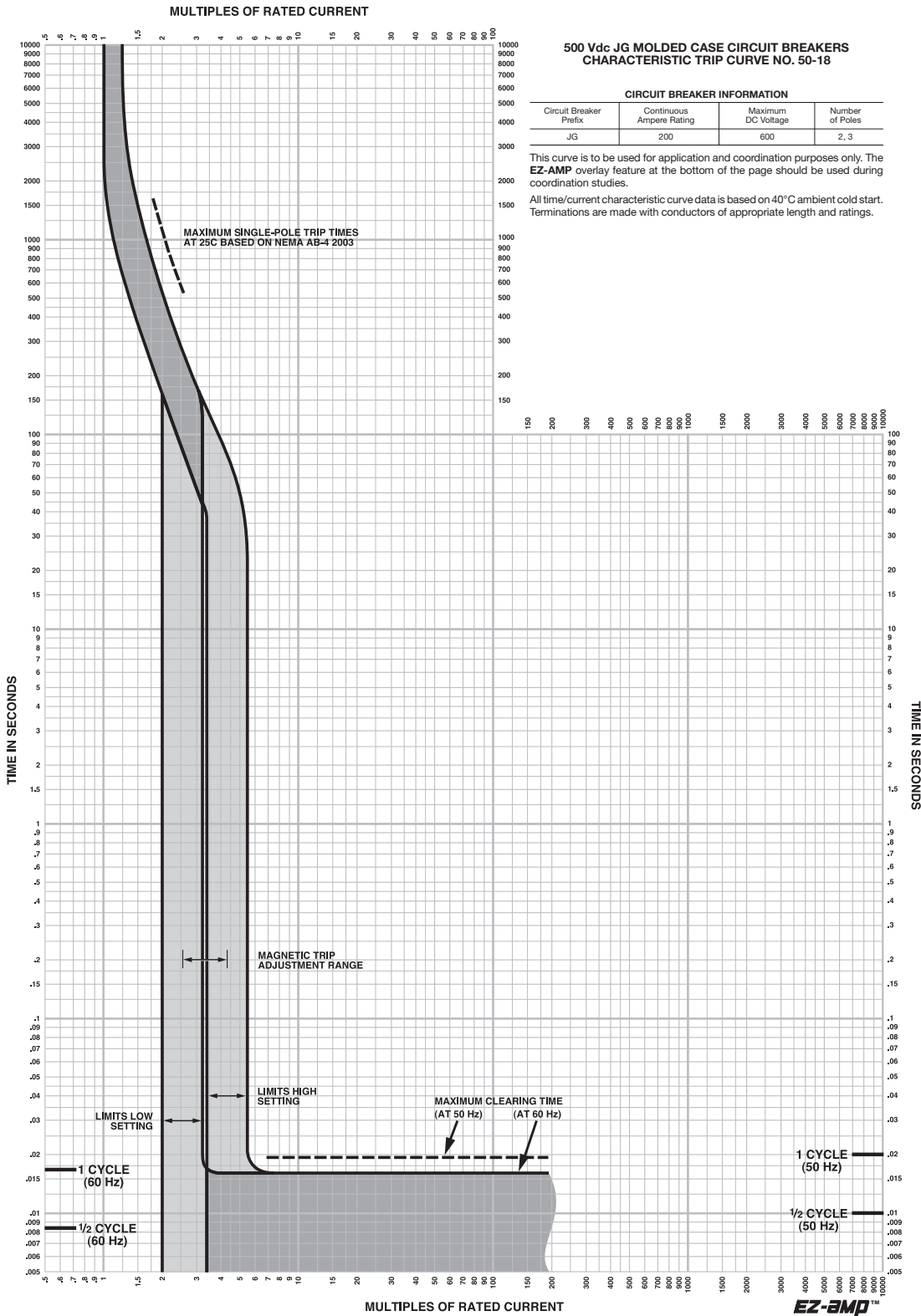

PowerPact™ H-, J-, and L-Frame Circuit Breakers Trip Curves

Figure 66: J-Frame 225 A (JG) 500 Vdc Thermal-Magnetic Trip

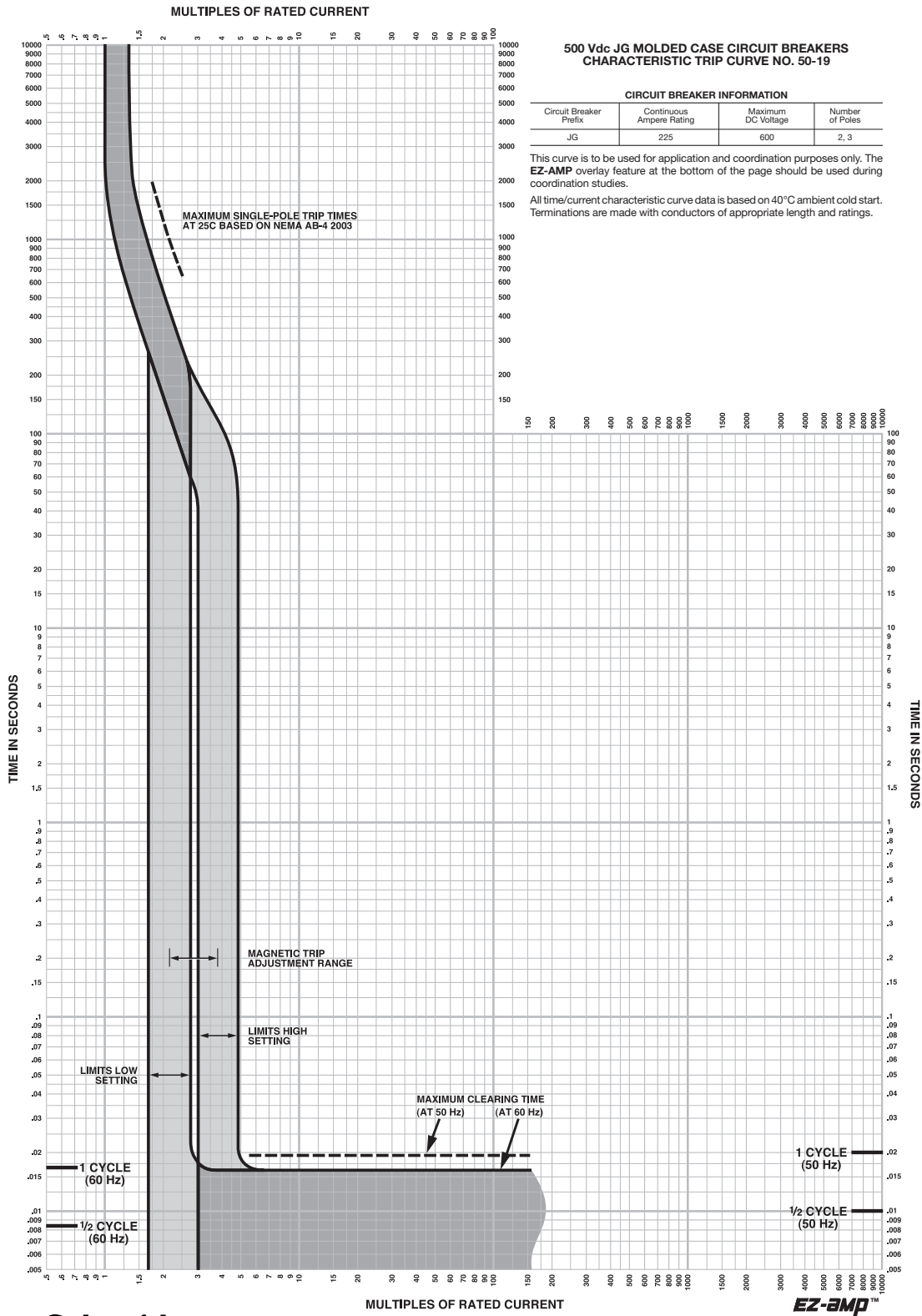

© 2009 Schneider Electric. All Rights Reserved

Curve No. 0050TC0919
September 2009
Drawing No. 48095-050-19

PowerPact™ H-, J-, and L-Frame Circuit Breakers Trip Curves

Figure 67: J-Frame 250 A (JG) 500 Vdc Thermal-Magnetic Trip

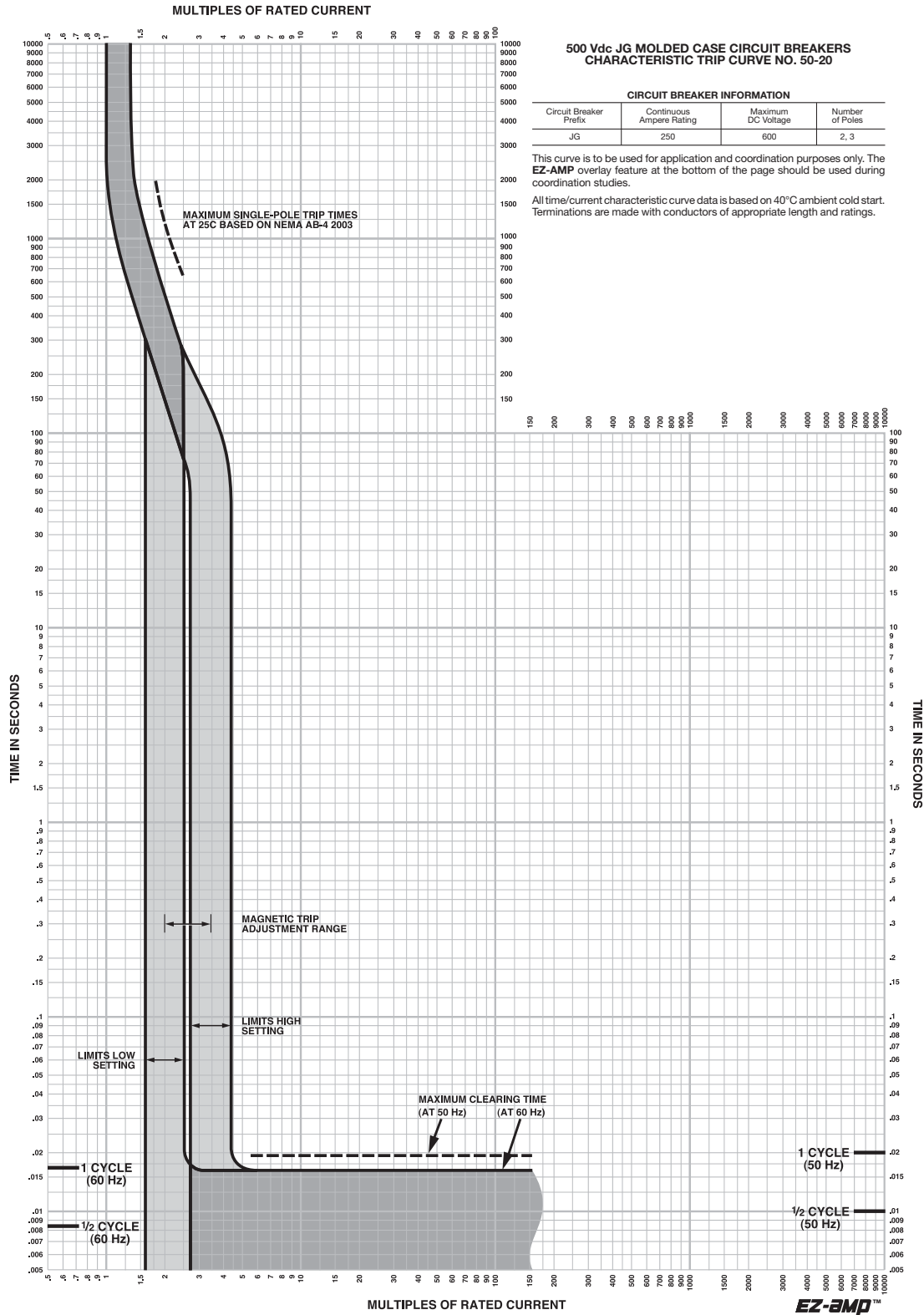

© 2009 Schneider Electric. All Rights Reserved



Curve No. 0550TC0920
September 2009
Drawing No. 48095-050-20

PowerPact™ H-, J-, and L-Frame Circuit Breakers Trip Curves

Figure 68: H-Frame 150 A Typical Peak Let-Through Curves

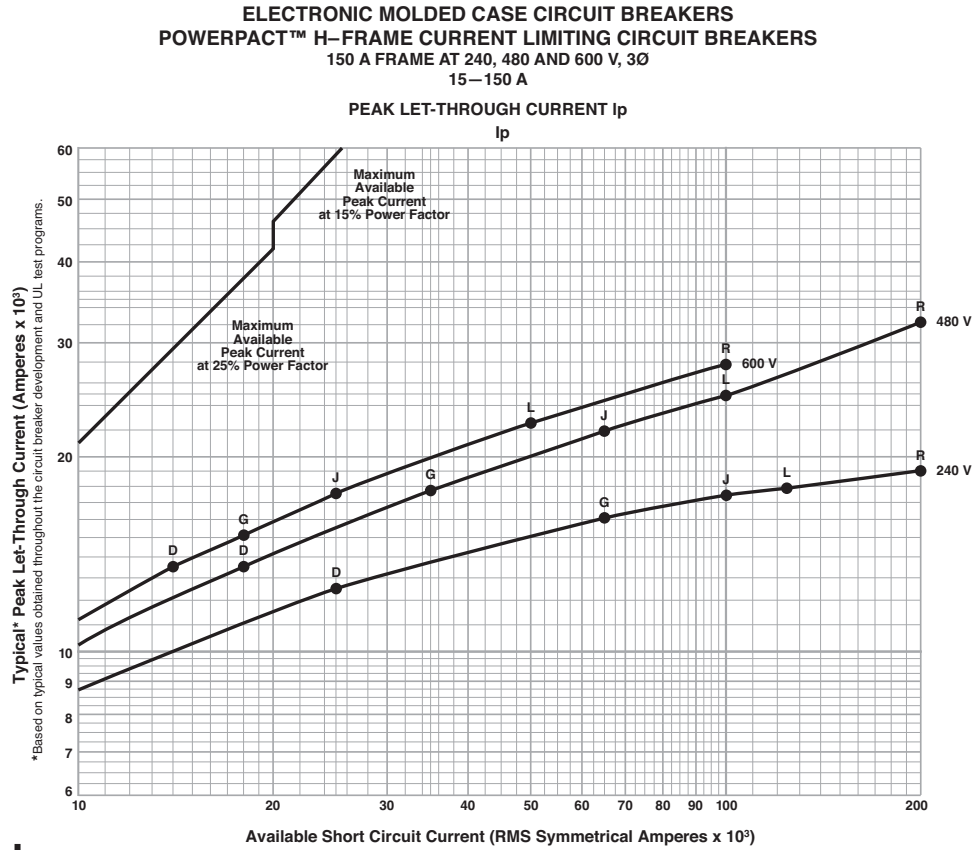

PowerPact™ H-, J-, and L-Frame Circuit Breakers Trip Curves

Figure 69: H-Frame 150 A Typical I²t Let-Through Curves

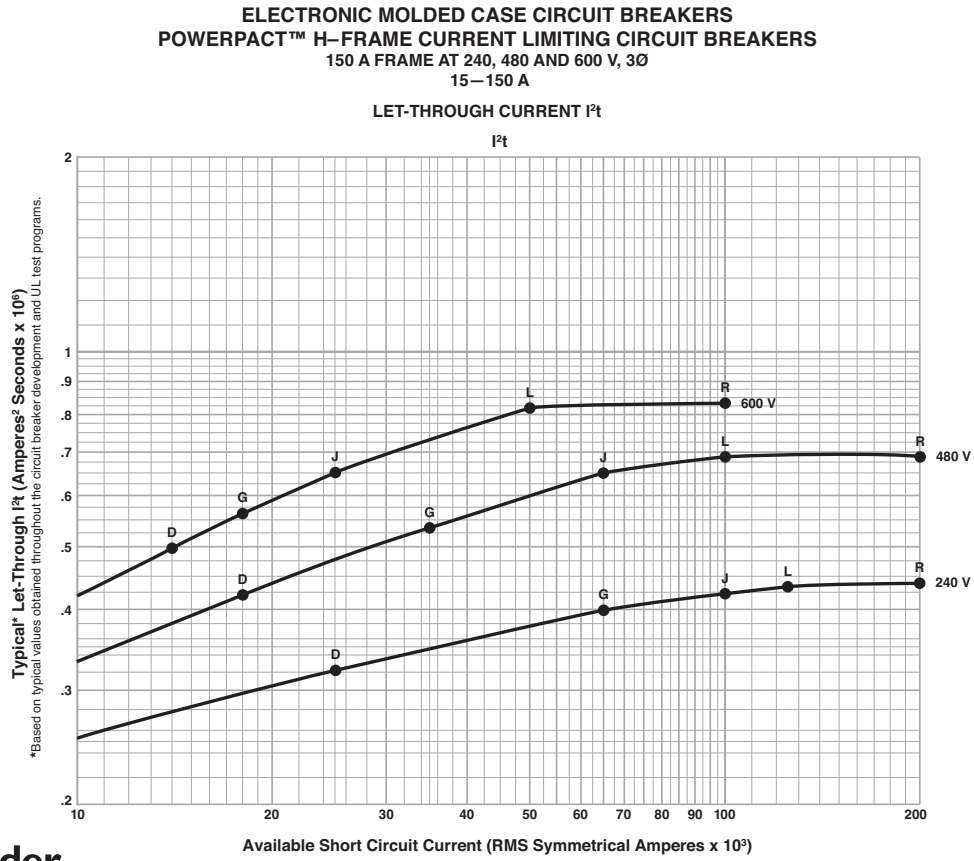

PowerPact™ H-, J-, and L-Frame Circuit Breakers Trip Curves

Figure 70: J-Frame 250 A Typical Peak Let-Through Curves

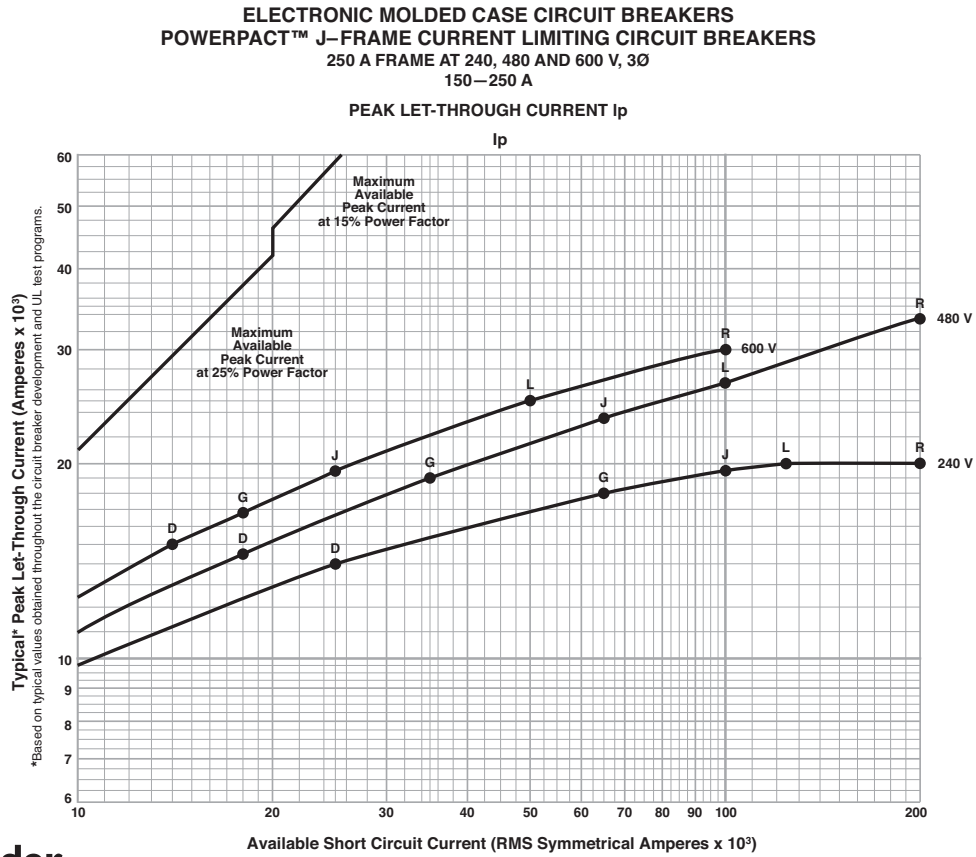

PowerPact™ H-, J-, and L-Frame Circuit Breakers Trip Curves

Figure 71: J-Frame 250 A Typical I²t Let-Through Curves

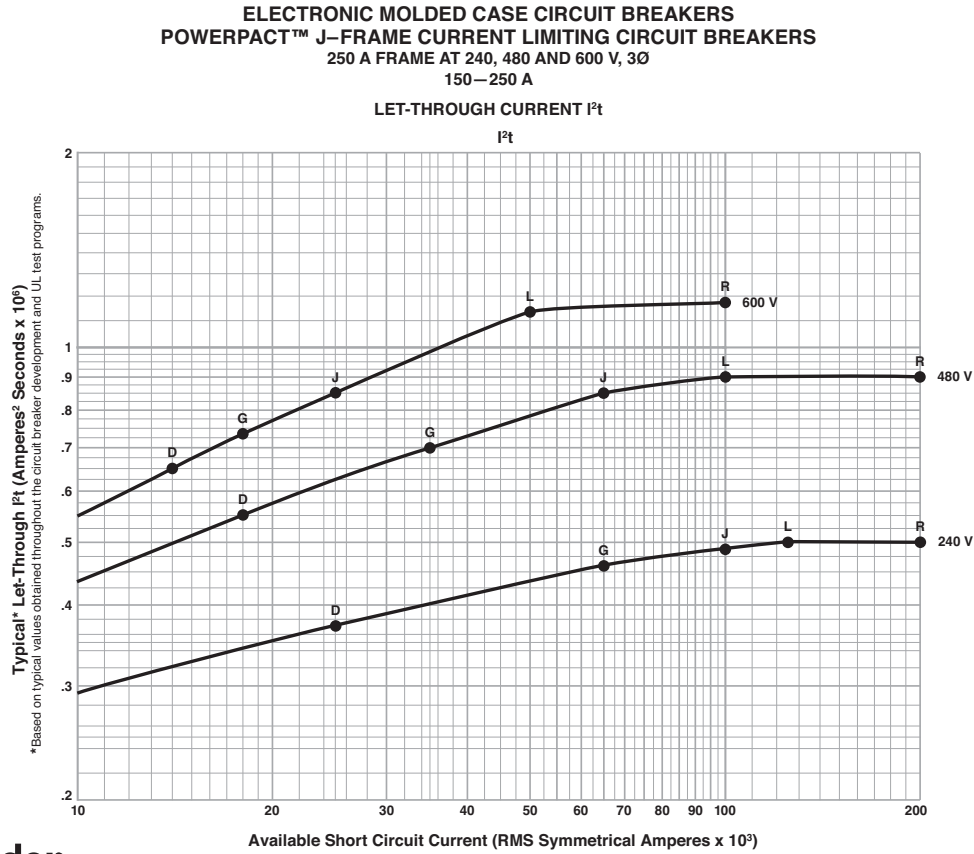

© 2012 Schneider Electric all rights reserved

Drawing No. 48095-050-08
April 2012
Rev. 01

PowerPact™ H-, J-, and L-Frame Circuit Breakers Trip Curves

Figure 72: H- and J-Frame Motor Circuit Protector

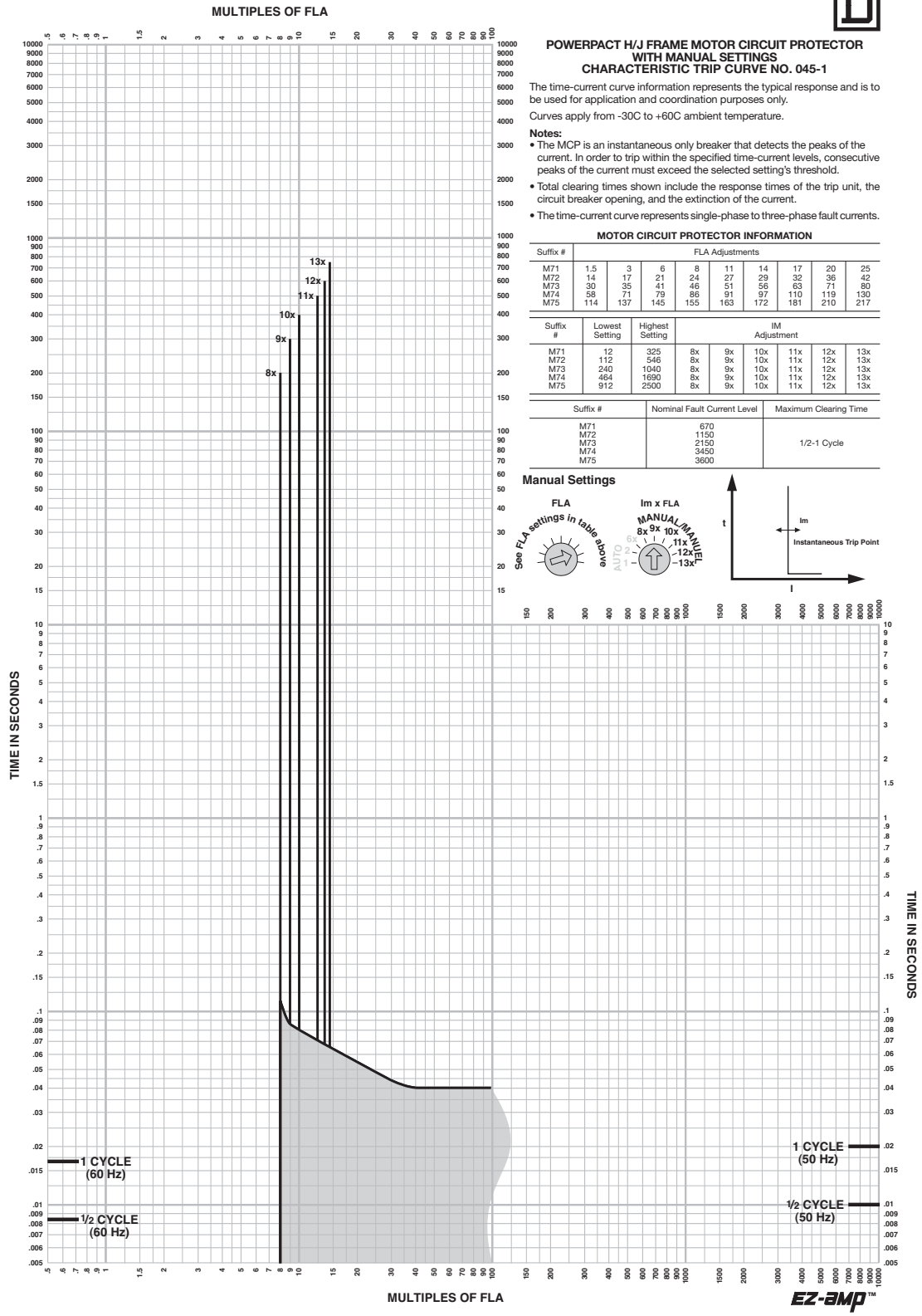

Curve No. 0045TC0601
August 2006
Drawing No. 48095-045-01

PowerPact™ H-, J-, and L-Frame Circuit Breakers Trip Curves

Figure 73: H-Frame UL Listed Current-Limiting Circuit Breaker

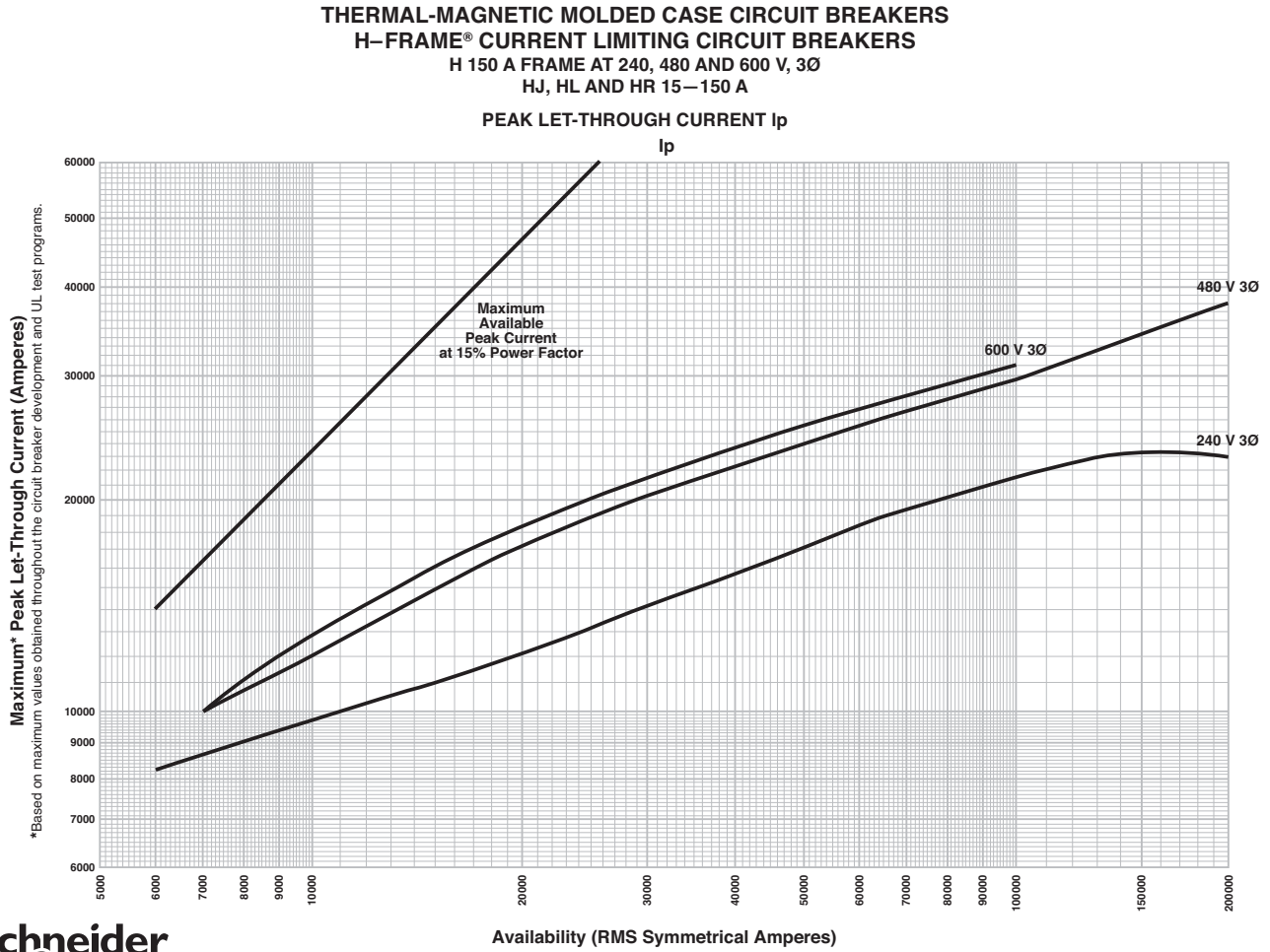

Schneider Electric
© 2012 Schneider Electric all rights reserved

Drawing No. 48095-050-10
April 2012
Rev. 02

PowerPact™ H-, J-, and L-Frame Circuit Breakers Trip Curves

Figure 74: H-Frame UL Listed Current-Limiting Circuit Breaker

THERMAL-MAGNETIC MOLDED CASE CIRCUIT BREAKERS
H-FRAME® CURRENT LIMITING CIRCUIT BREAKERS
H 150 A FRAME AT 240, 480 AND 600 V, 3Ø
HJ, HL AND HR 15–150 A
LET-THROUGH CURRENT I^2t

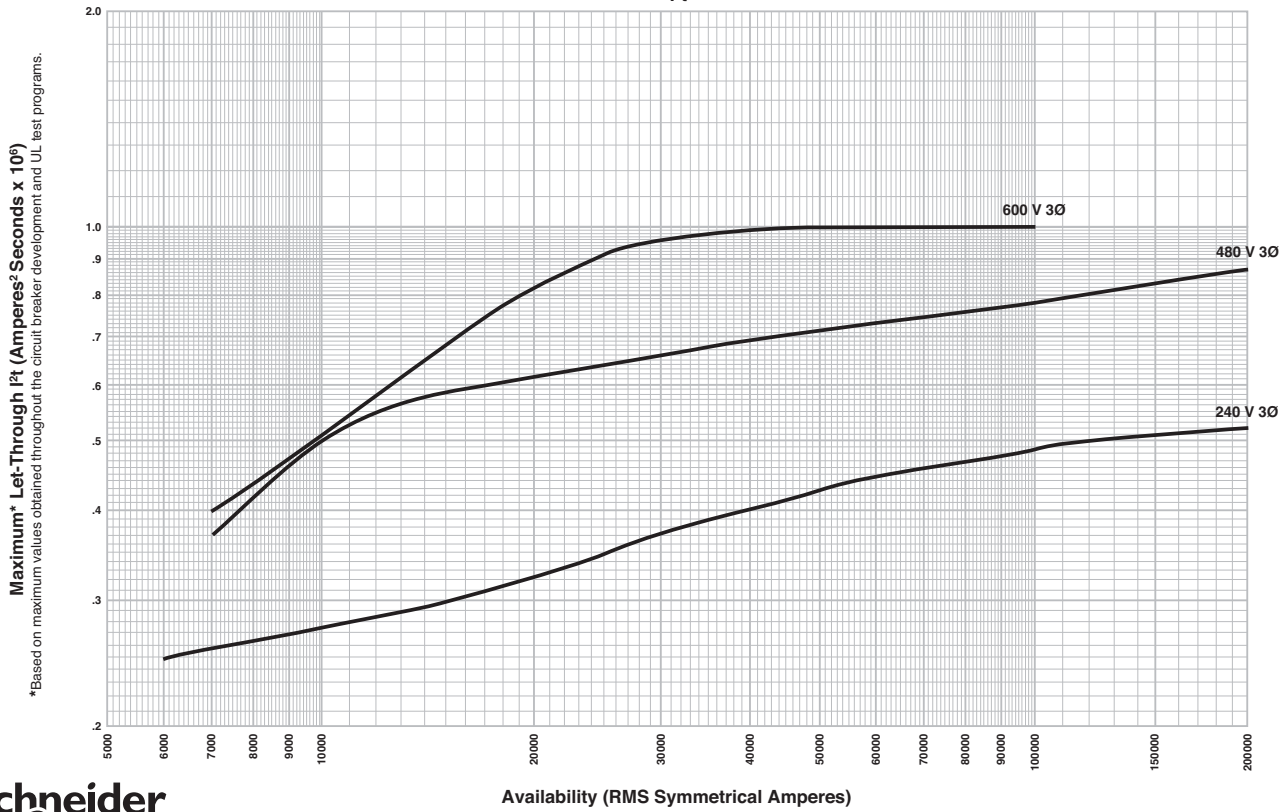

*Based on maximum values obtained throughout the circuit breaker development and UL test programs.



© 2012 Schneider Electric all rights reserved

Drawing No. 48095-050-11
April 2012
Rev. 02

PowerPact™ H-, J-, and L-Frame Circuit Breakers Trip Curves

Figure 75: J-Frame UL Listed Current -Limiting Circuit Breaker

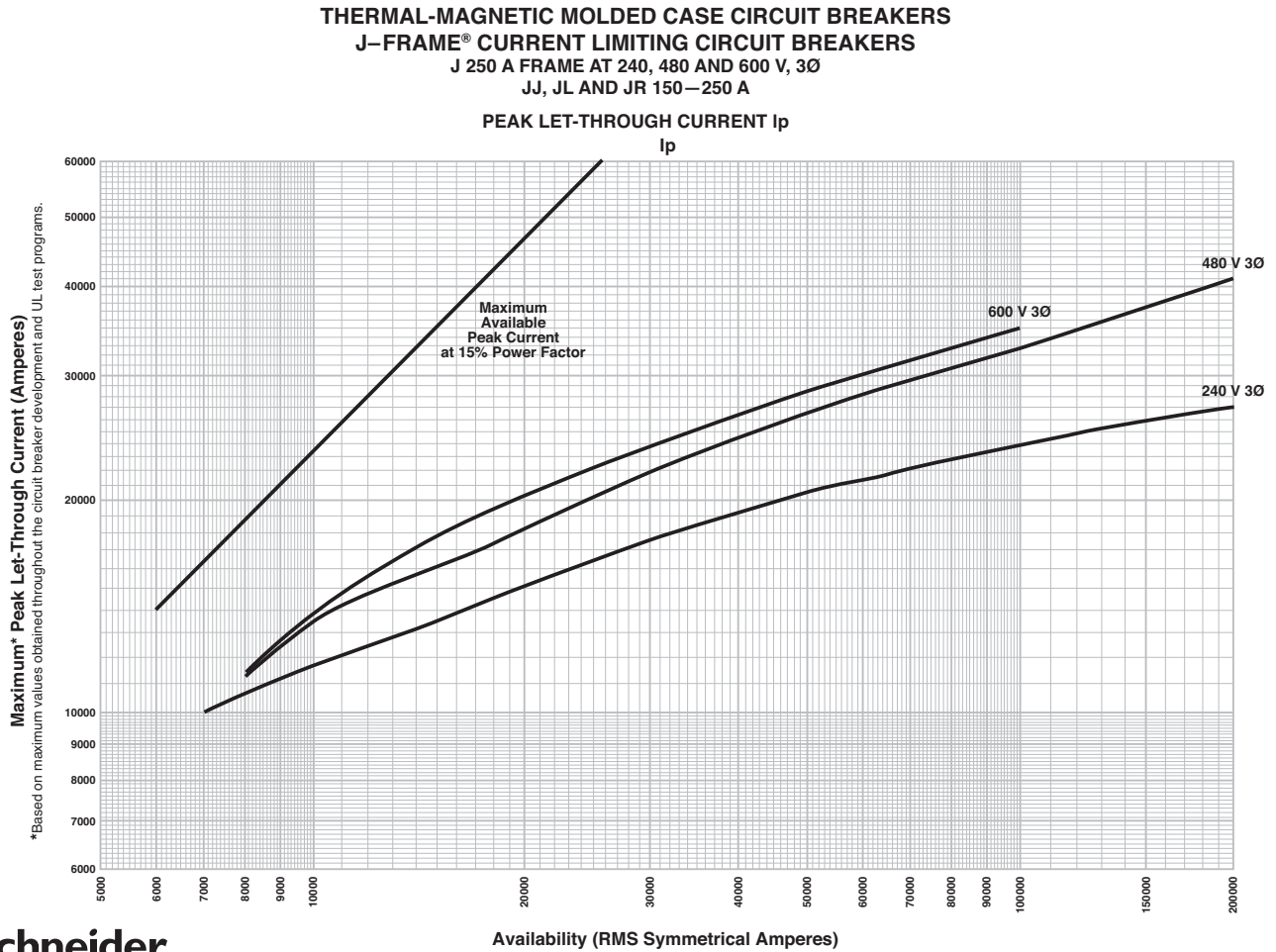

PowerPact™ H-, J-, and L-Frame Circuit Breakers Trip Curves

Figure 76: J-Frame UL Listed Current-Limiting Circuit Breaker

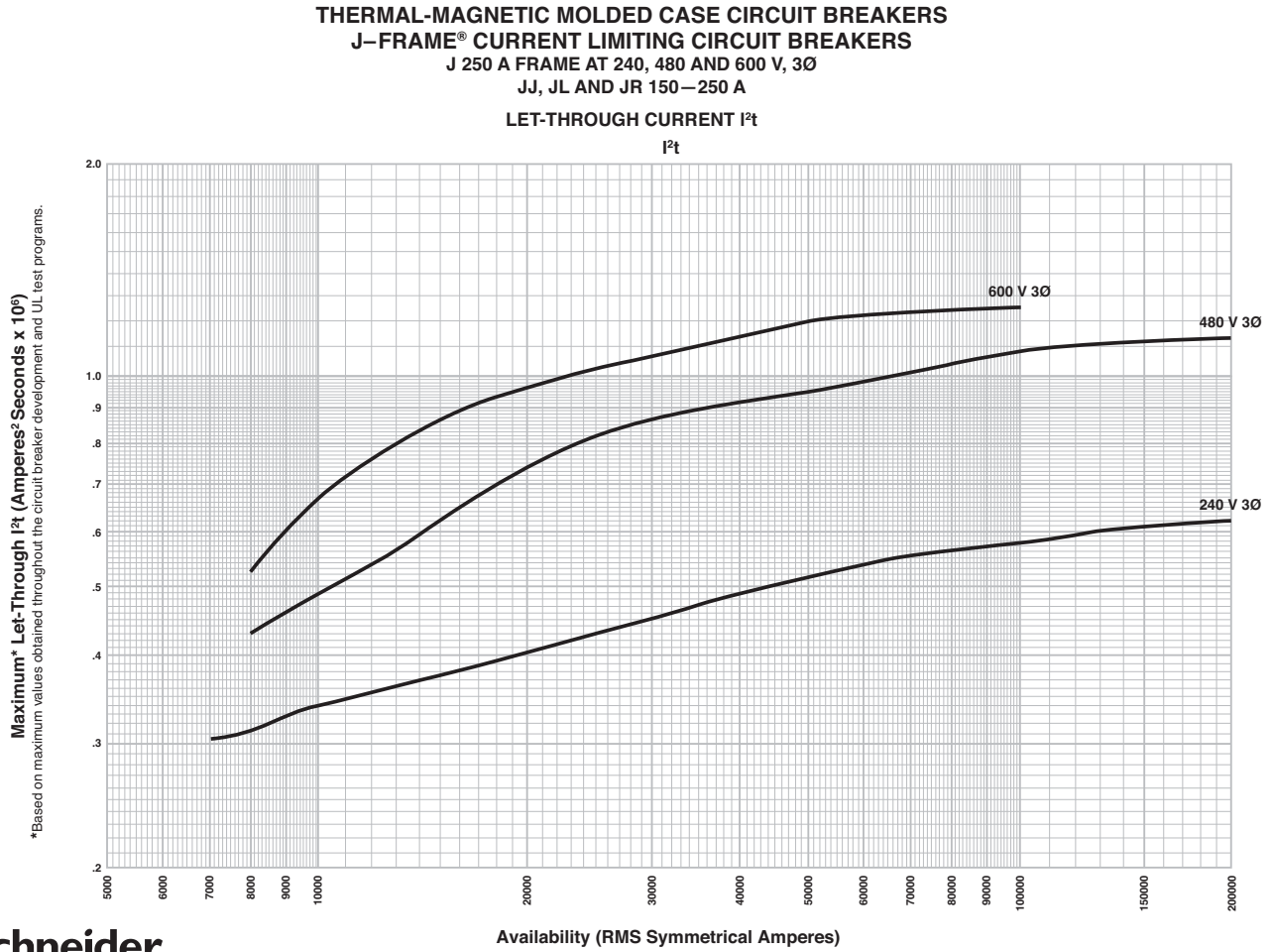

© 2012 Schneider Electric all rights reserved

Drawing No. 48095-050-13
 April 2012
 Rev. 02

PowerPact™ H-, J-, and L-Frame Circuit Breakers Trip Curves

Figure 77: Ground Fault Module GFM150HD Trip Curve

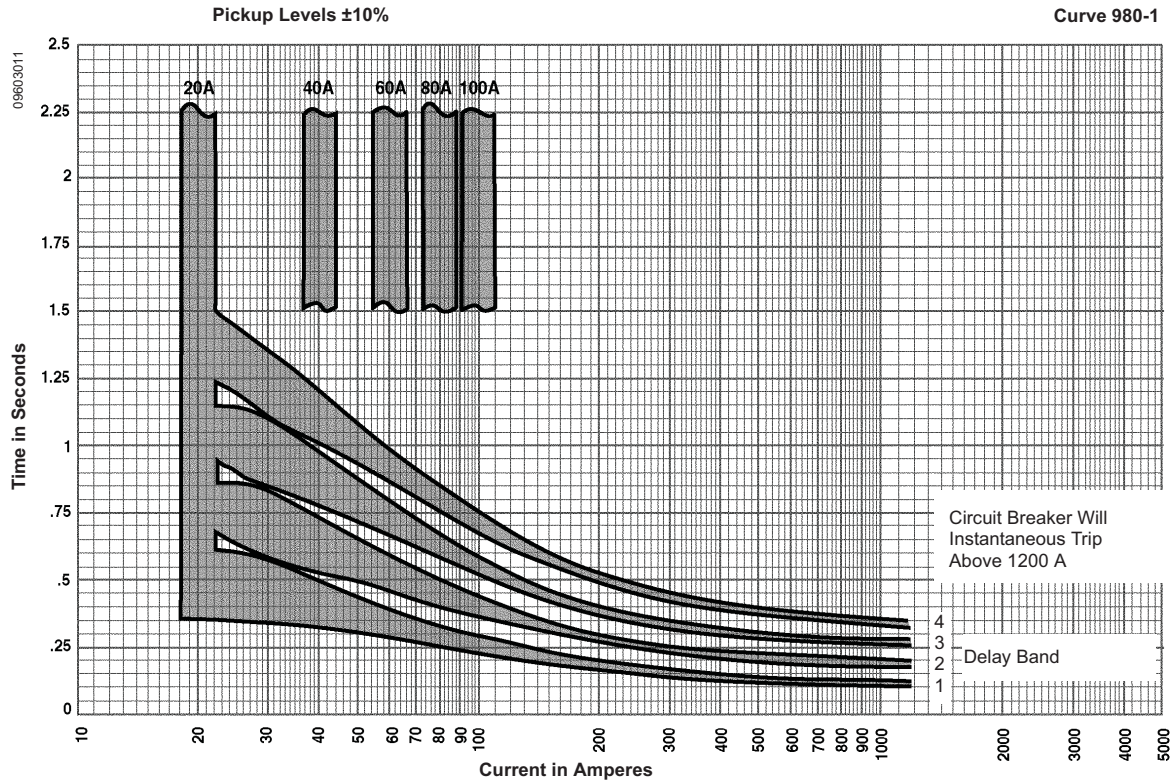
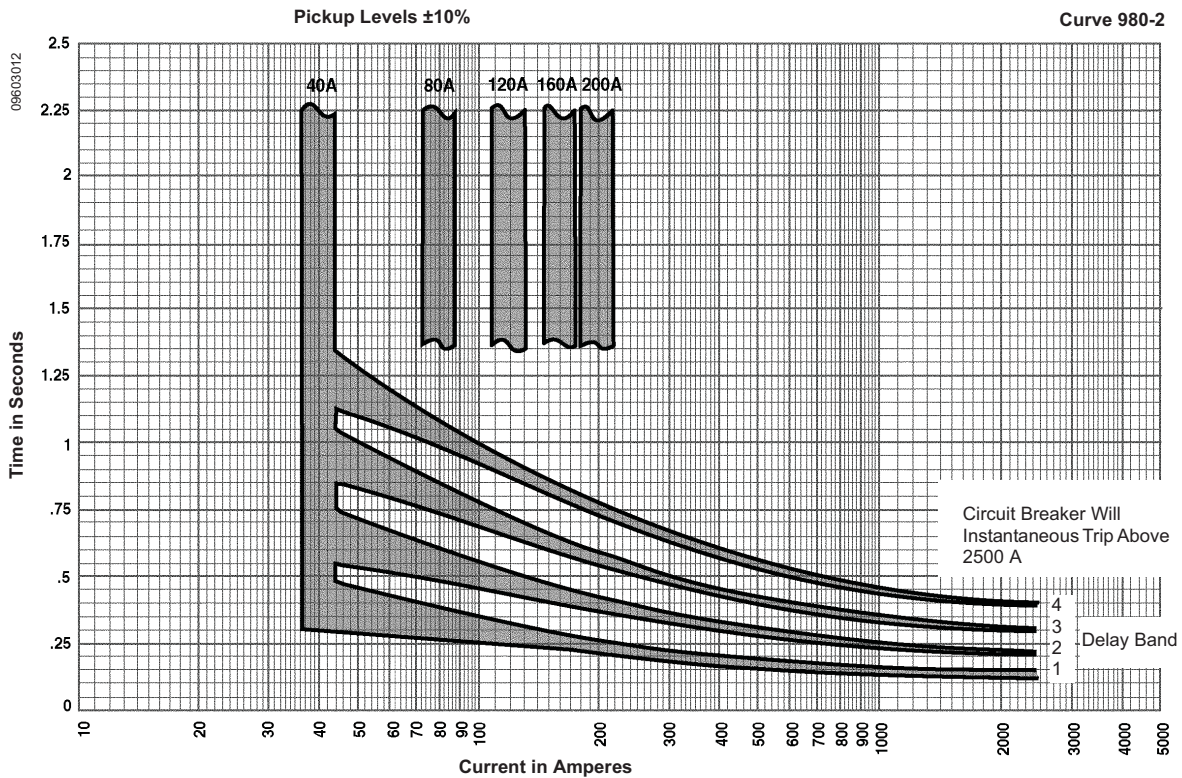
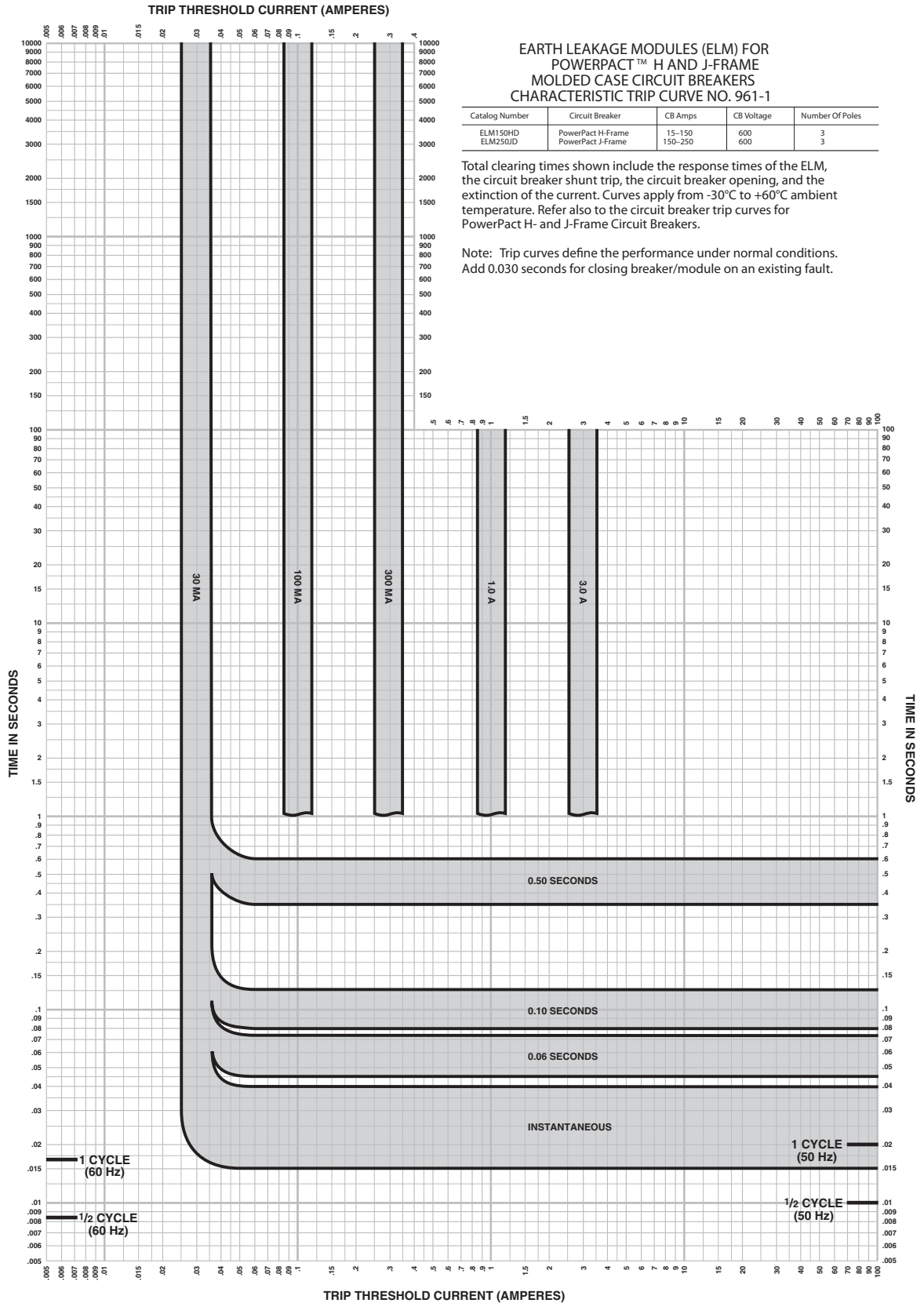

Figure 78: Ground Fault Module GFM250JD Trip Curve



PowerPact™ H-, J-, and L-Frame Circuit Breakers Trip Curves

Figure 79: Earth Leakage Module Trip Curve



PowerPact™ H-, J-, and L-Frame Circuit Breakers Trip Curves

PowerPact H- and J-Frame Thermal-Magnetic Trip MCP Instantaneous Trip Points

Table 141: M71 Instantaneous Trip Points

		Automatic Setting (A)		Manual Adjustment (A)						
I _m Setting		1	2	6x	8x	9x	10x	11x	12x	13x
Motor Type	NEMA	A, B, C, D	B, E	(FLA) x (I _m)						
	IEC	N	H							
FLA	1.5	12	16.5	9	12	13.5	15	16.5	18	19.5
	3	24	33	18	24	27	30	33	36	39
	6	48	66	36	48	54	60	66	72	78
	8	64	88	48	64	72	80	88	96	104
	11	88	121	66	88	99	110	121	132	143
	14	112	154	84	112	126	140	154	168	182
	17	136	187	102	136	153	170	187	204	221
	20	160	220	120	160	180	200	220	240	260
	25	200	275	150	200	225	250	275	300	325
Dampening for motor in-rush (% FLA)		1300%	1700%	1300%	—					

Table 142: M72 Instantaneous Trip Points

		Automatic Setting (A) ¹		Manual Adjustment (A) ¹						
I _m Setting		1	2	6x	8x	9x	10x	11x	12x	13x
Motor Type	NEMA	A, B, C, D	B, E	(FLA) x (I _m)						
	IEC	N	H							
FLA	14	112	154	84	112	126	140	154	168	182
	17	136	187	102	136	153	170	187	204	221
	21	168	231	126	168	189	210	231	252	273
	24	192	264	144	192	216	240	264	288	312
	27	216	297	162	216	243	270	297	324	351
	29	232	319	174	232	261	290	319	348	377
	32	256	352	192	256	288	320	352	384	416
	36	288	396	216	288	324	360	396	432	468
	42	336	462	252	336	378	420	462	504	546
Dampening for motor in-rush (% FLA)		1300%	1700%	1300%	—					

¹ ± 5% of nominal amperage shown above

PowerPact™ H-, J-, and L-Frame Circuit Breakers

Trip Curves

Table 143: M73 Instantaneous Trip Points

		Automatic Setting (A) ¹		Manual Adjustment (A) ¹						
I _m Setting		1	2	6x	8x	9x	10x	11x	12x	13x
Motor Type	NEMA	A, B, C, D	B, E	(FLA) x (I _m)						
	IEC	N	H							
FLA	30	240	330	180	240	270	300	330	360	390
	35	280	385	210	280	315	350	385	420	455
	41	328	451	246	328	369	410	451	492	533
	46	368	506	276	368	414	460	506	552	598
	51	408	561	306	408	459	510	561	612	663
	56	448	616	336	448	504	560	616	672	728
	63	504	693	378	504	567	630	693	756	819
	71	568	781	426	568	639	710	781	852	923
	80	640	880	480	640	720	800	880	960	1040
Dampening for motor in-rush (% FLA)		1300%	1700%	1300%	—					

¹ ± 5% of nominal amperage shown above

Table 144: M74 Instantaneous Trip Points

		Automatic Setting (A) ¹		Manual Adjustment (A) ¹						
I _m Setting		1	2	6x	8x	9x	10x	11x	12x	13x
Motor Type	NEMA	A, B, C, D	B, E	(FLA) x (I _m)						
	IEC	N	H							
FLA	58	464	638	348	464	522	580	638	696	754
	71	568	781	426	568	639	710	781	852	923
	79	632	869	474	632	711	790	869	948	1027
	86	688	946	516	688	774	860	946	1032	1118
	91	728	1001	546	728	819	910	1001	1092	1183
	97	776	1067	582	776	873	970	1067	1164	1261
	110	880	1210	660	880	990	1100	1210	1320	1430
	119	952	1309	714	952	1071	1190	1309	1428	1547
	130	1040	1430	780	1040	1170	1300	1430	1560	1690
Dampening for motor in-rush (% FLA)		1300%	1700%	1300%	—					

¹ ± 5% of nominal amperage shown above

Table 145: M75 Instantaneous Trip Points

		Automatic Setting (A) ¹		Manual Adjustment (A) ¹						
I _m Setting		1	2	6x	8x	9x	10x	11x	12x	13x
Motor Type	NEMA	A, B, C, D	B, E	(FLA) x (I _m)						
	IEC	N	H							
FLA	114	912	1254	684	912	1026	1140	1254	1368	1482
	137	1096	1507	822	1096	1233	1370	1507	1644	1781
	145	1160	1595	870	1160	1305	1450	1595	1740	1885
	155	1240	1705	930	1240	1395	1550	1705	1860	2015
	163	1304	1793	978	1304	1467	1630	1793	1956	2119
	172	1376	1892	1032	1376	1548	1720	1892	2064	2236
	181	1448	1991	1086	1448	1629	1810	1991	2172	2353
	210	1680	2310	1260	1680	1890	2100	2310	2500 ²	2500 ²
	217	1736	2387	1302	1736	1953	2170	2387	2500 ²	2500 ²
Dampening for motor in-rush (% FLA)		1100–1300%	1100–1700%	1100–1300%	—					

¹ ± 5% of nominal amperage shown above

² 2500 A maximum instantaneous trip point

PowerPact H-Frame Electronic Trip Circuit Breakers—
60 A/100 A/150 A Frame

Figure 80: Micrologic 3.2 Electronic Trip Unit Long Time Trip Curve

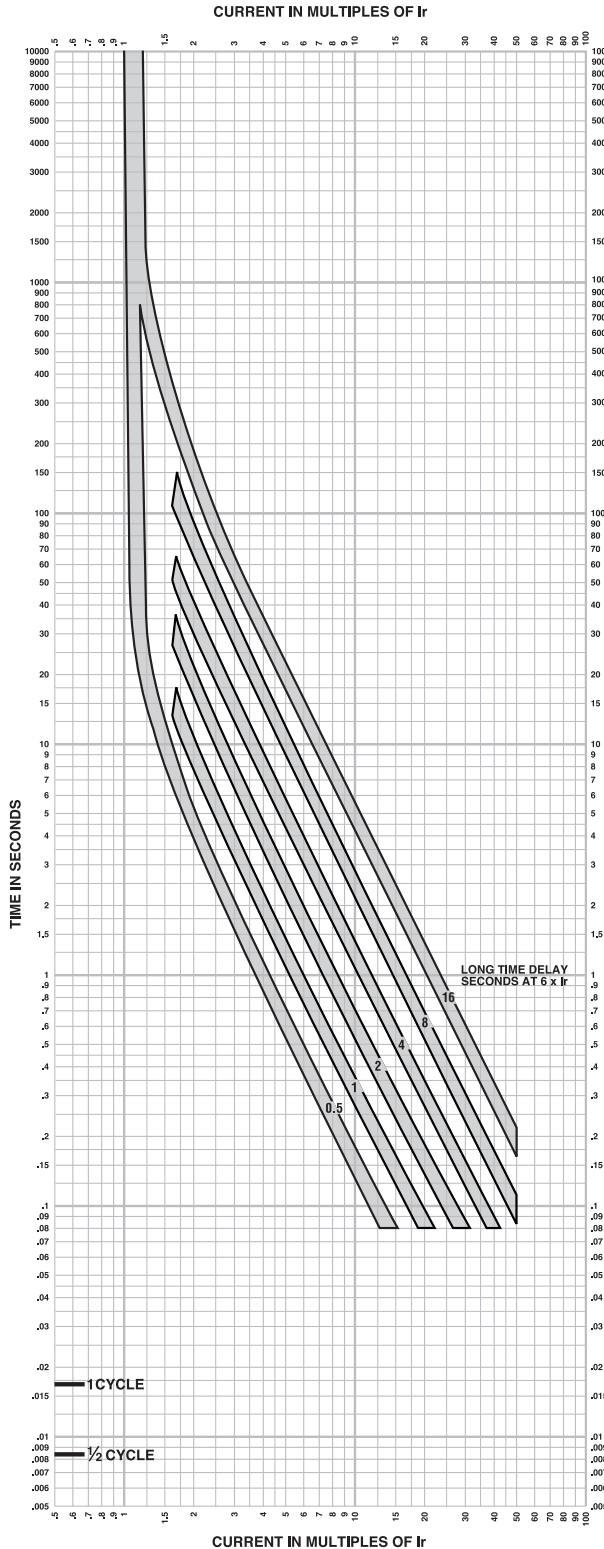

MICROLOGIC™ ELECTRONIC TRIP UNITS
Micrologic™ 3.2 Long Time Trip Curve
60A, 100A, 150A H-Frame

The time-current curve information is to be used for application and coordination purposes only.

Notes:

1. There is a thermal-imaging effect that can act to shorten the long-time delay. The thermal imaging effect comes into play if a current above the long-time delay pickup value exists for a time and then is cleared by the tripping of a downstream device or the circuit breaker itself. A subsequent overload will cause the circuit breaker to trip in a shorter time than normal. The amount of time delay reduction is inverse to the amount of time that has elapsed since the previous overload. Approximately 20 minutes is required between overloads to completely reset thermal-imaging.
2. Total clearing times shown include the response times of the trip unit, the circuit breaker opening, and the extinction of the current.

Curves apply from -35°C to +70°C (-31°F to +158°F) ambient temperature.

PowerPact™ H-, J-, and L-Frame Circuit Breakers Trip Curves

Figure 81: Micrologic 3.2S Electronic Trip Unit Long Time / Short Time Trip Curve

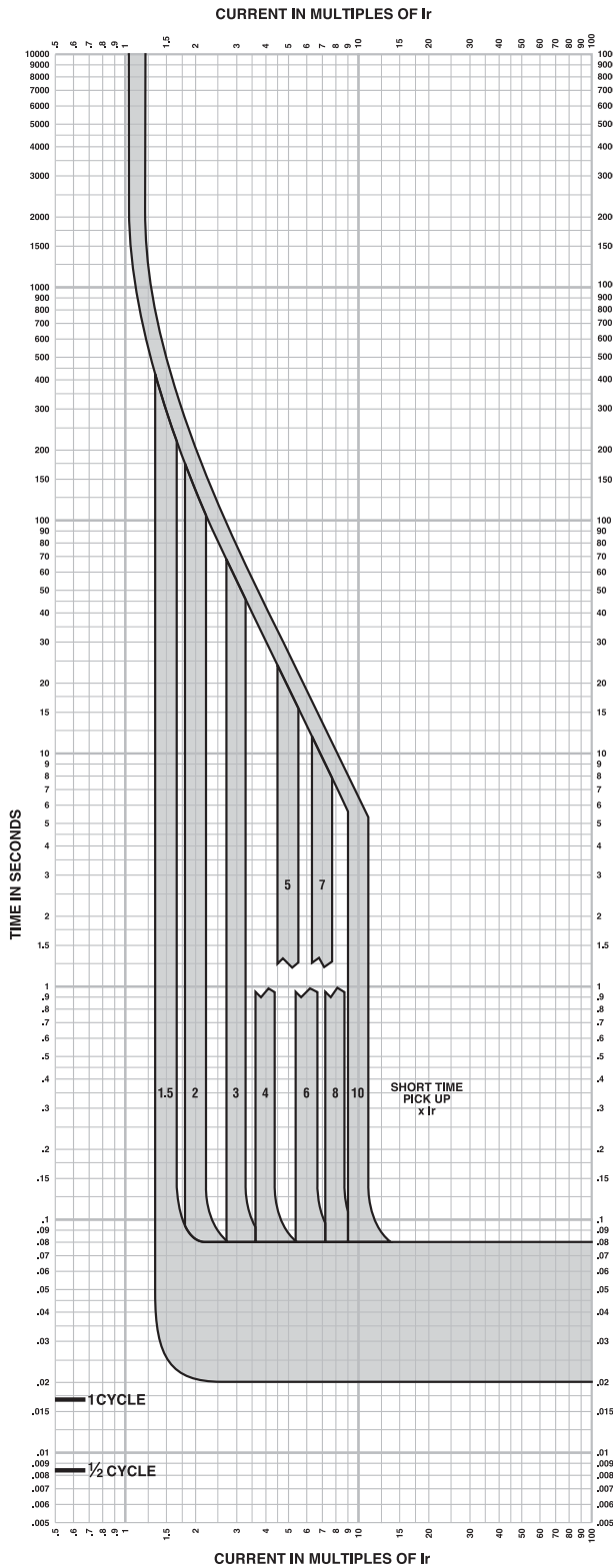

MICROLOGIC™ ELECTRONIC TRIP UNITS Micrologic™ 3.2S Long Time/ Short Time Trip Curve 60A, 100A, 150A H-Frame

The time-current curve information is to be used for application and coordination purposes only.

Notes:

1. There is a thermal-imaging effect that can act to shorten the long-time delay. The thermal imaging effect comes into play if a current above the long-time delay pickup value exists for a time and then is cleared by the tripping of a downstream device or the circuit breaker itself. A subsequent overload will cause the circuit breaker to trip in a shorter time than normal. The amount of time delay reduction is inverse to the amount of time that has elapsed since the previous overload. Approximately 20 minutes is required between overloads to completely reset thermal-imaging.
2. Total clearing times shown include the response times of the trip unit, the circuit breaker opening, and the extinction of the current.

Curves apply from -35°C to +70°C (-31°F to +158°F) ambient temperature.

PowerPact™ H-, J-, and L-Frame Circuit Breakers Trip Curves

Figure 82: Micrologic 3.2/3.2S/5.2A/5.2E/6.2A/6.2E Electronic Trip Unit Instantaneous Trip Curve

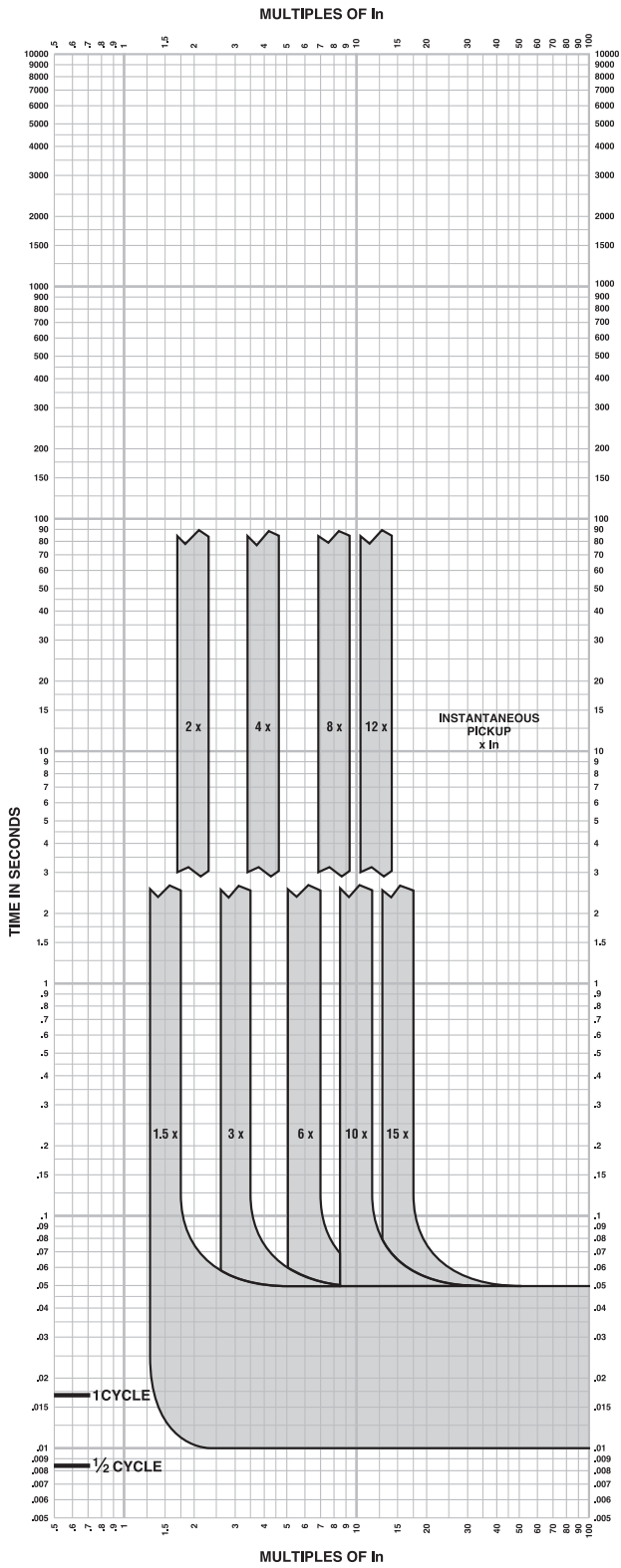

MICROLOGIC™ ELECTRONIC TRIP UNITS Micrologic™ 3.2/3.2S/5.2A or E/6.2A or E Instantaneous Trip Curve 60A, 100A, 150A H-Frame

The time-current curve information is to be used for application and coordination purposes only.

Notes:

1. There is a thermal-imaging effect that can act to shorten the long-time delay. The thermal imaging effect comes into play if a current above the long-time delay pickup value exists for a time and then is cleared by the tripping of a downstream device or the circuit breaker itself. A subsequent overload will cause the circuit breaker to trip in a shorter time than normal. The amount of time delay reduction is inverse to the amount of time that has elapsed since the previous overload. Approximately 20 minutes is required between overloads to completely reset thermal-imaging.
 2. Total clearing times shown include the response times of the trip unit, the circuit breaker opening, and the extinction of the current.
 3. In = Maximum dial setting of Ir.
60A H-Frame: In = 60A = Max Ir setting
100A H-Frame: In = 100A = Max Ir setting
150A H-Frame: In = 150A = Max Ir setting
- Curves apply from -35°C to +70°C (-31°F to +158°F) ambient temperature.

PowerPact™ H-, J-, and L-Frame Circuit Breakers Trip Curves

Figure 83: Micrologic 5.2A/5.2E/6.2A/6.2E Electronic Trip Unit Long Time Trip Curve

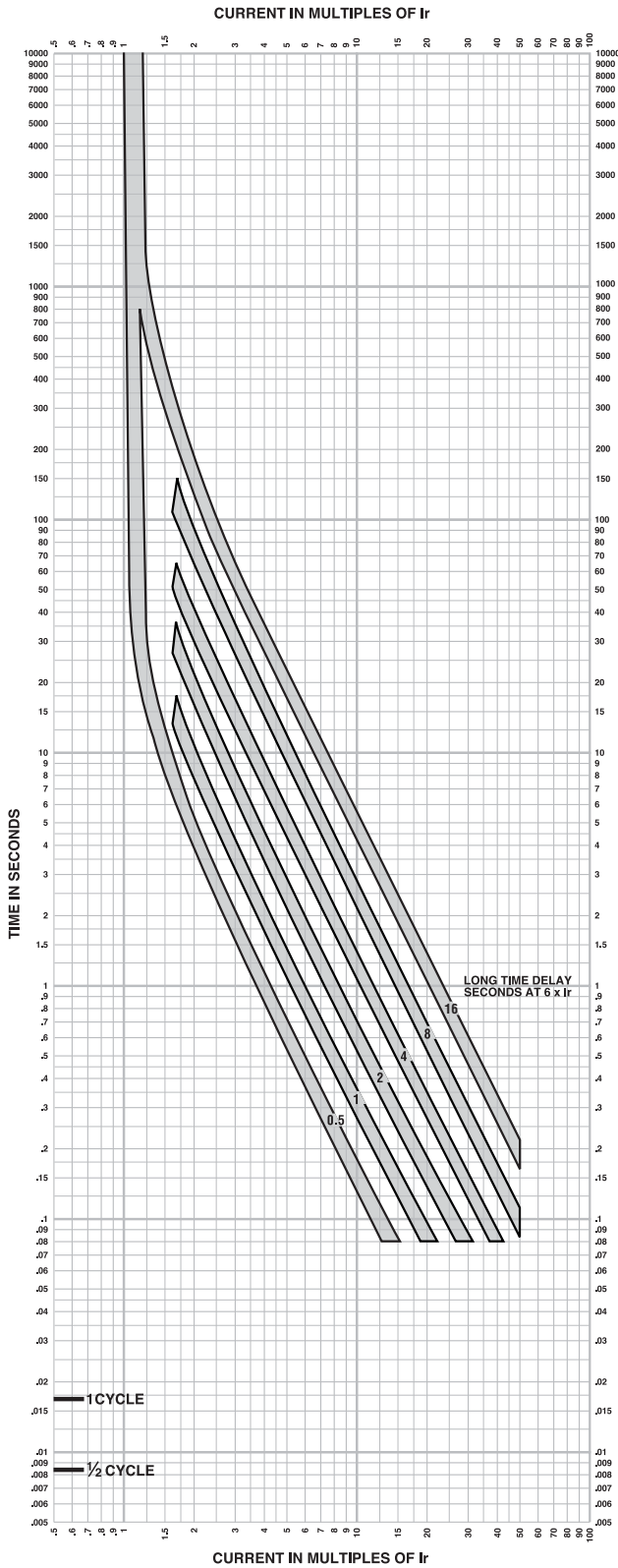

MICROLOGIC™ ELECTRONIC TRIP UNITS Micrologic™ 5.2A or E/6.2A or E Long Time Trip Curve 60A, 100A, 150A H-Frame

The time-current curve information is to be used for application and coordination purposes only.

Notes:

1. There is a thermal-imaging effect that can act to shorten the long-time delay. The thermal imaging effect comes into play if a current above the long-time delay pickup value exists for a time and then is cleared by the tripping of a downstream device or the circuit breaker itself. A subsequent overload will cause the circuit breaker to trip in a shorter time than normal. The amount of time delay reduction is inverse to the amount of time that has elapsed since the previous overload. Approximately 20 minutes is required between overloads to completely reset thermal-imaging.
2. Total clearing times shown include the response times of the trip unit, the circuit breaker opening, and the extinction of the current.

Curves apply from -35°C to +70°C (-31°F to +158°F) ambient temperature.

PowerPact™ H-, J-, and L-Frame Circuit Breakers Trip Curves

Figure 84: Micrologic 5.2A/5.2E/6.2A/6.2E Electronic Trip Unit Short Time Trip Curve

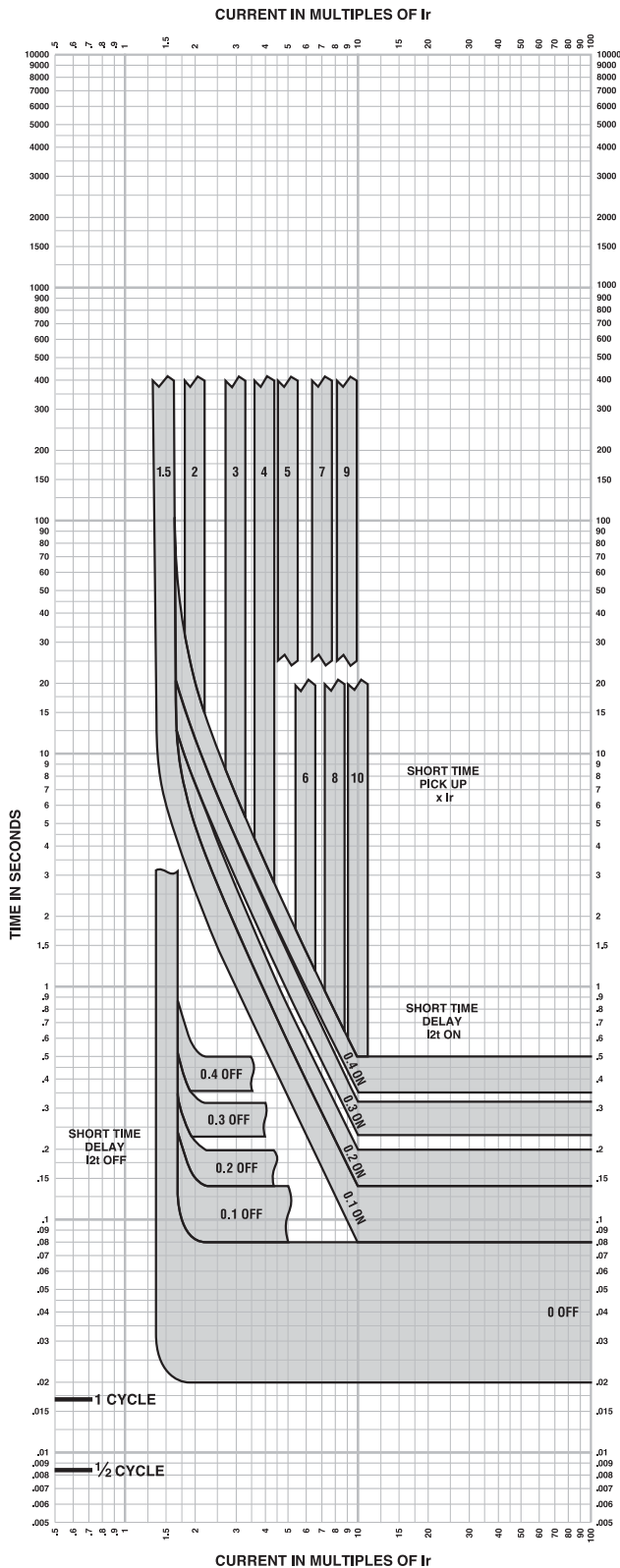

MICROLOGIC™ ELECTRONIC TRIP UNITS Micrologic™ 5.2A or E/6.2A or E Short Time Trip Curve 60A, 100A, 150A H-Frame

The time-current curve information is to be used for application and coordination purposes only.

Notes:

1. There is a thermal-imaging effect that can act to shorten the long-time delay. The thermal imaging effect comes into play if a current above the long-time delay pickup value exists for a time and then is cleared by the tripping of a downstream device or the circuit breaker itself. A subsequent overload will cause the circuit breaker to trip in a shorter time than normal. The amount of time delay reduction is inverse to the amount of time that has elapsed since the previous overload. Approximately 20 minutes is required between overloads to completely reset thermal-imaging.
2. Total clearing times shown include the response times of the trip unit, the circuit breaker opening, and the extinction of the current.

Curves apply from -35°C to +70°C (-31°F to +158°F) ambient temperature.

PowerPact™ H-, J-, and L-Frame Circuit Breakers Trip Curves

Figure 85: Micrologic 6.2A/6.2E Electronic Trip Unit Ground Fault Trip Curve

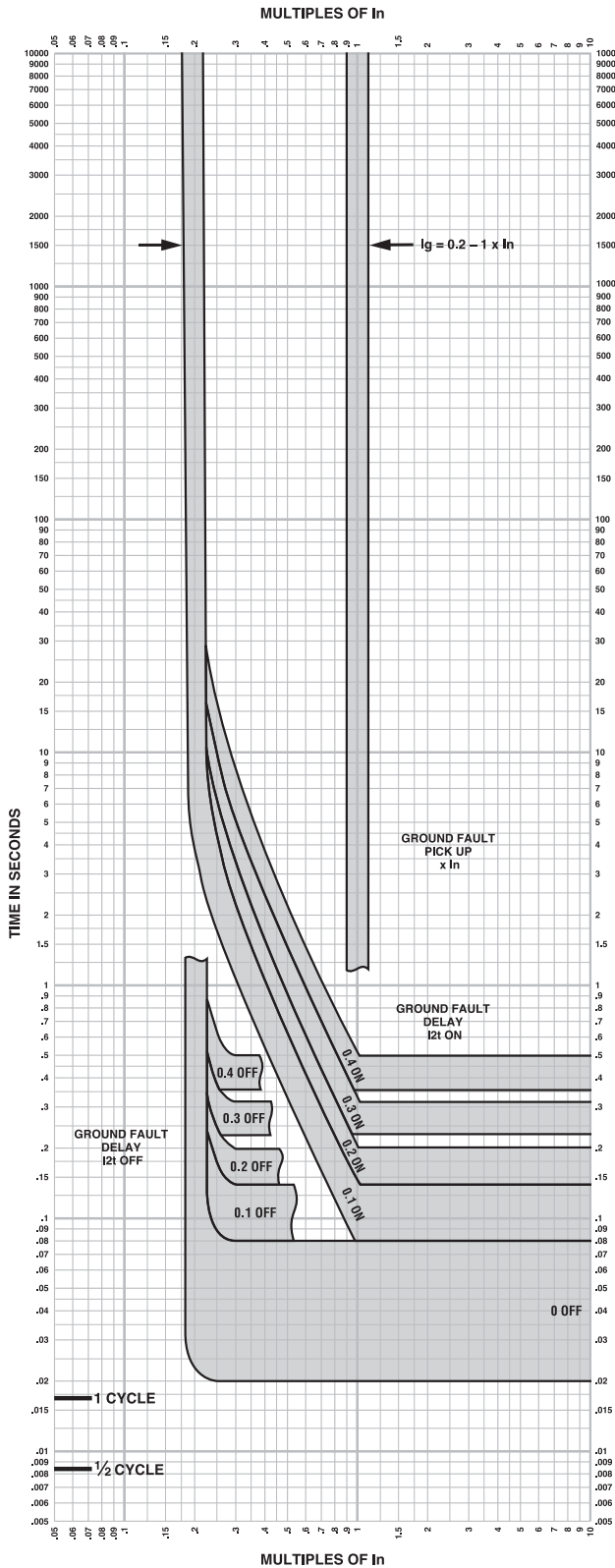

MICROLOGIC™ ELECTRONIC TRIP UNITS Micrologic™ 6.2A or E Ground Fault Trip Curve 100A, 150A H-Frame

The time-current curve information is to be used for application and coordination purposes only.

1. Total clearing times shown include the response times of the trip unit, the circuit breaker opening, and the extinction of the current.

Curves apply from -35°C to +70°C (-31°F to +158°F) ambient temperature.

PowerPact™ H-, J-, and L-Frame Circuit Breakers Trip Curves

Figure 86: Micrologic 6.2A/6.2E Electronic Trip Unit Ground Fault Trip Curve

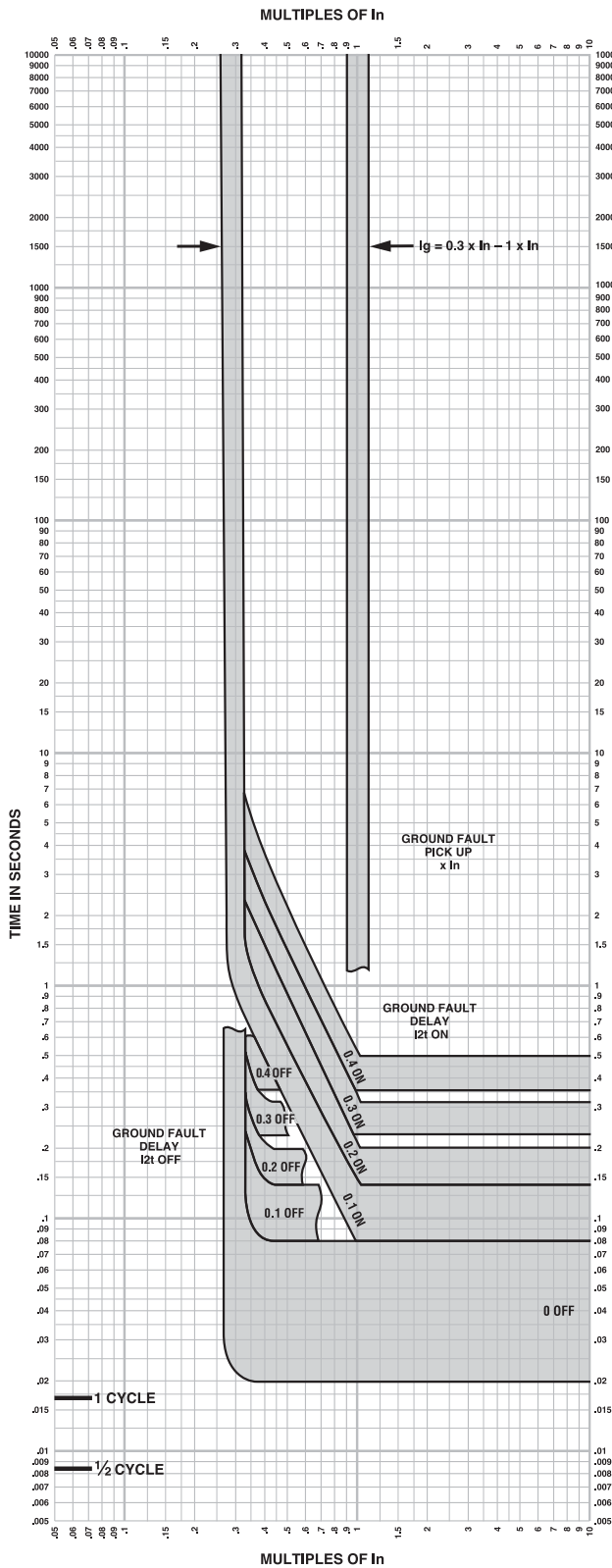

MICROLOGIC™ ELECTRONIC TRIP UNITS Micrologic™ 6.2A or E Ground Fault Trip Curve 60A H-Frame

The time-current curve information is to be used for application and coordination purposes only.

1. Total clearing times shown include the response times of the trip unit, the circuit breaker opening, and the extinction of the current.

Curves apply from -35°C to +70°C (-31°F to +158°F) ambient temperature.

PowerPact™ H-, J-, and L-Frame Circuit Breakers Trip Curves

Figure 87: Micrologic 2.2 M Electronic Trip Unit Overload Trip Curve

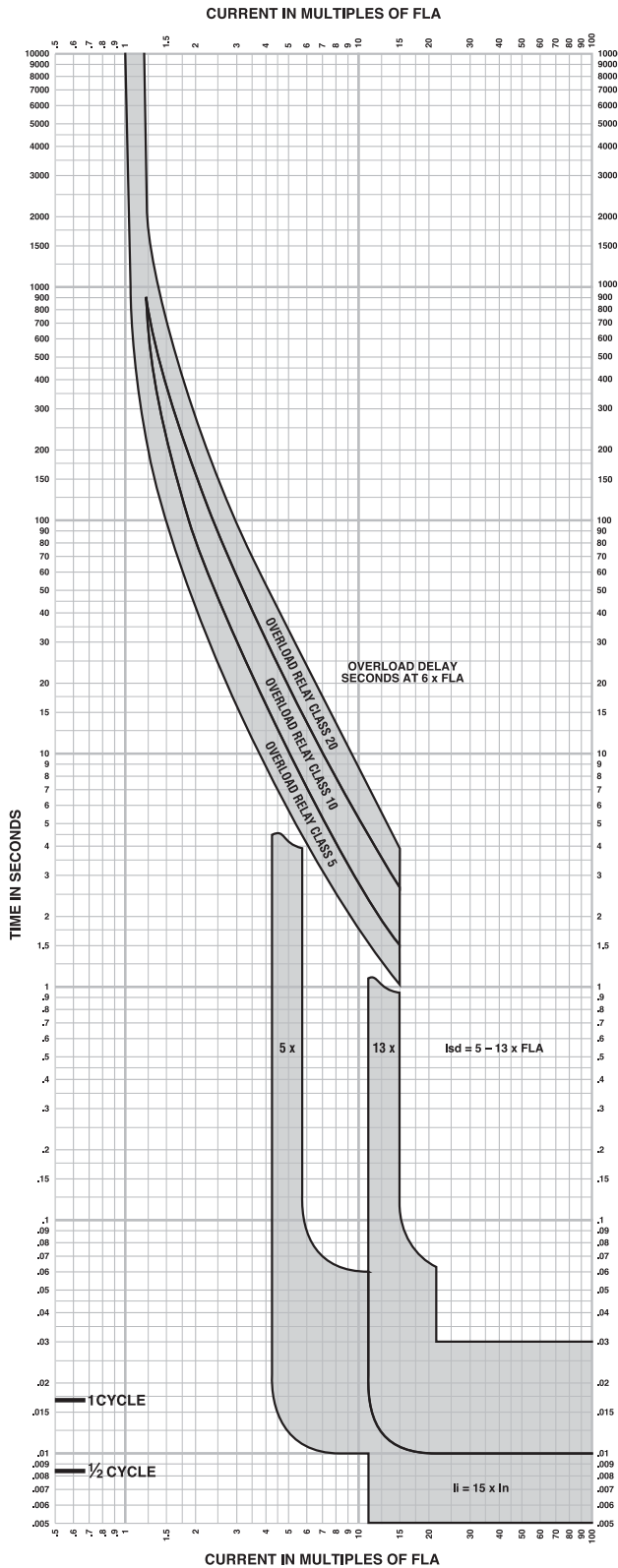

MICROLOGIC™ ELECTRONIC TRIP UNITS Micrologic™ 2.2M Overload Trip Curve 30A, 50A, 100A, 150A H-Frame, 250A J-Frame

The time-current curve information is to be used for application and coordination purposes only.

Notes:

1. If overload still exists past overload relay delay, MCP will open 0.4 seconds later.
 2. Total clearing times shown include the response times of the trip unit, the circuit breaker opening, and the extinction of the current.
 3. Isd minimum and maximum only shown.
 4. $I_i = 15 \times I_n$
 $I_n = 30A, 50A, 100A, 150A, 250A$
MCP will trip <30ms at $15 \times I_n$
- Curves apply from -35°C to $+70^\circ\text{C}$ (-31°F to $+158^\circ\text{F}$) ambient temperature.

J-Frame Electronic Trip Circuit Breakers—250 A Frame

Figure 88: Micrologic 3.2 Electronic Trip Unit Long-Time Trip Curve

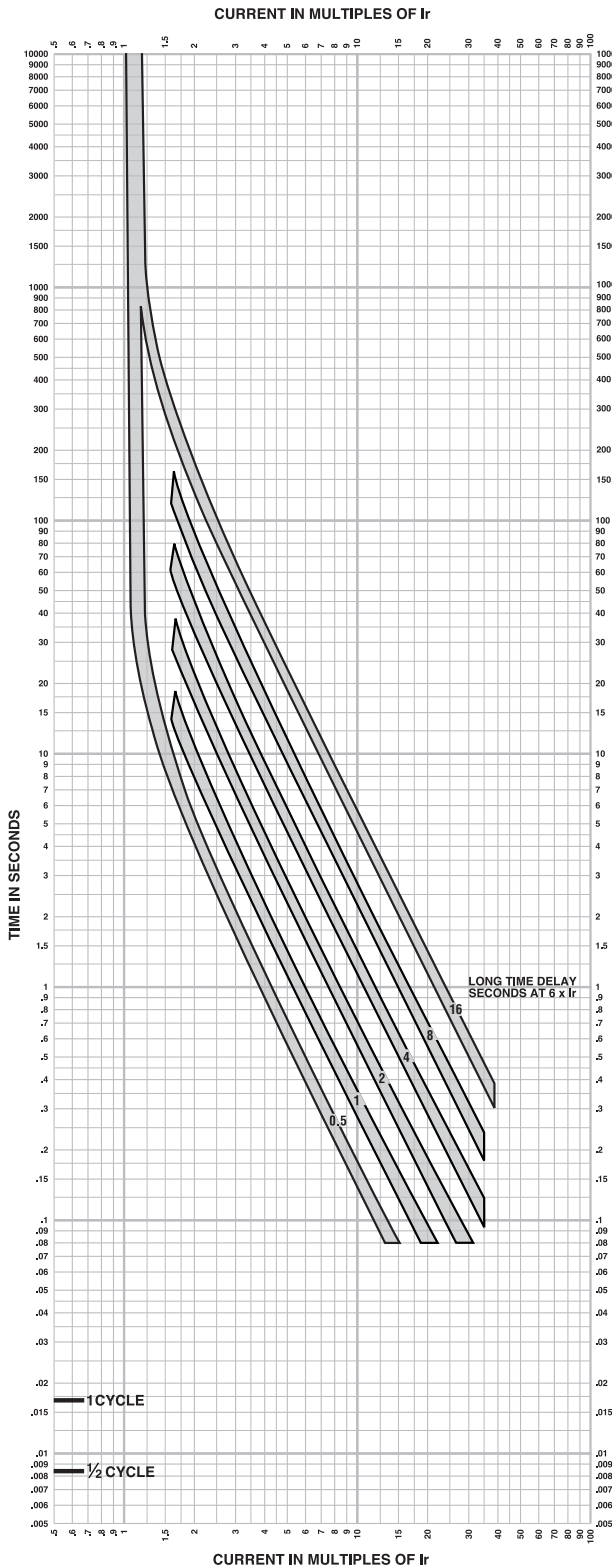

MICROLOGIC™ ELECTRONIC TRIP UNITS
Micrologic™ 3.2 Long Time Trip Curve
250A J-Frame

The time-current curve information is to be used for application and coordination purposes only.

Notes:

1. There is a thermal-imaging effect that can act to shorten the long-time delay. The thermal imaging effect comes into play if a current above the long-time delay pickup value exists for a time and then is cleared by the tripping of a downstream device or the circuit breaker itself. A subsequent overload will cause the circuit breaker to trip in a shorter time than normal. The amount of time delay reduction is inverse to the amount of time that has elapsed since the previous overload. Approximately 20 minutes is required between overloads to completely reset thermal-imaging.
2. Total clearing times shown include the response times of the trip unit, the circuit breaker opening, and the extinction of the current.

Curves apply from -35°C to +70°C (-31°F to +158°F) ambient temperature.

PowerPact™ H-, J-, and L-Frame Circuit Breakers Trip Curves

Figure 89: Micrologic 3.2S Electronic Trip Unit Long Time / Short Time Trip Curve

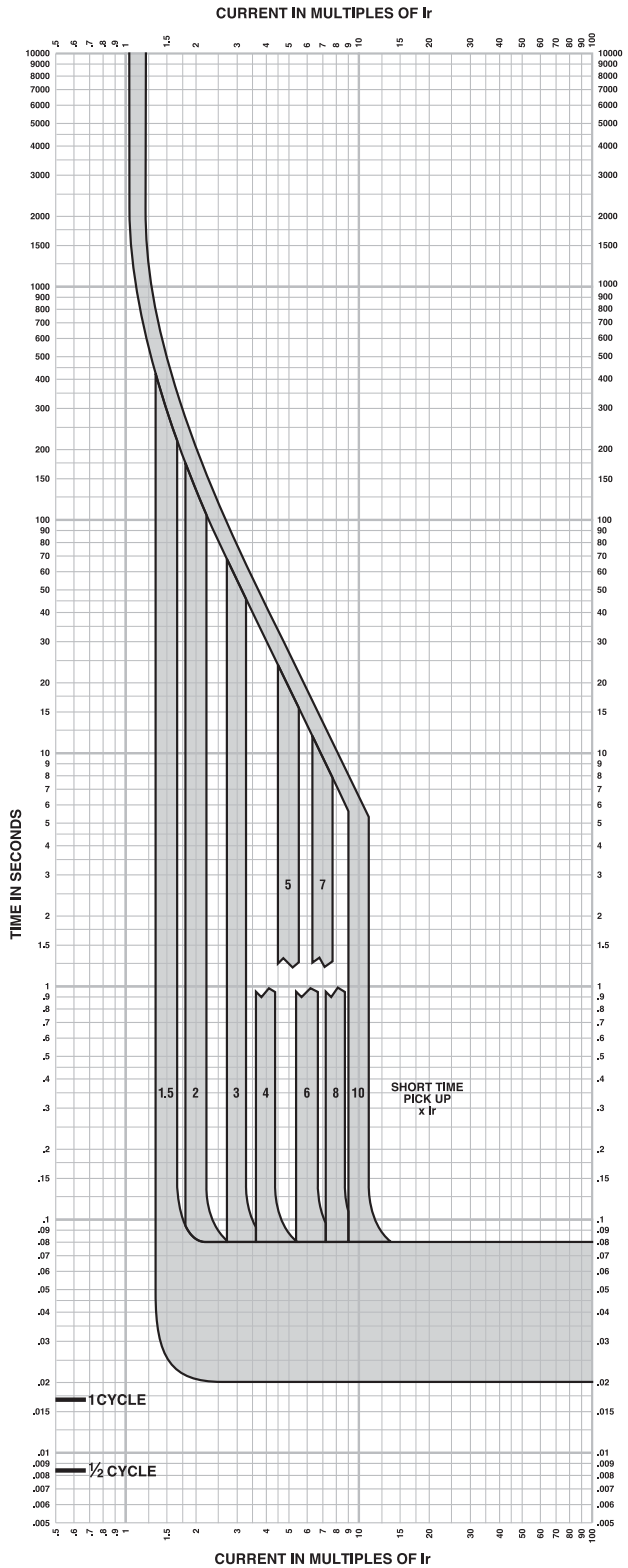

MICROLOGIC™ ELECTRONIC TRIP UNITS Micrologic™ 3.2S Long Time/ Short Time Trip Curve 250A J-Frame

The time-current curve information is to be used for application and coordination purposes only.

Notes:

1. There is a thermal-imaging effect that can act to shorten the long-time delay. The thermal imaging effect comes into play if a current above the long-time delay pickup value exists for a time and then is cleared by the tripping of a downstream device or the circuit breaker itself. A subsequent overload will cause the circuit breaker to trip in a shorter time than normal. The amount of time delay reduction is inverse to the amount of time that has elapsed since the previous overload. Approximately 20 minutes is required between overloads to completely reset thermal-imaging.
2. Total clearing times shown include the response times of the trip unit, the circuit breaker opening, and the extinction of the current.

Curves apply from -35°C to +70°C (-31°F to +158°F) ambient temperature.

PowerPact™ H-, J-, and L-Frame Circuit Breakers Trip Curves

Figure 90: Micrologic 3.2/3.2S/5.2A/5.2E/6.2A/6.2E Electronic Trip Curve Instantaneous Trip Curve

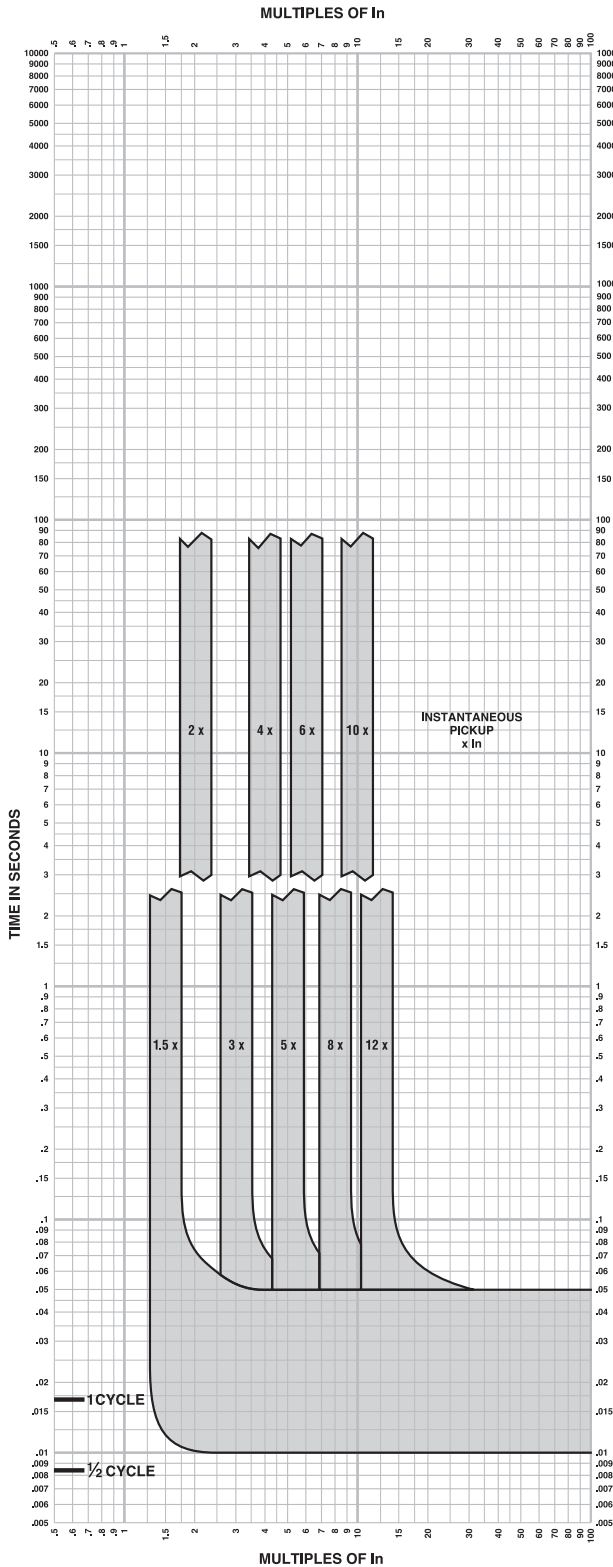

MICROLOGIC™ ELECTRONIC TRIP UNITS Micrologic™ 3.2/3.2S/5.2A or E/6.2A or E Instantaneous Trip Curve 250A J-Frame

The time-current curve information is to be used for application and coordination purposes only.

Notes:

1. There is a thermal-imaging effect that can act to shorten the long-time delay. The thermal imaging effect comes into play if a current above the long-time delay pickup value exists for a time and then is cleared by the tripping of a downstream device or the circuit breaker itself. A subsequent overload will cause the circuit breaker to trip in a shorter time than normal. The amount of time delay reduction is inverse to the amount of time that has elapsed since the previous overload. Approximately 20 minutes is required between overloads to completely reset thermal-imaging.
 2. Total clearing times shown include the response times of the trip unit, the circuit breaker opening, and the extinction of the current.
 3. I_n = Maximum dial setting of I_r .
250A J-Frame: $I_n = 250A = \text{Max } I_r$ setting
- Curves apply from -35°C to $+70^\circ\text{C}$ (-31°F to $+158^\circ\text{F}$) ambient temperature.

PowerPact™ H-, J-, and L-Frame Circuit Breakers Trip Curves

Figure 91: Micrologic 5.2A/5.2E/6.2A/6.2E Electronic Trip Unit Long Time Trip Curve

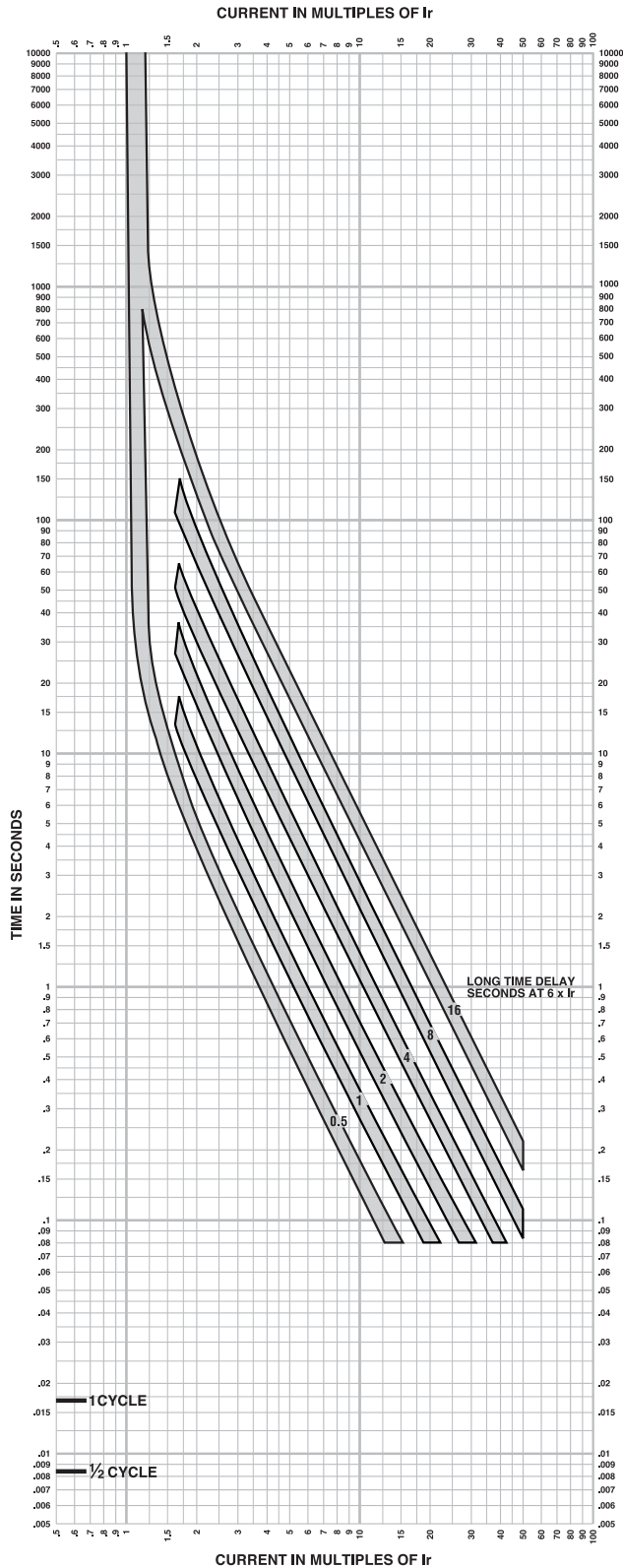

MICROLOGIC™ ELECTRONIC TRIP UNITS Micrologic™ 5.2A or E/6.2A or E Long Time Trip Curve 250A J-Frame

The time-current curve information is to be used for application and coordination purposes only.

Notes:

1. There is a thermal-imaging effect that can act to shorten the long-time delay. The thermal imaging effect comes into play if a current above the long-time delay pickup value exists for a time and then is cleared by the tripping of a downstream device or the circuit breaker itself. A subsequent overload will cause the circuit breaker to trip in a shorter time than normal. The amount of time delay reduction is inverse to the amount of time that has elapsed since the previous overload. Approximately 20 minutes is required between overloads to completely reset thermal-imaging.
2. Total clearing times shown include the response times of the trip unit, the circuit breaker opening, and the extinction of the current.

Curves apply from -35°C to +70°C (-31°F to +158°F) ambient temperature.

PowerPact™ H-, J-, and L-Frame Circuit Breakers Trip Curves

Figure 92: Micrologic 5.2A/5.2E/6.2A/6.2E Electronic Trip Unit Short Time Trip Curve

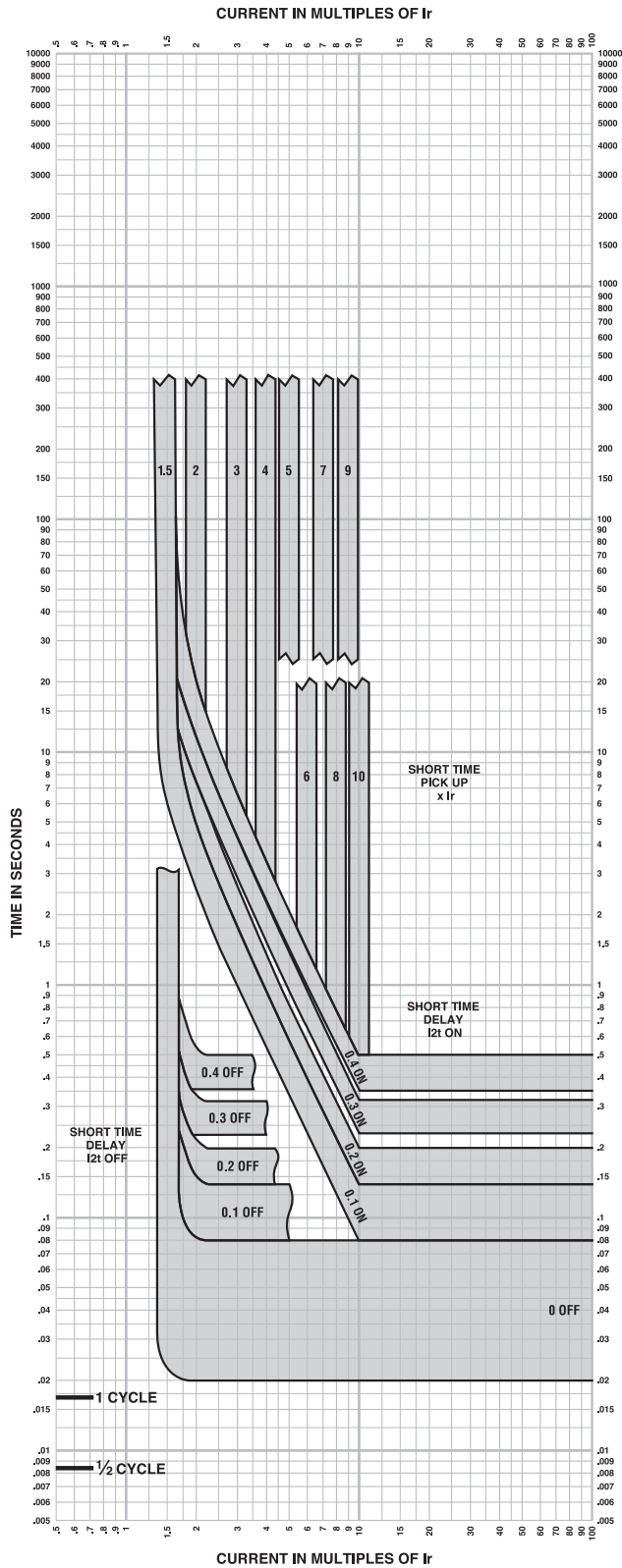

MICROLOGIC™ ELECTRONIC TRIP UNITS Micrologic™ 5.2A or E/6.2A or E Short Time Trip Curve 250A J-Frame

The time-current curve information is to be used for application and coordination purposes only.

Notes:

1. There is a thermal-imaging effect that can act to shorten the long-time delay. The thermal imaging effect comes into play if a current above the long-time delay pickup value exists for a time and then is cleared by the tripping of a downstream device or the circuit breaker itself. A subsequent overload will cause the circuit breaker to trip in a shorter time than normal. The amount of time delay reduction is inverse to the amount of time that has elapsed since the previous overload. Approximately 20 minutes is required between overloads to completely reset thermal-imaging.
2. Total clearing times shown include the response times of the trip unit, the circuit breaker opening, and the extinction of the current.

Curves apply from -35°C to +70°C (-31°F to +158°F) ambient temperature.

PowerPact™ H-, J-, and L-Frame Circuit Breakers Trip Curves

Figure 93: Micrologic 6.2A/6.2E Electronic Trip Unit Ground Fault Trip Curve

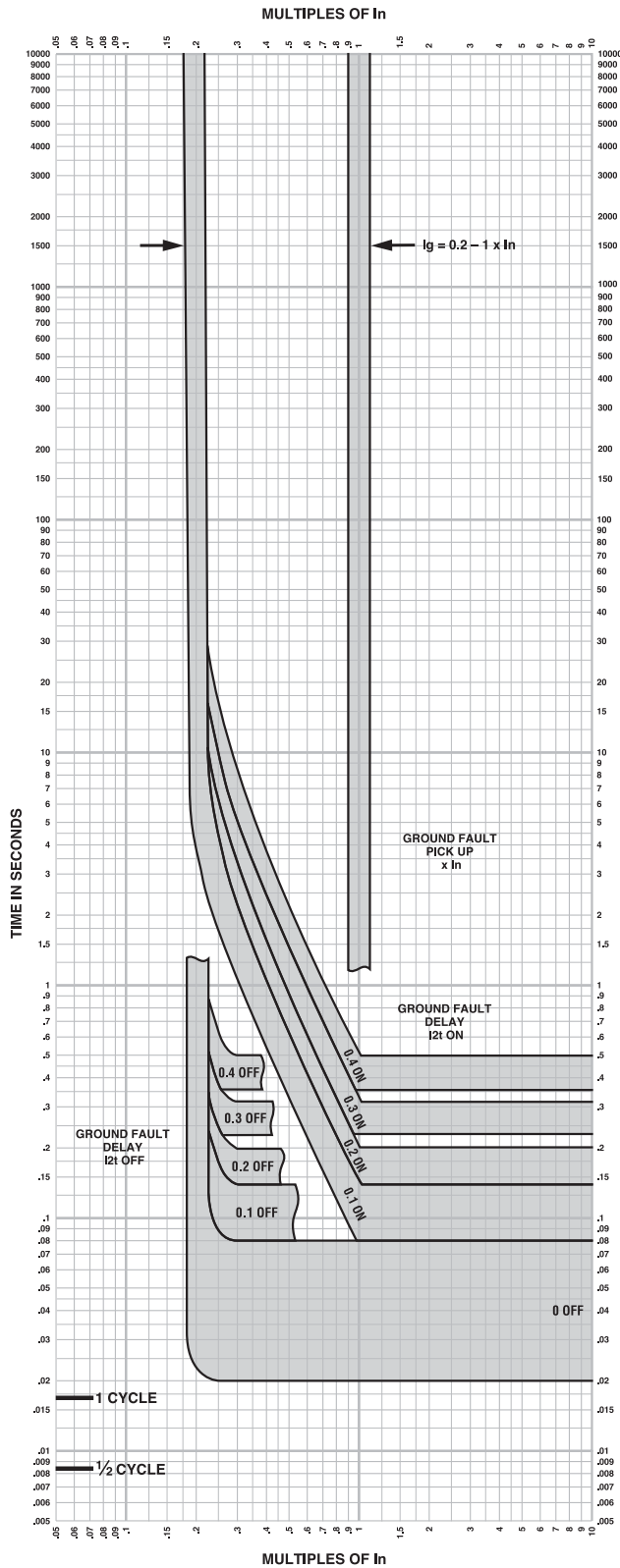

MICROLOGIC™ ELECTRONIC TRIP UNITS Micrologic™ 6.2A or E Ground Fault Trip Curve 250A J-Frame

The time-current curve information is to be used for application and coordination purposes only.

1. Total clearing times shown include the response times of the trip unit, the circuit breaker opening, and the extinction of the current.

Curves apply from -35°C to +70°C (-31°F to +158°F) ambient temperature.

Figure 94: Micrologic 2.2 M Electronic Trip Unit Overload Trip Curve

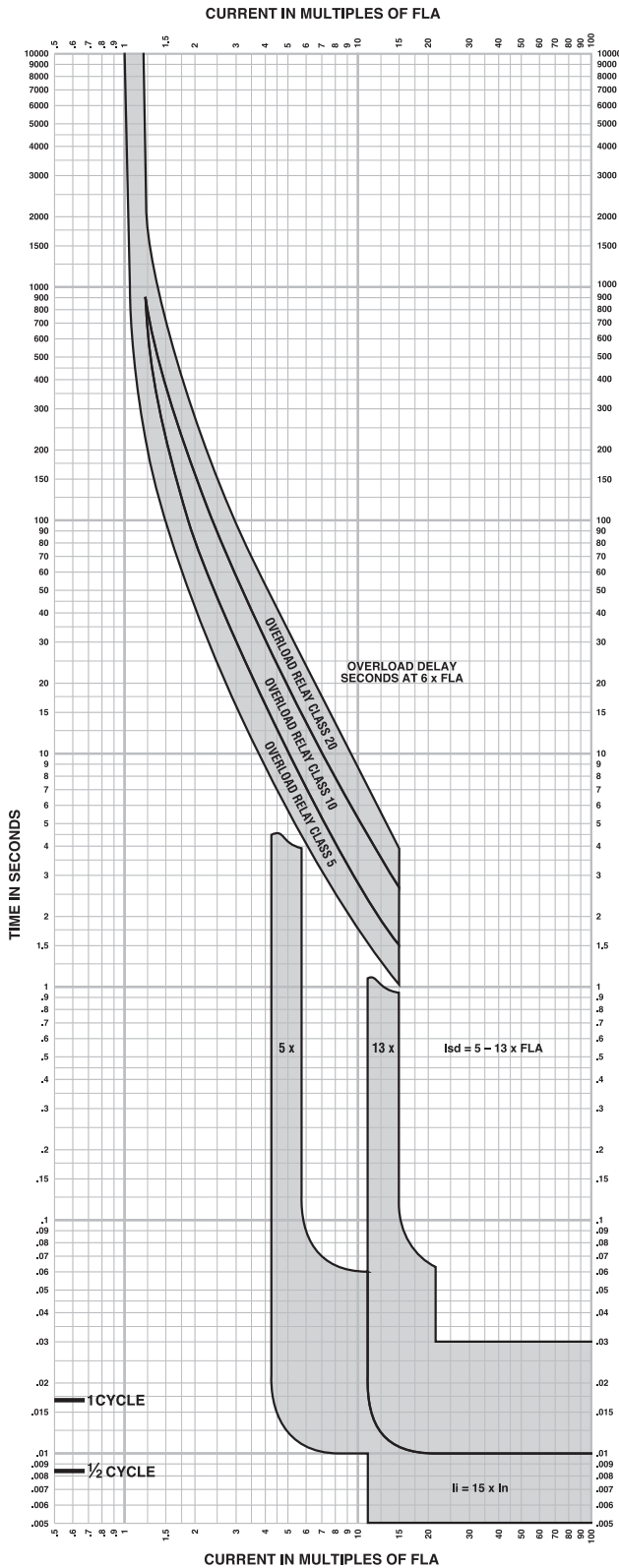

MICROLOGIC™ ELECTRONIC TRIP UNITS
Micrologic™ 2.2M Overload Trip Curve
30A, 50A, 100A, 150A H-Frame, 250A J-Frame

The time-current curve information is to be used for application and coordination purposes only.

Notes:

1. If overload still exists past overload relay delay, MCP will open 0.4 seconds later.
 2. Total clearing times shown include the response times of the trip unit, the circuit breaker opening, and the extinction of the current.
 3. I_{sd} minimum and maximum only shown.
 4. I_i = 15 x I_n
 I_n = 30A, 50A, 100A, 150A, 250A
 MCP will trip <30ms at 15 x I_n
- Curves apply from -35°C to +70°C (-31°F to +158°F) ambient temperature.

PowerPact™ H-, J-, and L-Frame Circuit Breakers Trip Curves

PowerPact L-Frame Electronic Trip Circuit Breakers— 250 A/400 A/600 A Frame

Figure 95: Micrologic 3.3 Electronic Trip Unit Long Time Trip Curve

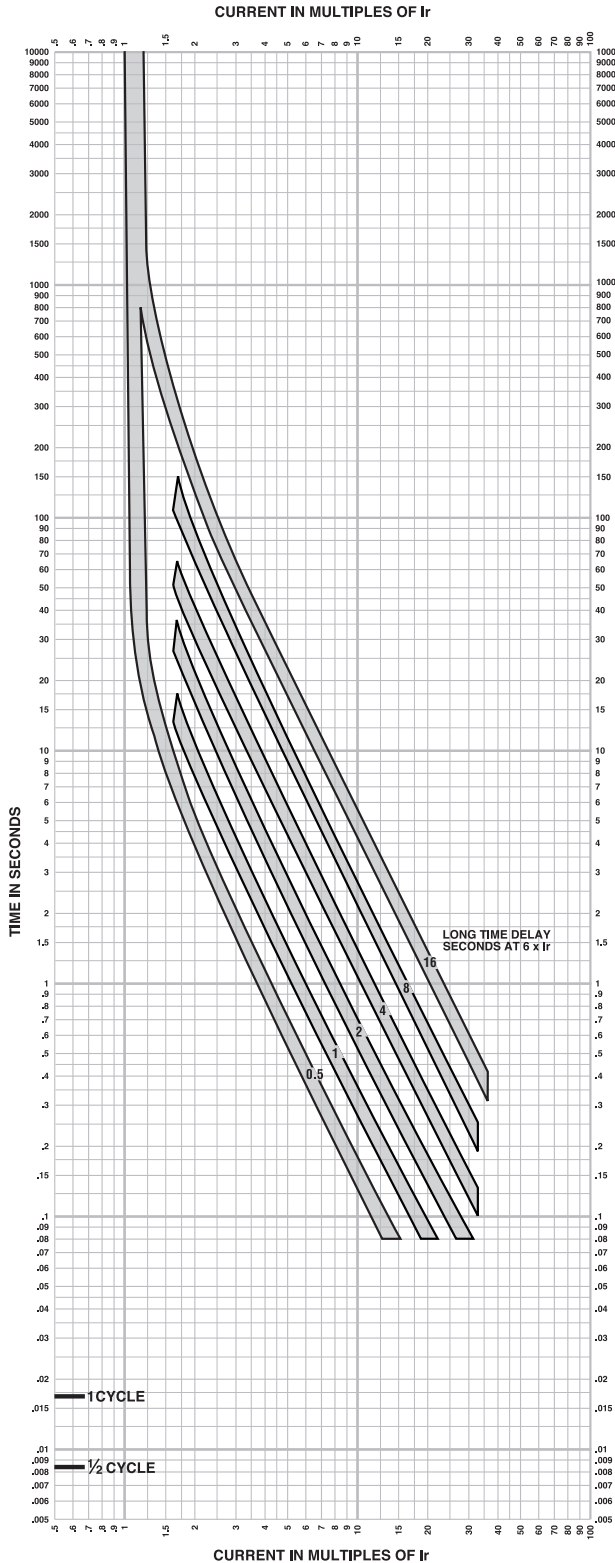

MICROLOGIC™ ELECTRONIC TRIP UNITS Micrologic™ 3.3 Long Time Trip Curve 250A, 400A L-Frame

The time-current curve information is to be used for application and coordination purposes only.

Notes:

1. There is a thermal-imaging effect that can act to shorten the long-time delay. The thermal imaging effect comes into play if a current above the long-time delay pickup value exists for a time and then is cleared by the tripping of a downstream device or the circuit breaker itself. A subsequent overload will cause the circuit breaker to trip in a shorter time than normal. The amount of time delay reduction is inverse to the amount of time that has elapsed since the previous overload. Approximately 20 minutes is required between overloads to completely reset thermal-imaging.
2. Total clearing times shown include the response times of the trip unit, the circuit breaker opening, and the extinction of the current.

Curves apply from -35°C to +70°C (-31°F to +158°F) ambient temperature.

PowerPact™ H-, J-, and L-Frame Circuit Breakers Trip Curves

Figure 96: Micrologic 3.3S Electronic Trip Unit Long Time/Short Time Trip Curve

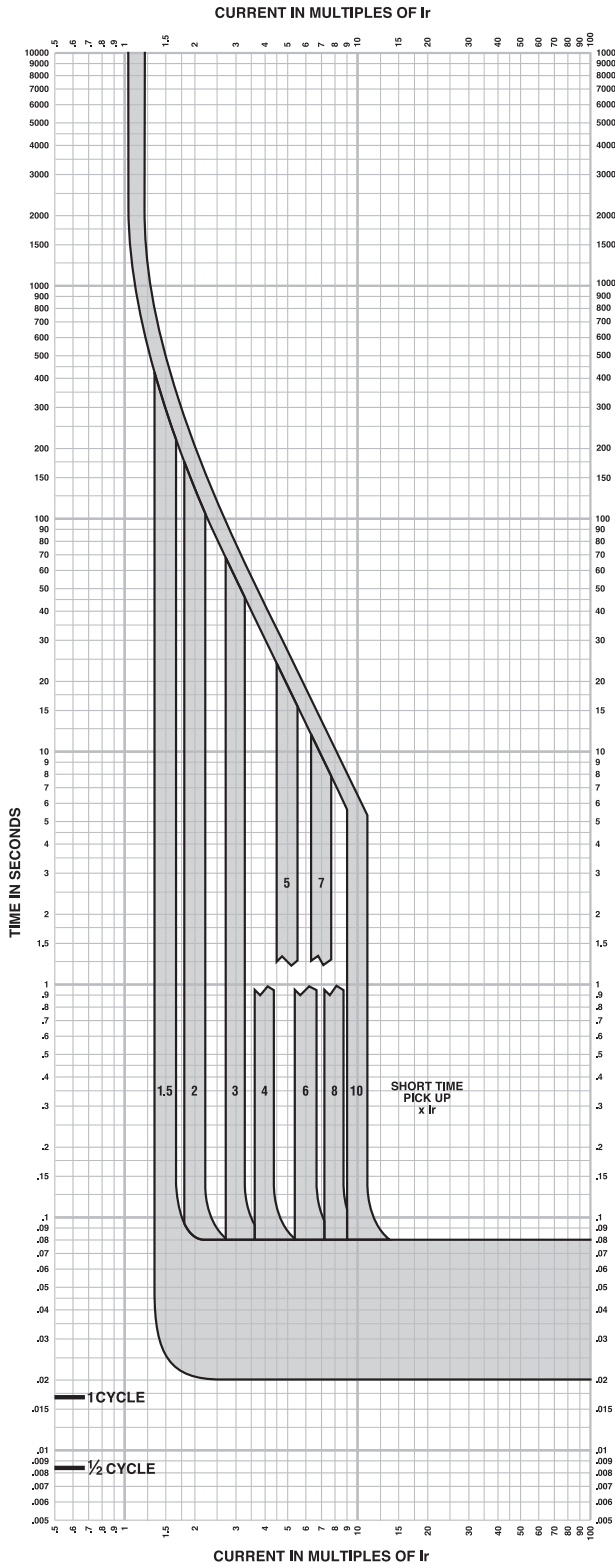

MICROLOGIC™ ELECTRONIC TRIP UNITS Micrologic™ 3.3S Long Time/ Short Time Trip Curve 250A, 400A L-Frame

The time-current curve information is to be used for application and coordination purposes only.

Notes:

1. There is a thermal-imaging effect that can act to shorten the long-time delay. The thermal imaging effect comes into play if a current above the long-time delay pickup value exists for a time and then is cleared by the tripping of a downstream device or the circuit breaker itself. A subsequent overload will cause the circuit breaker to trip in a shorter time than normal. The amount of time delay reduction is inverse to the amount of time that has elapsed since the previous overload. Approximately 20 minutes is required between overloads to completely reset thermal-imaging.
2. Total clearing times shown include the response times of the trip unit, the circuit breaker opening, and the extinction of the current.

Curves apply from -35°C to +70°C (-31°F to +158°F) ambient temperature.

PowerPact™ H-, J-, and L-Frame Circuit Breakers Trip Curves

Figure 97: Micrologic 3.3/3.3S Electronic Trip Unit Instantaneous Trip Curve

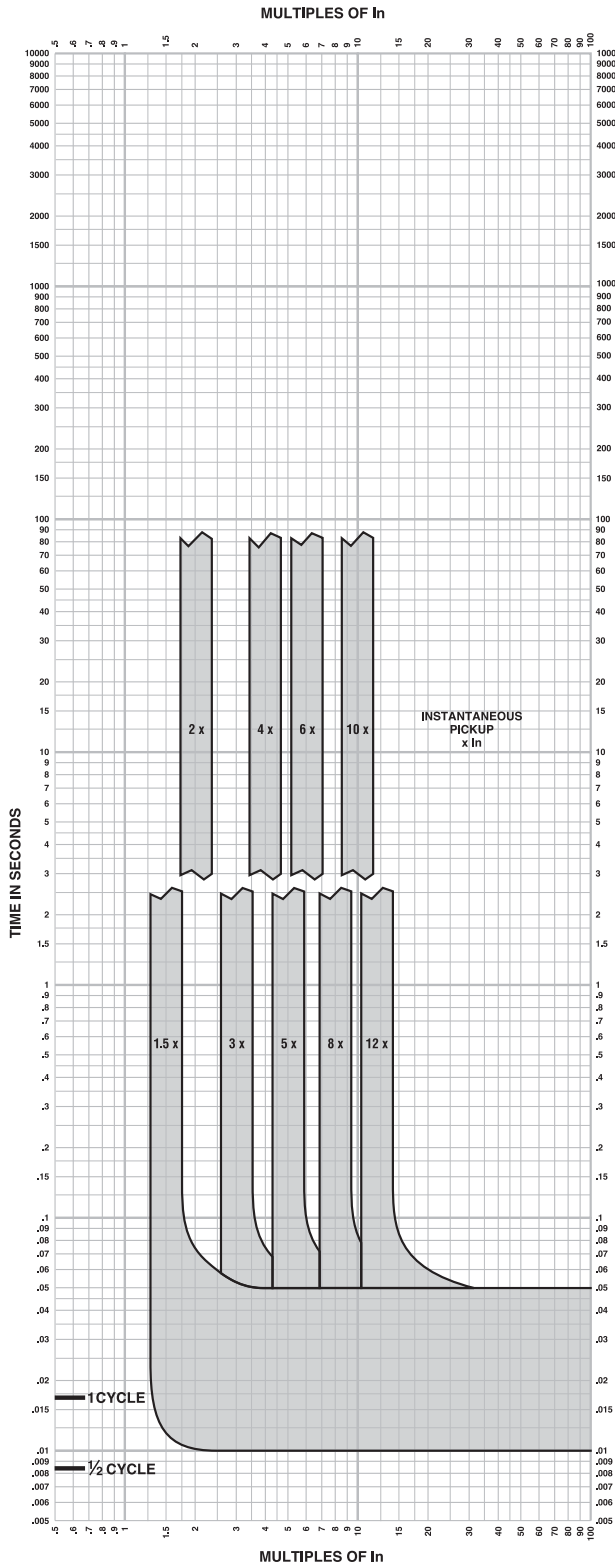

MICROLOGIC™ ELECTRONIC TRIP UNITS Micrologic™ 3.3/3.3S Instantaneous Trip Curve 250A L-Frame

The time-current curve information is to be used for application and coordination purposes only.

Notes:

1. There is a thermal-imaging effect that can act to shorten the long-time delay. The thermal imaging effect comes into play if a current above the long-time delay pickup value exists for a time and then is cleared by the tripping of a downstream device or the circuit breaker itself. A subsequent overload will cause the circuit breaker to trip in a shorter time than normal. The amount of time delay reduction is inverse to the amount of time that has elapsed since the previous overload. Approximately 20 minutes is required between overloads to completely reset thermal-imaging.
 2. Total clearing times shown include the response times of the trip unit, the circuit breaker opening, and the extinction of the current.
 3. In = Maximum dial setting of Ir.
250A L-Frame: In = 250A = Max Ir setting
- Curves apply from -35°C to +70°C (-31°F to +158°F) ambient temperature.

PowerPact™ H-, J-, and L-Frame Circuit Breakers Trip Curves

Figure 98: Micrologic 3.3/3.3S/5.3A/5.3E/6.3A/6.3E Electronic Trip Unit Instantaneous Trip Curve

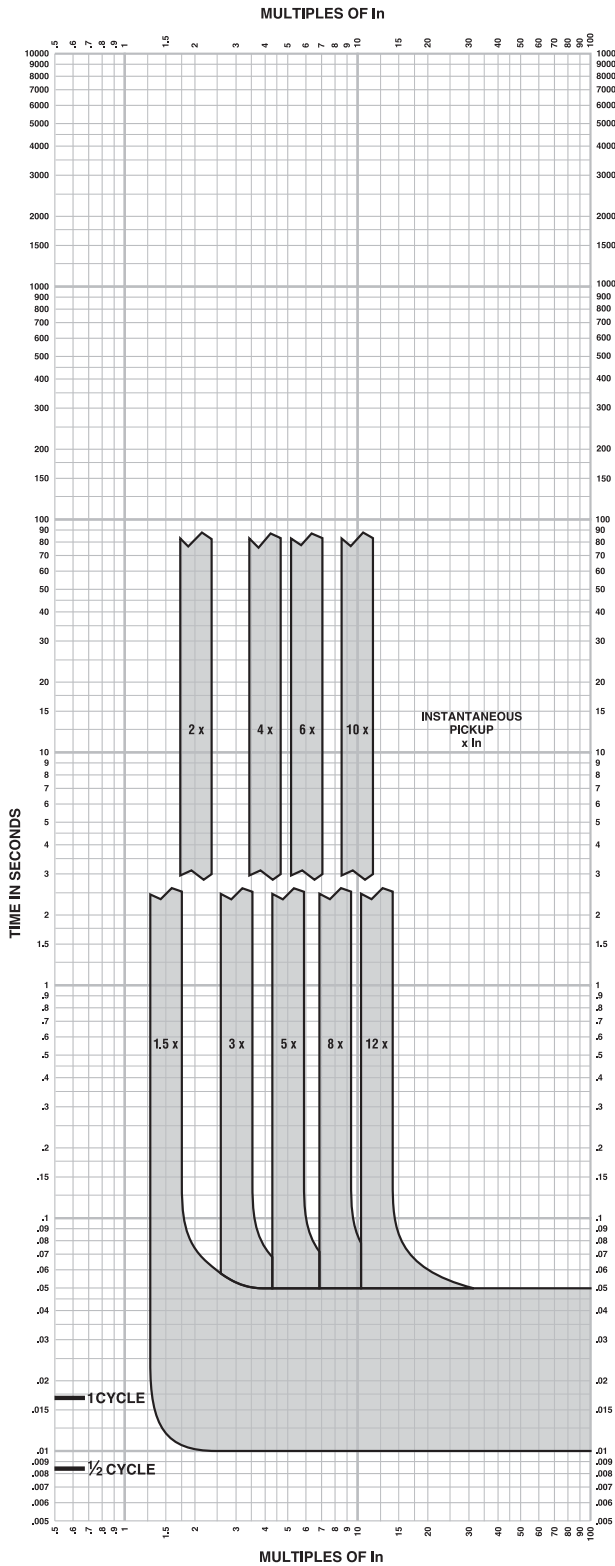

MICROLOGIC™ ELECTRONIC TRIP UNITS Micrologic™ 3.3/3.3S/5.3A or E/6.3A or E Instantaneous Trip Curve 400A L-Frame

The time-current curve information is to be used for application and coordination purposes only.

Notes:

1. There is a thermal-imaging effect that can act to shorten the long-time delay. The thermal imaging effect comes into play if a current above the long-time delay pickup value exists for a time and then is cleared by the tripping of a downstream device or the circuit breaker itself. A subsequent overload will cause the circuit breaker to trip in a shorter time than normal. The amount of time delay reduction is inverse to the amount of time that has elapsed since the previous overload. Approximately 20 minutes is required between overloads to completely reset thermal-imaging.
 2. Total clearing times shown include the response times of the trip unit, the circuit breaker opening, and the extinction of the current.
 3. In = Maximum dial setting of Ir.
400A L-Frame: In = 400A = Max Ir setting
- Curves apply from -35°C to +70°C (-31°F to +158°F) ambient temperature.

PowerPact™ H-, J-, and L-Frame Circuit Breakers Trip Curves

Figure 99: Micrologic 5.3A/5.3E/6.3A/6.3E Electronic Trip Unit Long Time Trip Curve

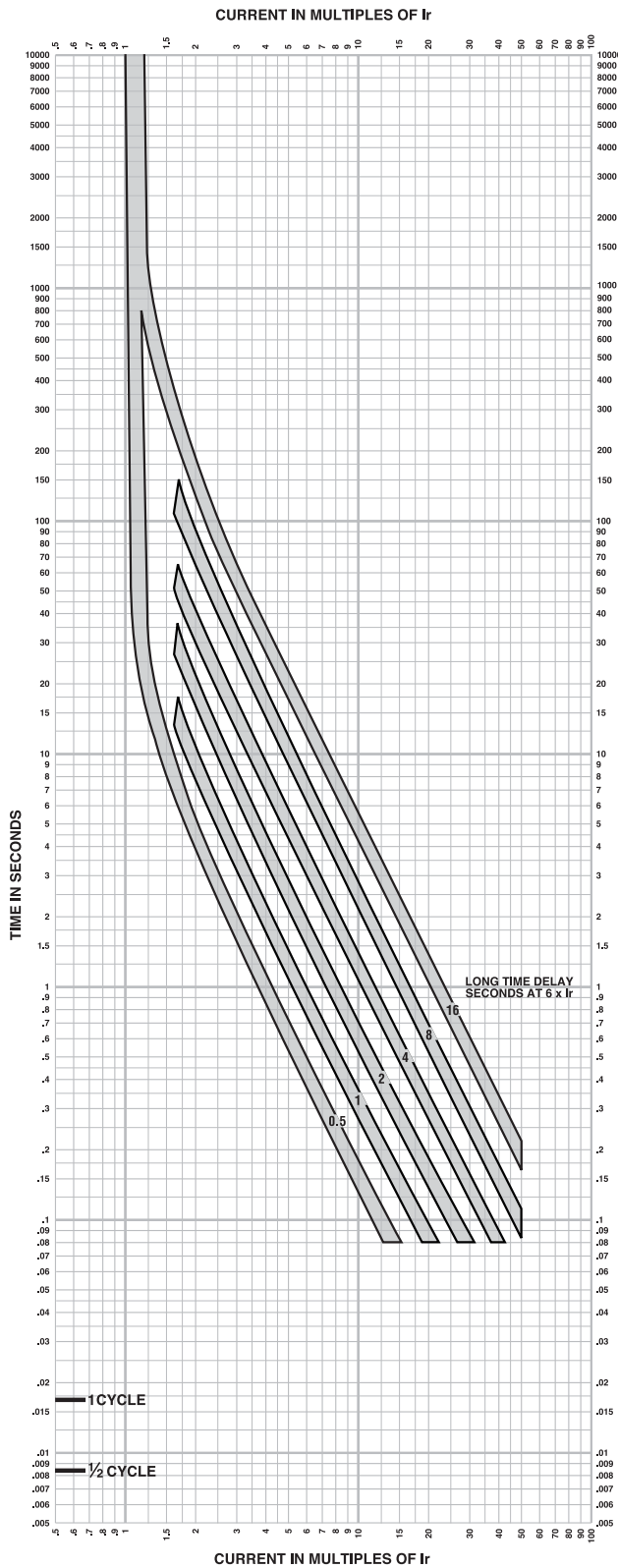

MICROLOGIC™ ELECTRONIC TRIP UNITS Micrologic™ 5.3A or E/6.3A or E Long Time Trip Curve 400A L-Frame

The time-current curve information is to be used for application and coordination purposes only.

Notes:

1. There is a thermal-imaging effect that can act to shorten the long-time delay. The thermal imaging effect comes into play if a current above the long-time delay pickup value exists for a time and then is cleared by the tripping of a downstream device or the circuit breaker itself. A subsequent overload will cause the circuit breaker to trip in a shorter time than normal. The amount of time delay reduction is inverse to the amount of time that has elapsed since the previous overload. Approximately 20 minutes is required between overloads to completely reset thermal-imaging.
2. Total clearing times shown include the response times of the trip unit, the circuit breaker opening, and the extinction of the current.

Curves apply from -35°C to +70°C (-31°F to +158°F) ambient temperature.

PowerPact™ H-, J-, and L-Frame Circuit Breakers Trip Curves

Figure 100: Micrologic 5.3A/5.3E/6.3A/6.3E Electronic Trip Unit Short Time Trip Curve

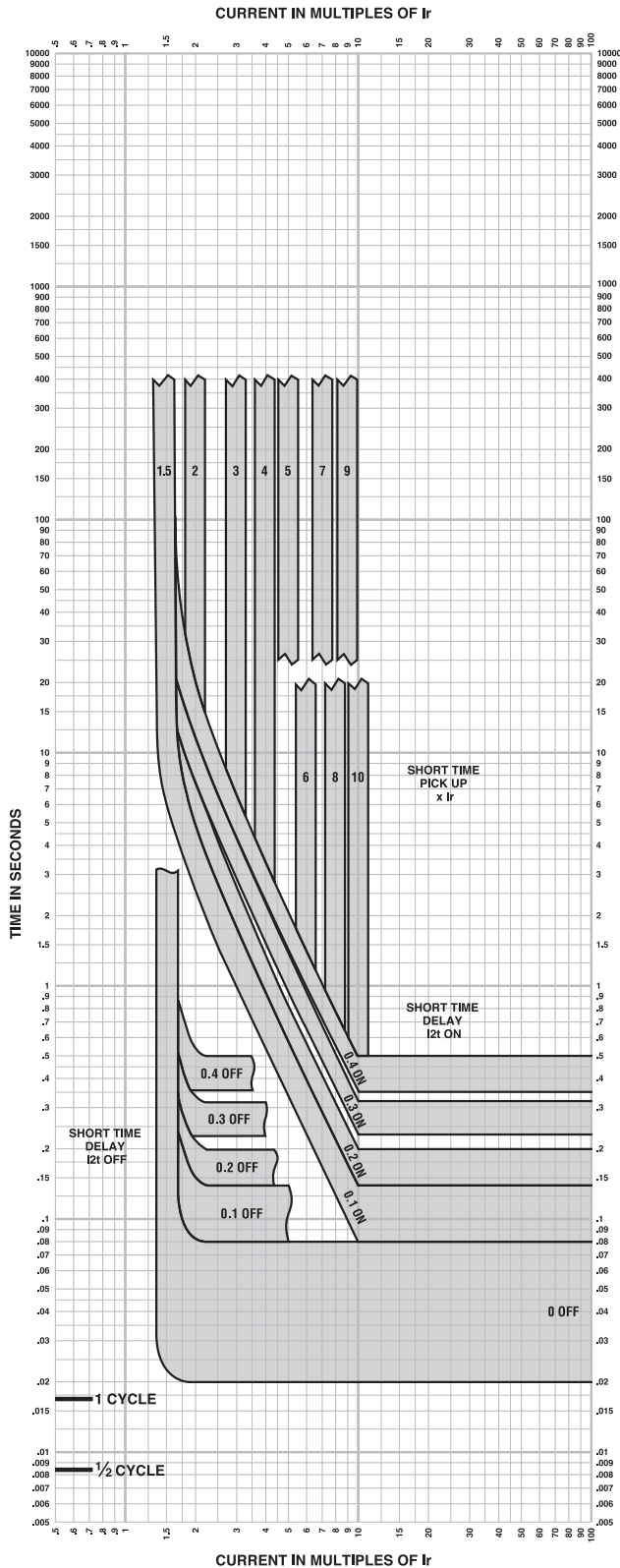

MICROLOGIC™ ELECTRONIC TRIP UNITS Micrologic™ 5.3A or E/6.3A or E Short Time Trip Curve 400A L-Frame

The time-current curve information is to be used for application and coordination purposes only.

Notes:

1. There is a thermal-imaging effect that can act to shorten the long-time delay. The thermal imaging effect comes into play if a current above the long-time delay pickup value exists for a time and then is cleared by the tripping of a downstream device or the circuit breaker itself. A subsequent overload will cause the circuit breaker to trip in a shorter time than normal. The amount of time delay reduction is inverse to the amount of time that has elapsed since the previous overload. Approximately 20 minutes is required between overloads to completely reset thermal-imaging.
2. Total clearing times shown include the response times of the trip unit, the circuit breaker opening, and the extinction of the current.

Curves apply from -35°C to +70°C (-31°F to +158°F) ambient temperature.

PowerPact™ H-, J-, and L-Frame Circuit Breakers Trip Curves

Figure 101: Micrologic 1.3 M Electronic Trip Unit Instantaneous Trip Curve

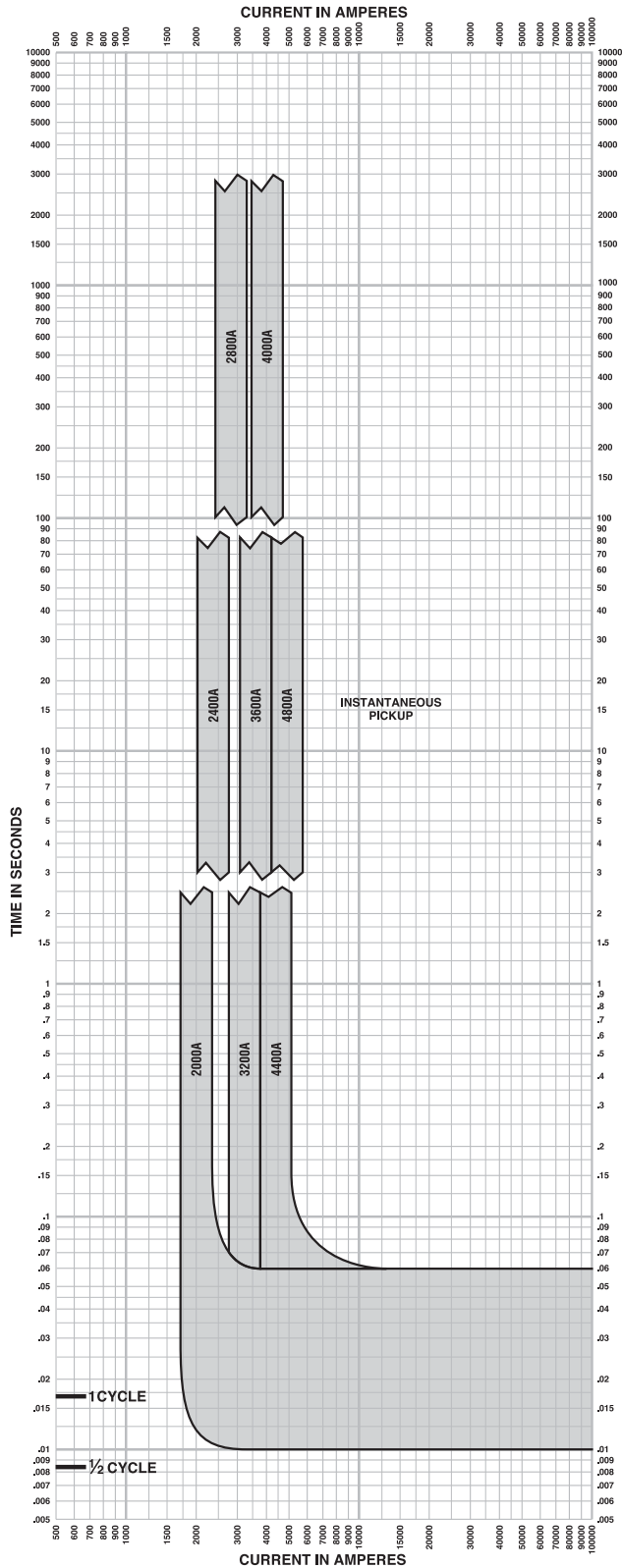

MICROLOGIC™ ELECTRONIC TRIP UNITS Micrologic™ 1.3M Instantaneous Trip Curve 400A L-Frame

The time-current curve information is to be used for application and coordination purposes only.

Notes:

1. Total clearing times shown include the response times of the trip unit, the circuit breaker opening, and the extinction of the current.

Curves apply from -35°C to +70°C (-31°F to +158°F) ambient temperature.

PowerPact™ H-, J-, and L-Frame Circuit Breakers Trip Curves

Figure 102: Micrologic 2.3 M Electronic Trip Unit Overload Trip Curve

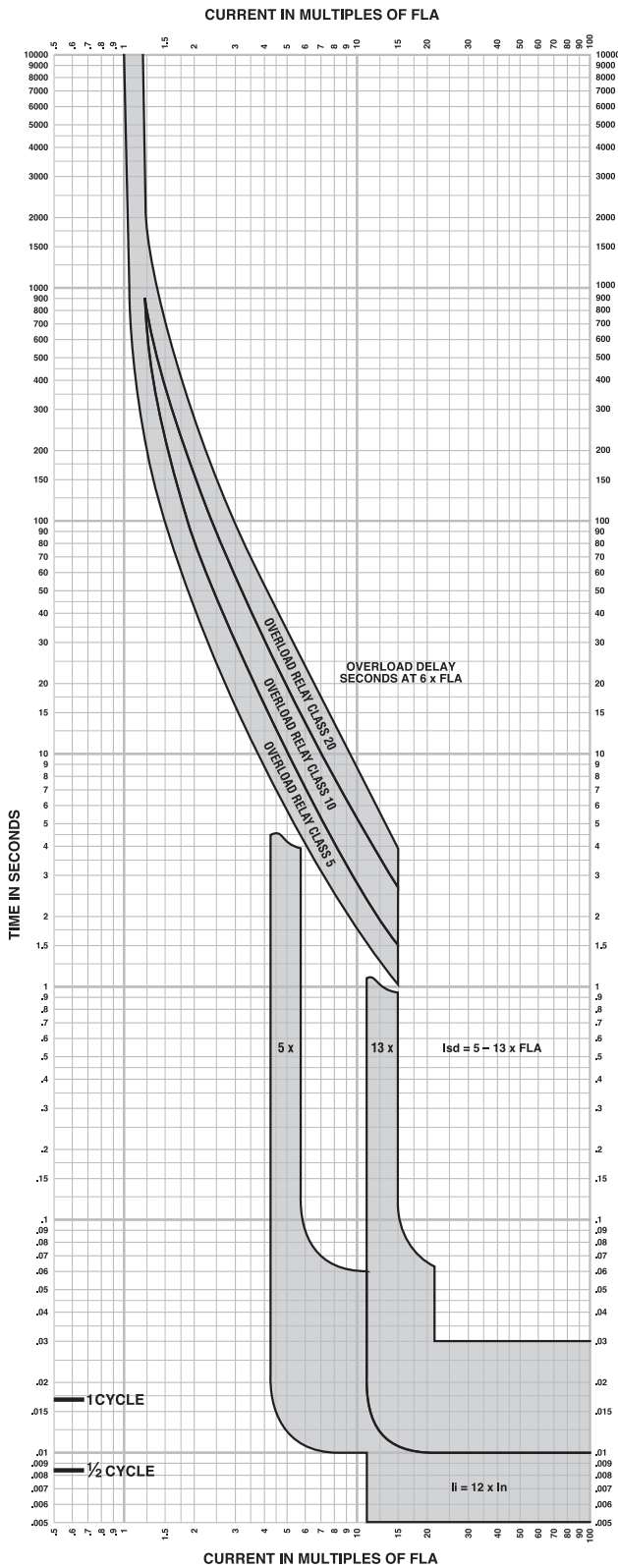

MICROLOGIC™ ELECTRONIC TRIP UNITS Micrologic™ 2.3M Overload Trip Curve 400A, 600A L-Frame

The time-current curve information is to be used for application and coordination purposes only.

Notes:

1. If overload still exists past overload relay delay, MCP will open 0.4 seconds later.
 2. Total clearing times shown include the response times of the trip unit, the circuit breaker opening, and the extinction of the current.
 3. Isd minimum and maximum only shown.
 4. $I_i = 12 \times I_n$
 $I_n = 400A, 600A$
MCP will trip <30ms at $12 \times I_n$
- Curves apply from -35°C to $+70^\circ\text{C}$ (-31°F to $+158^\circ\text{F}$) ambient temperature.

PowerPact™ H-, J-, and L-Frame Circuit Breakers Trip Curves

Figure 103: Micrologic 3.3 Electronic Trip Unit Long Time Trip Curve

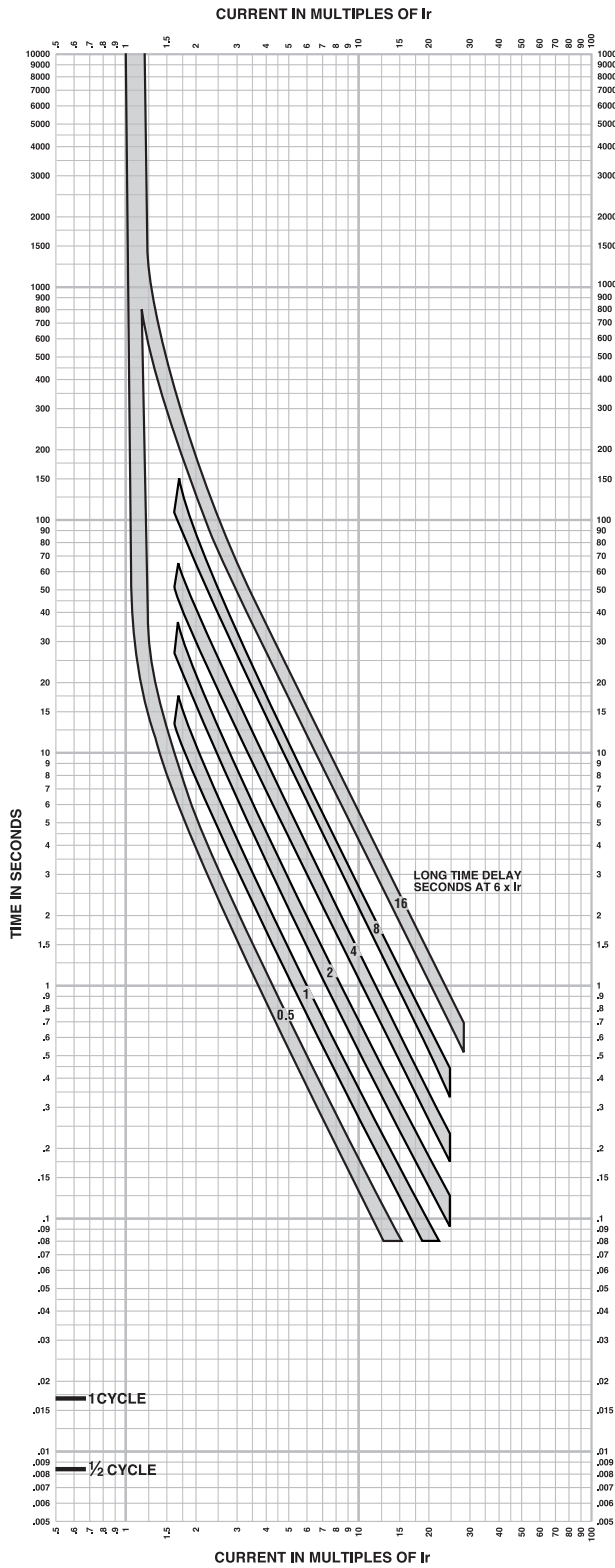

MICROLOGIC™ ELECTRONIC TRIP UNITS Micrologic™ 3.3 Long Time Trip Curve 600A L-Frame

The time-current curve information is to be used for application and coordination purposes only.

Notes:

1. There is a thermal-imaging effect that can act to shorten the long-time delay. The thermal imaging effect comes into play if a current above the long-time delay pickup value exists for a time and then is cleared by the tripping of a downstream device or the circuit breaker itself. A subsequent overload will cause the circuit breaker to trip in a shorter time than normal. The amount of time delay reduction is inverse to the amount of time that has elapsed since the previous overload. Approximately 20 minutes is required between overloads to completely reset thermal-imaging.
2. Total clearing times shown include the response times of the trip unit, the circuit breaker opening, and the extinction of the current.

Curves apply from -35°C to $+70^{\circ}\text{C}$ (-31°F to $+158^{\circ}\text{F}$) ambient temperature.

PowerPact™ H-, J-, and L-Frame Circuit Breakers Trip Curves

Figure 104: Micrologic 3.3S Electronic Trip Unit Long Time/Short Time Trip Curve

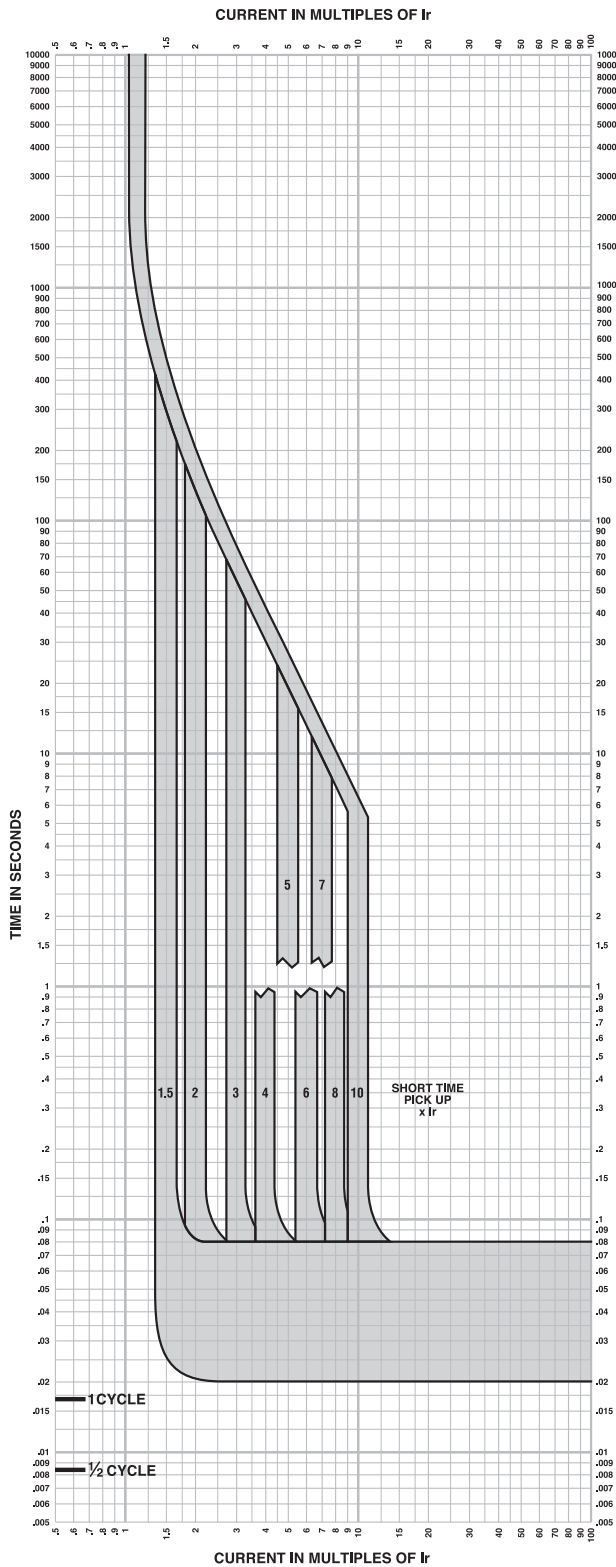

MICROLOGIC™ ELECTRONIC TRIP UNITS Micrologic™ 3.3S Long Time/ Short Time Trip Curve 600A L-Frame

The time-current curve information is to be used for application and coordination purposes only.

Notes:

1. There is a thermal-imaging effect that can act to shorten the long-time delay. The thermal imaging effect comes into play if a current above the long-time delay pickup value exists for a time and then is cleared by the tripping of a downstream device or the circuit breaker itself. A subsequent overload will cause the circuit breaker to trip in a shorter time than normal. The amount of time delay reduction is inverse to the amount of time that has elapsed since the previous overload. Approximately 20 minutes is required between overloads to completely reset thermal-imaging.
2. Total clearing times shown include the response times of the trip unit, the circuit breaker opening, and the extinction of the current.

Curves apply from -35°C to +70°C (-31°F to +158°F) ambient temperature.

PowerPact™ H-, J-, and L-Frame Circuit Breakers Trip Curves

Figure 105: Micrologic 3.3/3.3S/5.3A/5.3E/6.3A/6.3E Electronic Trip Unit Instantaneous Trip Curve

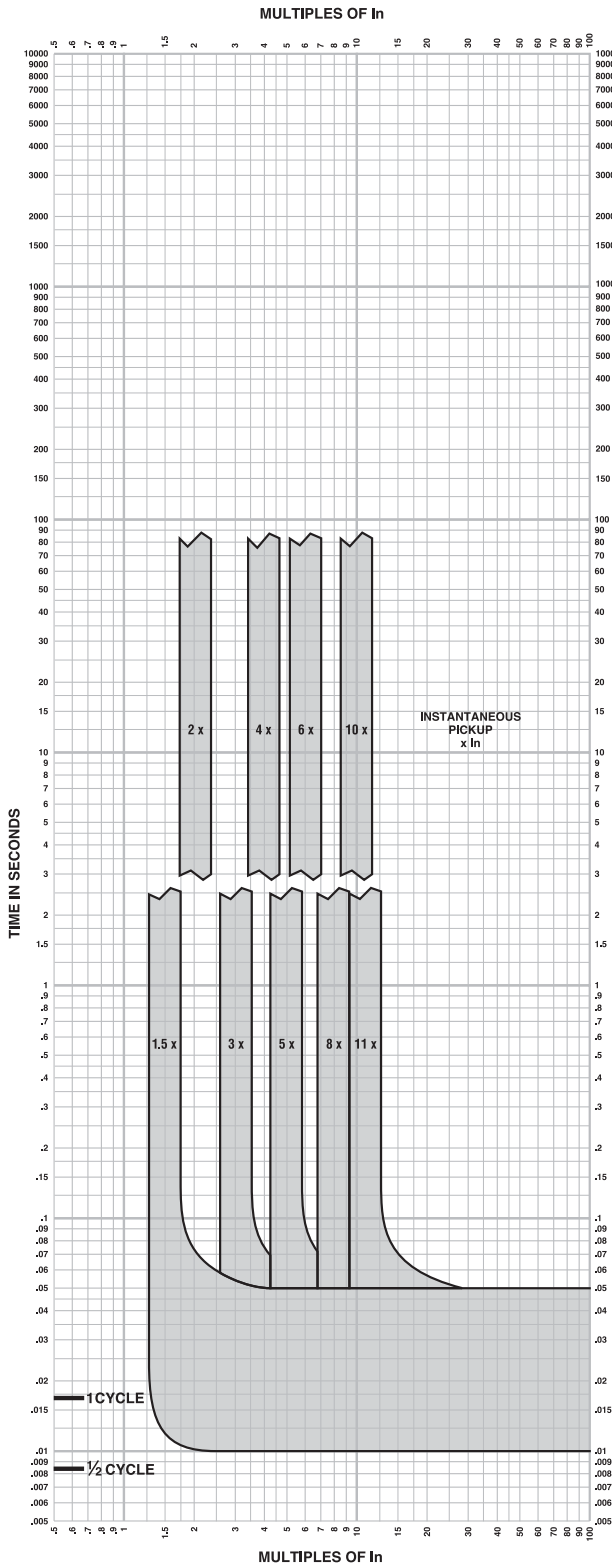

MICROLOGIC™ ELECTRONIC TRIP UNITS Micrologic™ 3.3/3.3S/5.3A or E/6.3A or E Instantaneous Trip Curve 600A L-Frame

The time-current curve information is to be used for application and coordination purposes only.

Notes:

1. There is a thermal-imaging effect that can act to shorten the long-time delay. The thermal imaging effect comes into play if a current above the long-time delay pickup value exists for a time and then is cleared by the tripping of a downstream device or the circuit breaker itself. A subsequent overload will cause the circuit breaker to trip in a shorter time than normal. The amount of time delay reduction is inverse to the amount of time that has elapsed since the previous overload. Approximately 20 minutes is required between overloads to completely reset thermal-imaging.
 2. Total clearing times shown include the response times of the trip unit, the circuit breaker opening, and the extinction of the current.
 3. I_n = Maximum dial setting of I_r .
600A L-Frame: $I_n = 600A = \text{Max } I_r \text{ setting}$
- Curves apply from -35°C to $+70^\circ\text{C}$ (-31°F to $+158^\circ\text{F}$) ambient temperature.

PowerPact™ H-, J-, and L-Frame Circuit Breakers Trip Curves

Figure 106: Micrologic 5.3A/5.3E/6.3A/6.3E Electronic Trip Unit Long Time Trip Curve

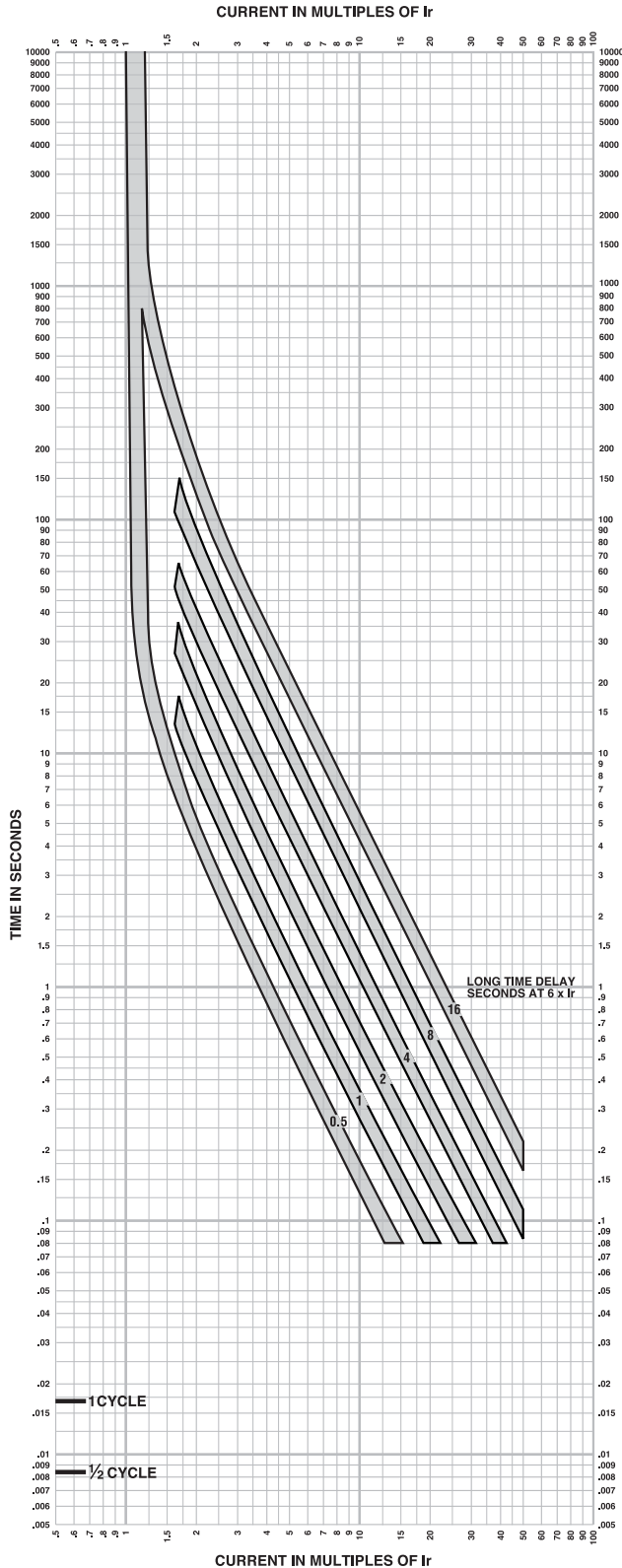

MICROLOGIC™ ELECTRONIC TRIP UNITS Micrologic™ 5.3A or E/6.3A or E Long Time Trip Curve 600A L-Frame

The time-current curve information is to be used for application and coordination purposes only.

Notes:

1. There is a thermal-imaging effect that can act to shorten the long-time delay. The thermal imaging effect comes into play if a current above the long-time delay pickup value exists for a time and then is cleared by the tripping of a downstream device or the circuit breaker itself. A subsequent overload will cause the circuit breaker to trip in a shorter time than normal. The amount of time delay reduction is inverse to the amount of time that has elapsed since the previous overload. Approximately 20 minutes is required between overloads to completely reset thermal-imaging.
2. Total clearing times shown include the response times of the trip unit, the circuit breaker opening, and the extinction of the current.

Curves apply from -35°C to +70°C (-31°F to +158°F) ambient temperature.

PowerPact™ H-, J-, and L-Frame Circuit Breakers Trip Curves

Figure 107: Micrologic 5.3A/5.3E/6.3A/6.3E Electronic Trip Unit Short Time Trip Curve

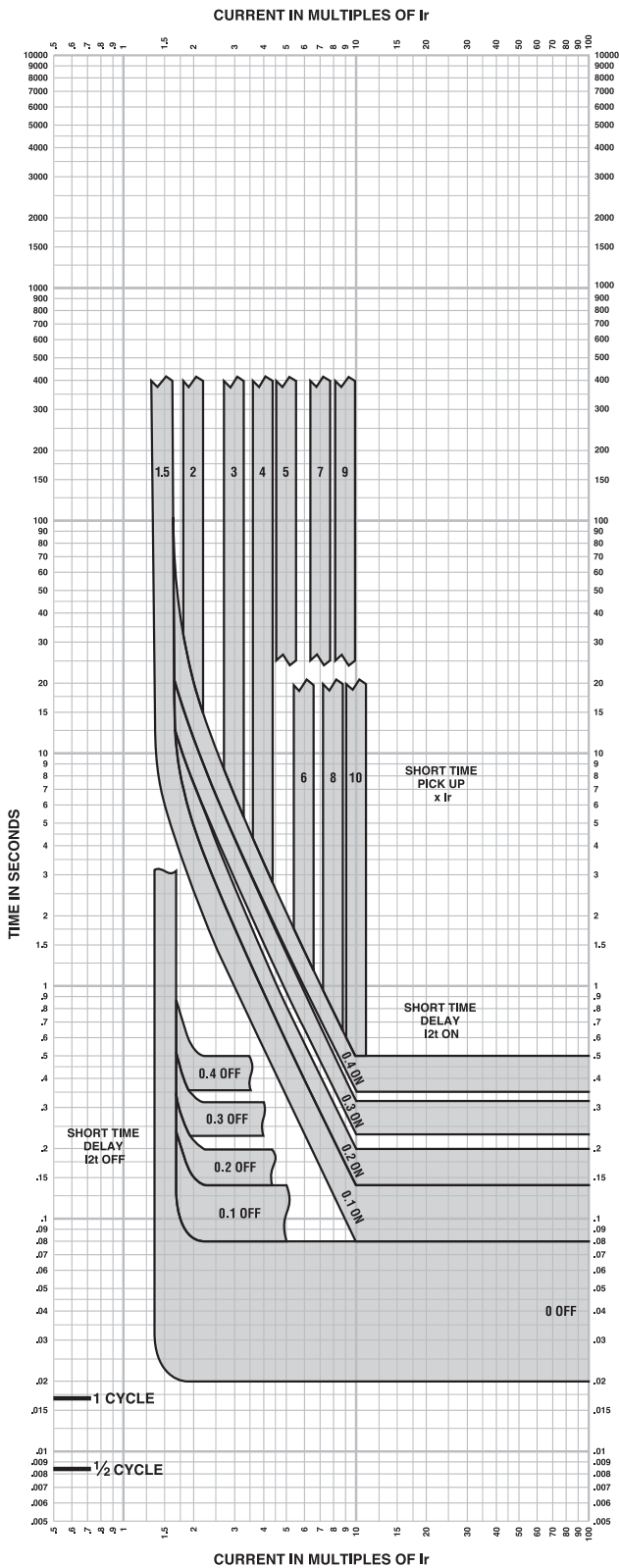

MICROLOGIC™ ELECTRONIC TRIP UNITS Micrologic™ 5.3A or E/6.3A or E Short Time Trip Curve 600A L-Frame

The time-current curve information is to be used for application and coordination purposes only.

Notes:

1. There is a thermal-imaging effect that can act to shorten the long-time delay. The thermal imaging effect comes into play if a current above the long-time delay pickup value exists for a time and then is cleared by the tripping of a downstream device or the circuit breaker itself. A subsequent overload will cause the circuit breaker to trip in a shorter time than normal. The amount of time delay reduction is inverse to the amount of time that has elapsed since the previous overload. Approximately 20 minutes is required between overloads to completely reset thermal-imaging.
2. Total clearing times shown include the response times of the trip unit, the circuit breaker opening, and the extinction of the current.

Curves apply from -35°C to +70°C (-31°F to +158°F) ambient temperature.

PowerPact™ H-, J-, and L-Frame Circuit Breakers Trip Curves

Figure 108: Micrologic 1.3 M Electronic Trip Unit Instantaneous Trip Curve

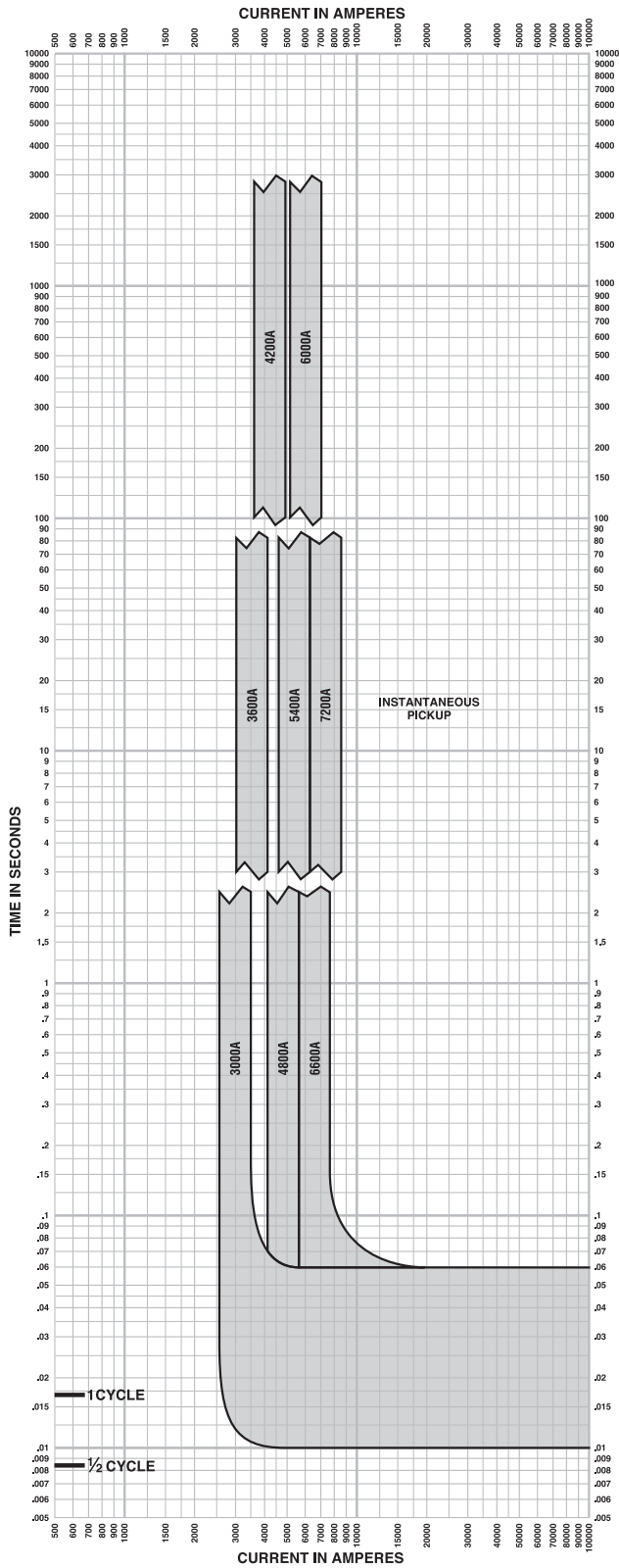

MICROLOGIC™ ELECTRONIC TRIP UNITS Micrologic™ 1.3M Instantaneous Trip Curve 600A L-Frame

The time-current curve information is to be used for application and coordination purposes only.

Notes:

1. Total clearing times shown include the response times of the trip unit, the circuit breaker opening, and the extinction of the current.

Curves apply from -35°C to +70°C (-31°F to +158°F) ambient temperature.

PowerPact™ H-, J-, and L-Frame Circuit Breakers Trip Curves

Figure 109: L-Frame 600 A Typical Peak Let-Through Curves

ELECTRONIC MOLDED CASE CIRCUIT BREAKERS
POWERPACT™ L-FRAME CURRENT LIMITING CIRCUIT BREAKERS
 600 A FRAME AT 240, 480 AND 600 V, 3Ø
 LD, LG, LJ, LL AND LR 250–600 A
 PEAK LET-THROUGH CURRENT I_p

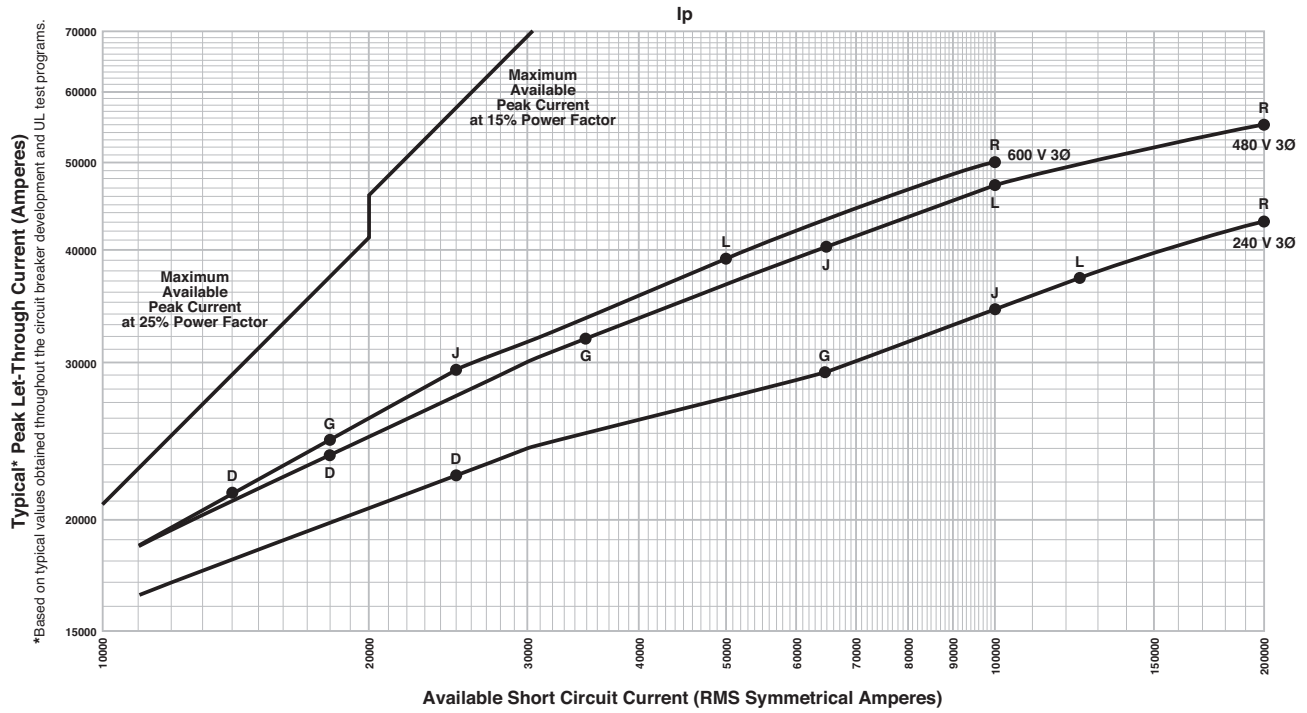

PowerPact™ H-, J-, and L-Frame Circuit Breakers Trip Curves

Figure 110: L-Frame 600 A Typical I²t Let-Through Curves

ELECTRONIC MOLDED CASE CIRCUIT BREAKERS
POWERPACT™ L-FRAME CURRENT LIMITING CIRCUIT BREAKERS
 600 A FRAME AT 240, 480 AND 600 V, 3Ø
 LD, LG, LJ, LL AND LR 250–600 A
 LET-THROUGH I²t

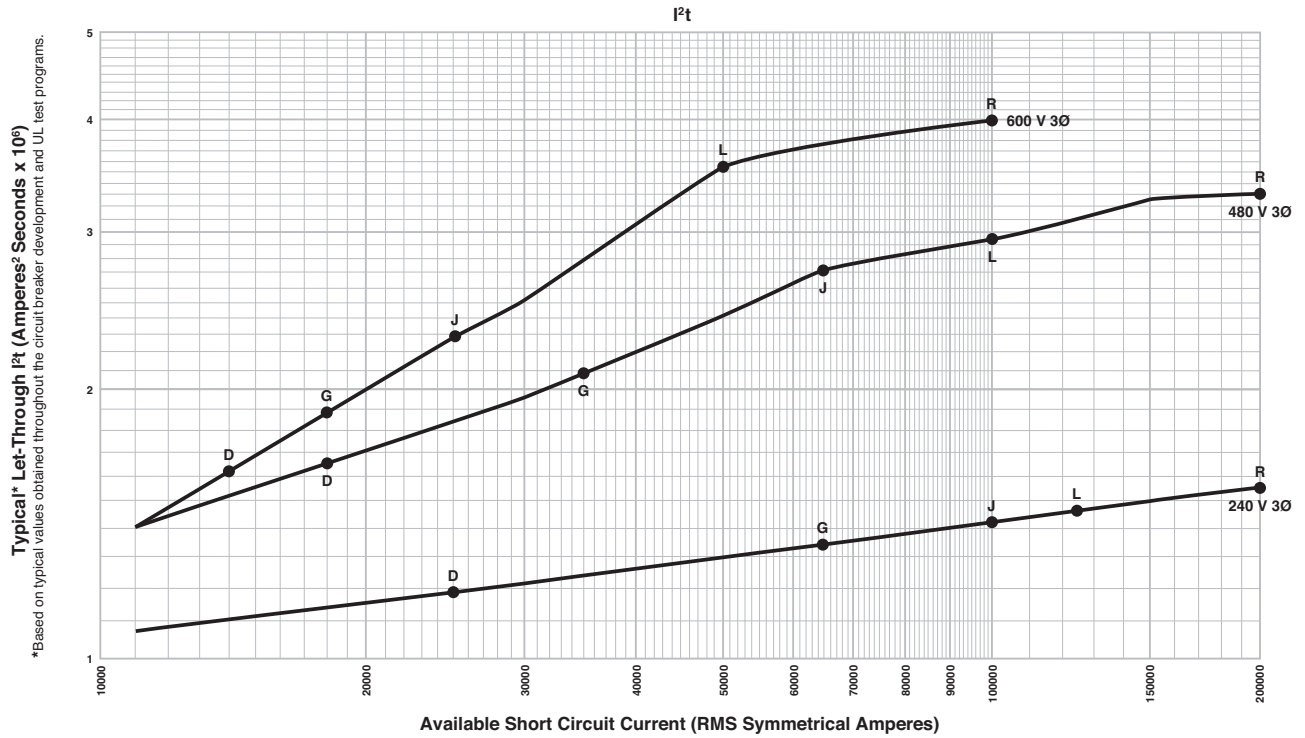

*Based on typical values obtained throughout the circuit breaker development and UL test programs.

PowerPact™ H-, J-, and L-Frame Circuit Breakers Trip Curves

Figure 111: L-Frame UL Listed Current-Limiting Circuit Breaker

ELECTRONIC MOLDED CASE CIRCUIT BREAKERS
POWERPACT™ L-FRAME CURRENT LIMITING CIRCUIT BREAKERS
 600 A FRAME AT 240, 480 AND 600 V, 3Ø
 LJ, LL AND LR 250–600 A
PEAK LET-THROUGH CURRENT I_p

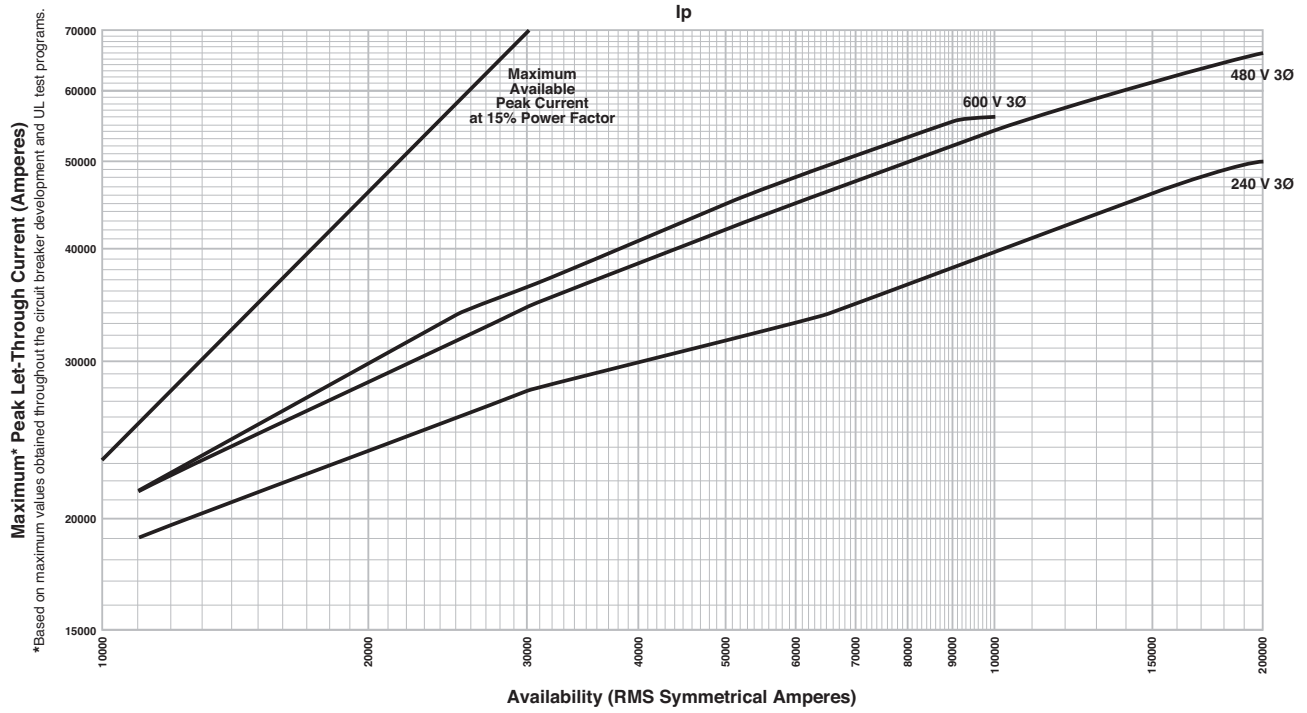

PowerPact™ H-, J-, and L-Frame Circuit Breakers Trip Curves

Figure 112: L-Frame UL Listed Current-Limiting Circuit Breaker

ELECTRONIC MOLDED CASE CIRCUIT BREAKERS
POWERPACT™ L-FRAME CURRENT LIMITING CIRCUIT BREAKERS
 600 A FRAME AT 240, 480 AND 600 V, 3Ø
 LJ, LL AND LR 250–600 A
 LET-THROUGH I^2t

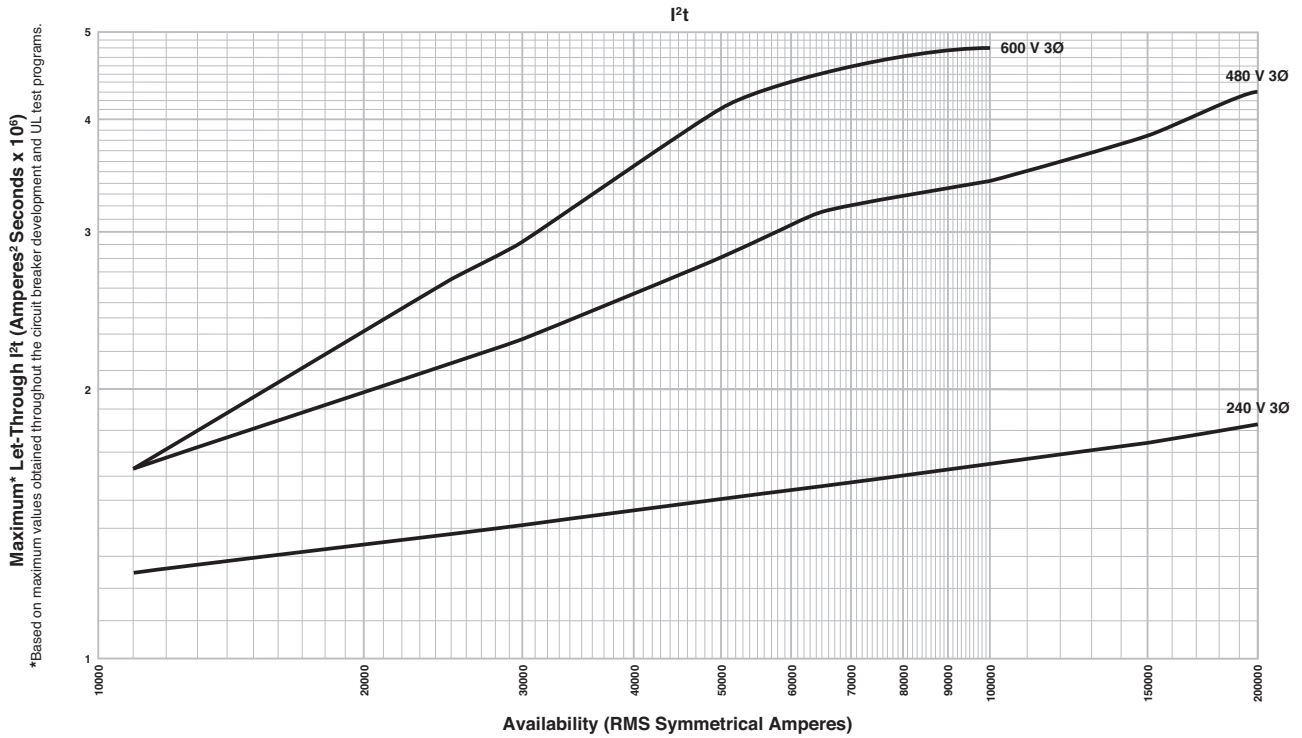
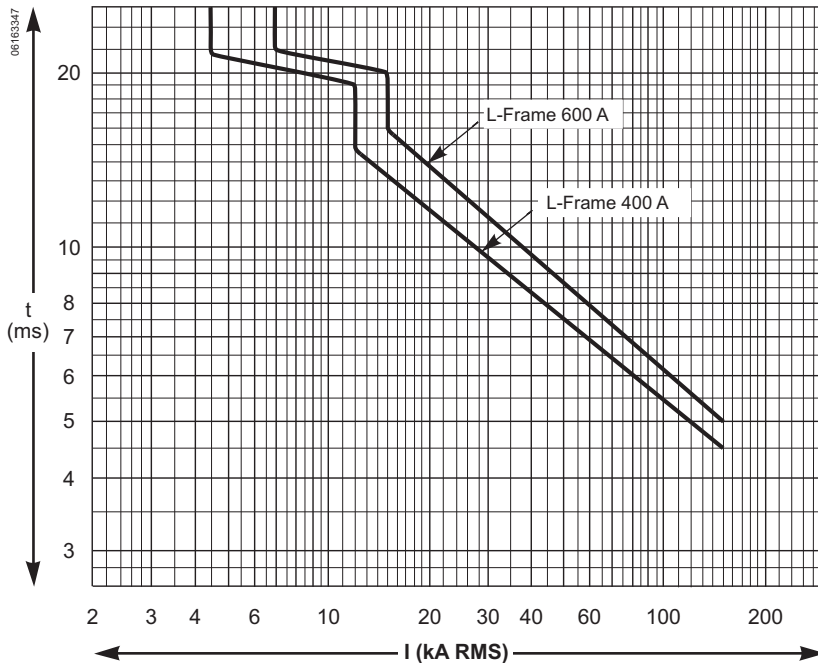

Figure 113: L-Frame Circuit Breaker Reflex Tripping



PowerPact™ H-, J-, and L-Frame Circuit Breakers
Catalog Numbers

Catalog Numbers

29271	122	HDA26110()	30	HDL26150C	26	HDL36150	26	HGA36050	30
29321	122	HDA26125()	30	HDL36015	26	HDL36150C	26	HGA36060	30
29348	124	HDA26150()	30	HDL36015C	26	HDL36150CU31X	28	HGA36060U31X	32
32521	122	HDA261501	119	HDL36015T	33	HDL36150CU33X	28	HGA36060U33X	32
32556	113	HDA261502	119	HDL36020	26	HDL36150CU43X	28	HGA36060U43X()	32
32595	114	HDA261503	119	HDL36020C	26	HDL36150CU53X	28	HGA36060U44X	32
685823	83	HDA261504	119	HDL36020T	33	HDL36150T	33	HGA36060U53X	32
685824	83	HDA261505	119	HDL36025	26	HDL36150TU31X	34	HGA36060U54X	32
685825	83	HDA261506	119	HDL36025C	26	HDL36150TU33X	34	HGA36070	30
685826	83	HDA36015	30	HDL36025T	33	HDL36150TU43X	34	HGA36080	30
685827	83	HDA36020	30	HDL36030	26	HDL36150TU44X	34	HGA36090	30
685829	83	HDA36025	30	HDL36030C	26	HDL36150TU53X	34	HGA36100	30
685831	84	HDA36030	30	HDL36030T	33	HDL36150TU54X	34	HGA36100U31X	32
9421LC46	108	HDA36035	30	HDL36035	26	HDL36150U31X	28	HGA36100U33X	32
9421LD1	108	HDA36040	30	HDL36035C	26	HDL36150U33X	28	HGA36100U43X	32
9421LD4	108	HDA36045	30	HDL36035T	33	HDL36150U43X	28	HGA36100U44X	32
9421LH46	108	HDA36050	30	HDL36040	26	HDL36150U44X	28	HGA36100U53X	32
9421LH6	108	HDA36060	30	HDL36040C	26	HDL36150U53X	28	HGA36100U54X	32
9421LJ1	107	HDA36060U31X	32	HDL36040T	33	HDL36150U54X	28	HGA36110	30
9421LJ4	107	HDA36060U33X	32	HDL36045	26	HE3060U31X	35	HGA36125	30
9421LJ7	108	HDA36060U43X	32	HDL36045C	26	HE3060U31X	68	HGA36150	30
9421LS13	108	HDA36060U44X	32	HDL36045T	33	HE3060U33X	35	HGA36150U31X	32
9421LS8	108	HDA36060U53X	32	HDL36050	26	HE3060U33X	68	HGA36150U33X	32
9422A1	108	HDA36060U54X	32	HDL36050C	26	HE3060U43X	35	HGA36150U43X	32
9422CSF10	108	HDA36070	30	HDL36050T	33	HE3060U43X	69	HGA36150U44X	32
9422CSF30	108	HDA36080	30	HDL36060	26	HE3060U43X	69	HGA36150U53X	32
9422CSF50	108	HDA36090	30	HDL36060C	26	HE3060U44X	35	HGA36150U54X	32
9422CSF70	108	HDA36100	30	HDL36060CU31X	28	HE3060U44X	69	HGF36000F06	35
9422CSJ10	108	HDA36100U31X	32	HDL36060CU33X	28	HE3060U53X	35	HGF36000F15	35
9422CSJ30	108	HDA36100U33X	32	HDL36060CU43X	28	HE3060U53X	69	HGL26015	26
9422CSJ50	108	HDA36100U43X	32	HDL36060CU53X	28	HE3060U54X	35	HGL26015C	26
9422RSI	108	HDA36100U44X	32	HDL36060T	33	HE3060U54X	69	HGL26020	26
9422RSI	109	HDA36100U53X	32	HDL36060TU31X	34	HE3100U31X	35	HGL26020C	26
AL150HD	124	HDA36100U54X	32	HDL36060TU33X	34	HE3100U31X	68	HGL26025	26
AL175JD	124	HDA36110	30	HDL36060TU43X	34	HE3100U33X	35	HGL26025C	26
AL250JD	124	HDA36125	30	HDL36060TU44X	34	HE3100U33X	68	HGL26030	26
AL400L61K3	124	HDA36150	119	HDL36060TU53X	34	HE3100U43X	35	HGL26030C	26
AL400L61K4	124	HDA36150	30	HDL36060TU54X	34	HE3100U44X	35	HGL26035	26
AL600LF52K3	124	HDA361506	119	HDL36060U31X	28	HE3100U44X	69	HGL26035C	26
AL600LS52K3	124	HDA36150U31X	32	HDL36060U33X	28	HE3100U53X	35	HGL26040	26
AL600LS52K4	124	HDA36150U33X	32	HDL36060U43X	28	HE3100U53X	69	HGL26040C	26
CU150HD	124	HDA36150U43X	32	HDL36060U44X	28	HE3100U54X	35	HGL26045	26
CU250JD	124	HDA36150U44X	32	HDL36060U53X	28	HE3100U54X	69	HGL26045C	26
CU400L61K3	124	HDA36150U53X	32	HDL36060U54X	28	HE3150U31X	35	HGL26050	26
CU400L61K4	124	HDA36150U54X	32	HDL36070	26	HE3150U31X	68	HGL26050C	26
CU600LF52K3	124	HDF36000F06	35	HDL36070C	26	HE3150U33X	35	HGL26060	26
CU600LS52K3	124	HDF36000F15	35	HDL36070T	33	HE3150U33X	68	HGL26060C	26
CU600LS52K4	124	HDL26015	26	HDL36080	26	HE3150U43X	35	HGL26070	26
CYA060HD	128	HDL26015C	26	HDL36080C	26	HE3150U43X	69	HGL26070C	26
CYA150HD	128	HDL26020	26	HDL36080T	33	HE3150U44X	35	HGL26080	26
CYA150JD	128	HDL26020C	26	HDL36090	26	HE3150U44X	69	HGL26080C	26
CYA250J3	128	HDL26025	26	HDL36090C	26	HE3150U53X	35	HGL26090	26
CYA400L31K3	128	HDL26025C	26	HDL36090T	33	HE3150U53X	69	HGL26090C	26
CYA400L31K4	128	HDL26030	26	HDL36100	26	HE3150U54X	35	HGL26100	26
CYA400L51K3	128	HDL26030C	26	HDL36100C	26	HE3150U54X	69	HGL26100C	26
CYA400L51K4	128	HDL26035	26	HDL36100CU31X	28	HGA26015()	30	HGL26110	26
CYA400L71K3	128	HDL26035C	26	HDL36100CU33X	28	HGA26020()	30	HGL26110C	26
CYA600L32K3	128	HDL26040	26	HDL36100CU43X	28	HGA26025()	30	HGL26125	26
CYA600L32K4	128	HDL26040C	26	HDL36100CU53X	28	HGA26030()	30	HGL26125C	26
CYA600L52K3	128	HDL26045	26	HDL36100T	33	HGA26035()	30	HGL26150	26
CYA600L52K4	128	HDL26045C	26	HDL36100TU31X	34	HGA26040()	30	HGL26150C	26
ELM150HD	105	HDL26050	26	HDL36100TU33X	34	HGA26045()	30	HGL36015	26
ELM250JD	105	HDL26050C	26	HDL36100TU43X	34	HGA26050()	30	HGL36015C	26
GFM150HD	104	HDL26060	26	HDL36100TU44X	34	HGA26060()	30	HGL36015T	33
GFM250JD	104	HDL26060C	26	HDL36100TU53X	34	HGA26070()	30	HGL36020	26
HDA26015()	30	HDL26070	26	HDL36100TU54X	34	HGA26080()	30	HGL36020C	26
HDA26020()	30	HDL26070C	26	HDL36100U31X	28	HGA26090()	30	HGL36020T	33
HDA26025()	30	HDL26080	26	HDL36100U33X	28	HGA26100()	30	HGL36025	26
HDA26030()	30	HDL26080C	26	HDL36100U43X	28	HGA26110()	30	HGL36025C	26
HDA26035()	30	HDL26090	26	HDL36100U44X	28	HGA26125()	30	HGL36025T	33
HDA26040()	30	HDL26090C	26	HDL36100U53X	28	HGA26150()	30	HGL36030	26
HDA26045()	30	HDL26100	26	HDL36100U54X	28	HGA36015	30	HGL36030C	26
HDA26050()	30	HDL26100C	26	HDL36110	26	HGA36020	30	HGL36030T	33
HDA26060()	30	HDL26110	26	HDL36110C	26	HGA36025	30	HGL36035	26
HDA26070()	30	HDL26110C	26	HDL36110T	33	HGA36030	30	HGL36035C	26
HDA26080()	30	HDL26125	26	HDL36125	26	HGA36035	30	HGL36035T	33
HDA26090()	30	HDL26125C	26	HDL36125C	26	HGA36040	30	HGL36040	26
HDA26100()	30	HDL26150	26	HDL36125T	33	HGA36045	30	HGL36040C	26

PowerPact™ H-, J-, and L-Frame Circuit Breakers

Catalog Numbers

HGL36040T	33	HJA26020()	30	HJL26125C	26	HJL36125	26	HLL26025C	26
HGL36045	26	HJA26025()	30	HJL26150	26	HJL36125C	26	HLL26030	26
HGL36045C	26	HJA26030()	30	HJL26150C	26	HJL36125T	33	HLL26030C	26
HGL36045T	33	HJA26035()	30	HJL36015	26	HJL36150	26	HLL26035	26
HGL36050	26	HJA26040()	30	HJL36015C	26	HJL36150C	26	HLL26035C	26
HGL36050C	26	HJA26045()	30	HJL36015T	33	HJL36150CU31X	28	HLL26040	26
HGL36050T	33	HJA26050()	30	HJL36020	26	HJL36150CU33X	28	HLL26040C	26
HGL36060	26	HJA26060()	30	HJL36020C	26	HJL36150CU43X	28	HLL26045	26
HGL36060C	26	HJA26070()	30	HJL36020T	33	HJL36150CU53X	28	HLL26045C	26
HGL36060CU31X	28	HJA26080()	30	HJL36025	26	HJL36150M74	50	HLL26050	26
HGL36060CU33X	28	HJA26090()	30	HJL36025C	26	HJL36150T	33	HLL26050C	26
HGL36060CU43X	28	HJA26100()	30	HJL36025T	33	HJL36150TU31X	34	HLL26060	26
HGL36060CU53X	28	HJA26110()	30	HJL36030	26	HJL36150TU33X	34	HLL26060C	26
HGL36060T	33	HJA26125()	30	HJL36030C	26	HJL36150TU43X	34	HLL26070	26
HGL36060TU31X	34	HJA26150()	30	HJL36030M71	50	HJL36150TU44X	34	HLL26070C	26
HGL36060TU33X	34	HJA36015	30	HJL36030T	33	HJL36150TU53X	34	HLL26080	26
HGL36060TU43X	34	HJA36020	30	HJL36035	26	HJL36150TU54X	34	HLL26080C	26
HGL36060TU44X	34	HJA36025	30	HJL36035C	26	HJL36150U31X	28	HLL26090	26
HGL36060TU53X	34	HJA36030	30	HJL36035T	33	HJL36150U33X	28	HLL26090C	26
HGL36060TU54X	34	HJA36035	30	HJL36040	26	HJL36150U43X	28	HLL26100	26
HGL36060U31X	28	HJA36040	30	HJL36040C	26	HJL36150U44X	28	HLL26100C	26
HGL36060U33X	28	HJA36045	30	HJL36040T	33	HJL36150U53X	28	HLL26110	26
HGL36060U43X	28	HJA36050	30	HJL36045	26	HJL36150U54X	28	HLL26110C	26
HGL36060U44X	28	HJA36060	30	HJL36045C	26	HLA26015()	30	HLL26125	26
HGL36060U53X	28	HJA36060U31X	32	HJL36045T	33	HLA26020()	30	HLL26125C	26
HGL36060U54X	28	HJA36060U33X	32	HJL36050	26	HLA26025()	30	HLL26150	26
HGL36070	26	HJA36060U43X	32	HJL36050C	26	HLA26030()	30	HLL26150C	26
HGL36070C	26	HJA36060U44X	32	HJL36050M72	50	HLA26035()	30	HLL36015	26
HGL36070T	33	HJA36060U53X	32	HJL36050T	33	HLA26040()	30	HLL36015C	26
HGL36080	26	HJA36060U54X	32	HJL36060	26	HLA26045()	30	HLL36015T	33
HGL36080C	26	HJA36070	30	HJL36060C	26	HLA26050()	30	HLL36020	26
HGL36080T	33	HJA36080	30	HJL36060CU31X	28	HLA26060()	30	HLL36020C	26
HGL36090	26	HJA36090	30	HJL36060CU33X	28	HLA26070()	30	HLL36020T	33
HGL36090C	26	HJA36100	30	HJL36060CU43X	28	HLA26080()	30	HLL36025	26
HGL36090T	33	HJA36100U31X	32	HJL36060CU53X	28	HLA26090()	30	HLL36025C	26
HGL36100	26	HJA36100U33X	32	HJL36060T	33	HLA26100()	30	HLL36025T	33
HGL36100C	26	HJA36100U43X	32	HJL36060TU31X	34	HLA26110()	30	HLL36030	26
HGL36100CU31X	28	HJA36100U44X	32	HJL36060TU33X	34	HLA26125()	30	HLL36030C	26
HGL36100CU33X	28	HJA36100U53X	32	HJL36060TU43X	34	HLA26150()	30	HLL36030M71	50
HGL36100CU43X	28	HJA36100U54X	32	HJL36060TU44X	34	HLA36015	30	HLL36030T	33
HGL36100CU53X	28	HJA36110	30	HJL36060TU53X	34	HLA36020	30	HLL36035	26
HGL36100T	33	HJA36125	30	HJL36060TU54X	34	HLA36025	30	HLL36035C	26
HGL36100TU31X	34	HJA36150	30	HJL36060U31X	28	HLA36030	30	HLL36035T	33
HGL36100TU33X	34	HJA36150U31X	32	HJL36060U33X	28	HLA36035	30	HLL36040	26
HGL36100TU43X	34	HJA36150U33X	32	HJL36060U43X	28	HLA36040	30	HLL36040C	26
HGL36100TU44X	34	HJA36150U43X	32	HJL36060U44X	28	HLA36045	30	HLL36040T	33
HGL36100TU53X	34	HJA36150U44X	32	HJL36060U53X	28	HLA36050	30	HLL36045	26
HGL36100TU54X	34	HJA36150U53X	32	HJL36060U54X	28	HLA36060	30	HLL36045C	26
HGL36100U31X	28	HJA36150U54X()	32	HJL36070	26	HLA36060U31X	32	HLL36045T	33
HGL36100U33X	28	HJF36000F06	35	HJL36070C	26	HLA36060U33X	32	HLL36050	26
HGL36100U43X	28	HJF36000F15	35	HJL36070T	33	HLA36060U43X	32	HLL36050C	26
HGL36100U44X	28	HJL26015	26	HJL36080	26	HLA36060U44X	32	HLL36050M72	50
HGL36100U53X	28	HJL26015C	26	HJL36080C	26	HLA36060U53X	32	HLL36050T	33
HGL36100U54X	28	HJL26020	26	HJL36080C	26	HLA36060U54X	32	HLL36060	26
HGL36110	26	HJL26020C	26	HJL36080T	33	HLA36060U54X	32	HLL36060C	26
HGL36110C	26	HJL26025	26	HJL36090	26	HLA36070	30	HLL36060CU31X	28
HGL36110T	33	HJL26025C	26	HJL36090C	26	HLA36080	30	HLL36060CU33X	28
HGL36125	26	HJL26030	26	HJL36090T	33	HLA36090	30	HLL36060CU43X	28
HGL36125C	26	HJL26030C	26	HJL36100	26	HLA36100	30	HLL36060CU53X	28
HGL36125T	33	HJL26035	26	HJL36100C	26	HLA36100U31X	32	HLL36060T	33
HGL36150	26	HJL26035C	26	HJL36100CU31X	28	HLA36100U33X	32	HLL36060TU31X	34
HGL36150C	26	HJL26040	26	HJL36100CU33X	28	HLA36100U43X	32	HLL36060TU33X	34
HGL36150CU31X	28	HJL26040C	26	HJL36100CU43X	28	HLA36100U44X	32	HLL36060TU43X	34
HGL36150CU33X	28	HJL26045	26	HJL36100CU53X	28	HLA36100U53X	32	HLL36060TU44X	34
HGL36150CU43X	28	HJL26045C	26	HJL36100M73	50	HLA36100U54X	32	HLL36060TU53X	34
HGL36150CU53X	28	HJL26050	26	HJL36100T	33	HLA36110	30	HLL36060TU54X	34
HGL36150T	33	HJL26050C	26	HJL36100TU31X	34	HLA36125	30	HLL36060U31X	28
HGL36150TU31X	34	HJL26060	26	HJL36100TU33X	34	HLA36150	30	HLL36060U33X	28
HGL36150TU33X	34	HJL26060C	26	HJL36100TU43X	34	HLA36150U31	32	HLL36060U43X	28
HGL36150TU43X	34	HJL26060C	26	HJL36100TU44X	34	HLA36150U33X	32	HLL36060U44X	28
HGL36150TU44X	34	HJL26070	26	HJL36100TU53X	34	HLA36150U43X	32	HLL36060U53X	28
HGL36150TU53X	34	HJL26070C	26	HJL36100TU54X	34	HLA36150U44X	32	HLL36060U54X	28
HGL36150TU54X	34	HJL26080	26	HJL36100U31X	28	HLA36150U53X	32	HLL36070	26
HGL36150U31X	28	HJL26080C	26	HJL36100U33X	28	HLA36150U54X	32	HLL36070C	26
HGL36150U33X	28	HJL26090	26	HJL36100U43X	28	HLF36000F06	35	HLL36070T	33
HGL36150U43X	28	HJL26090C	26	HJL36100U44X	28	HLF36000F15	35	HLL36080	26
HGL36150U44X	28	HJL26100	26	HJL36100U53X	28	HLL26015	26	HLL26015	26
HGL36150U53X	28	HJL26100C	26	HJL36100U54X	28	HLL26015C	26	HLL26015C	26
HGL36150U54X	28	HJL26110	26	HJL36110C	26	HLL26020	26	HLL26020	26
HJA26015()	30	HJL26110C	26	HJL36110C	26	HLL26020C	26	HLL26020C	26
		HJL26125	26	HJL36110T	33	HLL26025	26	HLL26025	26

PowerPact™ H-, J-, and L-Frame Circuit Breakers

Catalog Numbers

HLL36090T	33	HRL36100CU53X	28	JDL26225	27	JGL26200	27	JLL26225C	27
HLL36100	26	HRL36100M73	50	JDL26225C	27	JGL26200C	27	JLL26250	27
HLL36100C	26	HRL36100U31X	28	JDL26250	27	JGL26225	27	JLL26250C	27
HLL36100CU31X	28	HRL36100U33X	28	JDL26250C	27	JGL26225C	27	JLL34250WU31X	29
HLL36100CU33X	28	HRL36100U43X	28	JDL34250WU31X	29	JGL26250	27	JLL34250WU33X	29
HLL36100CU43X	28	HRL36100U44X	28	JDL34250WU33X	29	JGL26250C	27	JLL34250WU43X	29
HLL36100CU53X	28	HRL36100U53X	28	JDL34250WU43X	29	JGL34250WU31X	29	JLL34250WU44X	29
HLL36100M73	50	HRL36100U54X	28	JDL34250WU44X	29	JGL34250WU33X	29	JLL34250WU53X	29
HLL36100T	33	HRL36150CU31X	28	JDL34250WU53X	29	JGL34250WU43X	29	JLL34250WU54X	29
HLL36100TU31X	34	HRL36150CU33X	28	JDL34250WU54X	29	JGL34250WU44X	29	JLL36150	27
HLL36100TU33X	34	HRL36150CU43X	28	JDL36150	27	JGL34250WU53X	29	JLL36150C	27
HLL36100TU43X	34	HRL36150CU53X	28	JDL36150C	27	JGL34250WU54X	29	JLL36150T	33
HLL36100TU44X	34	HRL36150M74	50	JDL36150T	33	JGL36150	27	JLL36175	27
HLL36100TU53X	34	HRL36150U31X	28	JDL36175	27	JGL36150C	27	JLL36175C	27
HLL36100TU54X	34	HRL36150U33X	28	JDL36175C	27	JGL36150T	33	JLL36175T	33
HLL36100U31X	28	HRL36150U43X	28	JDL36175T	33	JGL36175	27	JLL36200	27
HLL36100U33X	28	HRL36150U44X	28	JDL36200	27	JGL36175C	27	JLL36200C	27
HLL36100U43X	28	HRL36150U53X	28	JDL36200C	27	JGL36175T	33	JLL36200T	33
HLL36100U44X	28	HRL36150U54X	28	JDL36200T	33	JGL36200	27	JLL36225	27
HLL36100U53X	28	HT3015	34	JDL36225	27	JGL36200C	27	JLL36225C	27
HLL36100U54X	28	HT3015	61	JDL36225C	27	JGL36200T	33	JLL36225T	33
HLL36110	26	HT3020	34	JDL36225T	33	JGL36225	27	JLL36250	27
HLL36110C	26	HT3020	61	JDL36250	27	JGL36225C	27	JLL36250C	27
HLL36110T	33	HT3025	34	JDL36250C	27	JGL36225T	33	JLL36250CU31X	28
HLL36125	26	HT3025	61	JDL36250CU31X	28	JGL36250	27	JLL36250CU33X	28
HLL36125C	26	HT3030	34	JDL36250CU33X	28	JGL36250C	27	JLL36250CU43X	28
HLL36125T	33	HT3030	61	JDL36250CU43X	28	JGL36250CU31X	28	JLL36250CU53X	28
HLL36150	26	HT3035	34	JDL36250CU53X	28	JGL36250CU33X	28	JLL36250M75	50
HLL36150C	26	HT3035	61	JDL36250T	33	JGL36250CU43X	28	JLL36250T	33
HLL36150CU31X	28	HT3040	34	JDL36250TU31X	34	JGL36250CU53X	28	JLL36250TU31X	34
HLL36150CU33X	28	HT3040	61	JDL36250TU33X	34	JGL36250T	33	JLL36250TU33X	34
HLL36150CU43X	28	HT3045	34	JDL36250TU43X	34	JGL36250TU31X	34	JLL36250TU43X	34
HLL36150CU53X	28	HT3045	61	JDL36250TU44X	34	JGL36250TU33X	34	JLL36250TU44X	34
HLL36150M74	50	HT3050	34	JDL36250TU53X	34	JGL36250TU43X	34	JLL36250TU54X	34
HLL36150T	33	HT3050	61	JDL36250TU54X	34	JGL36250TU44X	34	JLL36250U31X	28
HLL36150TU31X	34	HT3060	34	JDL36250U31X	28	JGL36250TU53X	34	JLL36250U33X	28
HLL36150TU33X	34	HT3060	61	JDL36250U33X	28	JGL36250TU54X	34	JLL36250U43X	28
HLL36150TU43X	34	HT3070	34	JDL36250U43X	28	JGL36250U31X	28	JLL36250U44X	28
HLL36150TU44X	34	HT3070	61	JDL36250U44X	28	JGL36250U33X	28	JLL36250U53X	28
HLL36150TU53X	34	HT3080	34	JDL36250U53X	28	JGL36250U43X	28	JLL36250U54X	28
HLL36150TU54X	34	HT3080	61	JDL36250U54X	28	JGL36250U44X	28	JLL36250U54X	28
HLL36150U31X	28	HT3090	34	JE3250U31X	35	JGL36250U53X	28	JLA34250WU31X	32
HLL36150U33X	28	HT3090	61	JE3250U31X	68	JGL36250U54X	28	JLA34250WU33X	32
HLL36150U43X	28	HT3100	34	JE3250U33X	35	JGL37100D81	18	JLA34250WU43X	32
HLL36150U44X	28	HT3100	61	JE3250U33X	68	JGL37125D81	18	JLA34250WU44X	32
HLL36150U53X	28	HT3110	34	JE3250U43X	35	JGL37150D81	18	JLA34250WU53X	32
HLL36150U54X	28	HT3110	61	JE3250U43X	69	JGL37175D81	18	JLA34250WU54X	32
HRA36060U31X	32	HT3125	34	JE3250U44X	35	JGL37200D82	18	JLA36150	31
HRA36060U33X	32	HT3125	61	JE3250U44X	69	JGL37225D82	18	JLA36175	31
HRA36060U43X	32	HT3150	34	JE3250U53X	35	JGL37250D82	18	JLA36200	31
HRA36060U44X	32	HT3150	61	JE3250U53X	69	JJA26150()	31	JLA36225	31
HRA36060U53X	32	JDA26150()	31	JE3250U54X	35	JJA26175()	31	JLA36250	31
HRA36060U54X	32	JDA26175()	31	JE3250U54X	69	JJA26200()	31	JLA36250U31X	32
HRA36100U31X	32	JDA26200()	31	JGA26150()	31	JJA26225()	31	JLA36250U33X	32
HRA36100U33X	32	JDA26225()	31	JGA26175()	31	JJA26250()	31	JLA36250U43X	32
HRA36100U43X	32	JDA26250()	31	JGA26200()	31	JJA34250WU31X	32	JLA36250U44X	32
HRA36100U44X	32	JDA34250WU31X	32	JGA26225()	31	JJA34250WU33X	32	JLA36250U53X	32
HRA36100U53X	32	JDA34250WU33X	32	JGA26250()	31	JJA34250WU43X	32	JLA36250U54X	32
HRA36100U54X	32	JDA34250WU43X	32	JGA34250WU31X	32	JJA34250WU44X	32	JLF36000F25	35
HRA36150U31	32	JDA34250WU44X	32	JGA34250WU33X	32	JJA34250WU53X	32	JLL26150	27
HRA36150U33X	32	JDA34250WU53X	32	JGA34250WU43X	32	JJA34250WU54X	32	JLL26150C	27
HRA36150U43X	32	JDA34250WU54X	32	JGA34250WU44X	32	JJA36150	31	JLL26175	27
HRA36150U44X	32	JDA36150	31	JGA34250WU53X	32	JJA36175	31	JLL26175C	27
HRA36150U53X	32	JDA36175	31	JGA34250WU54X	32	JJA36200	31	JLL26200	27
HRA36150U54X	32	JDA36200	31	JGA36150	31	JJA36225	31	JLL26200C	27
HRL36030M71	50	JDA36225	31	JGA36175	31	JJA36250	31	JLL26225	27
HRL36050M72	50	JDA36250	31	JGA36200	31	JJA36250U31X	32	JLL26225C	27
HRL36060CU31X	28	JDA36250U31X	32	JGA36225	31	JJA36250U33X	32	JLL26250	27
HRL36060CU33X	28	JDA36250U33X	32	JGA36250	31	JJA36250U43X	32	JLL26250C	27
HRL36060CU43X	28	JDA36250U43X	32	JGA36250U31X	32	JJA36250U44X	32	JLL26250C	27
HRL36060CU53X	28	JDA36250U44X	32	JGA36250U33X	32	JJA36250U53X	32	JLL34250WU31X	29
HRL36060U31X	28	JDA36250U53X	32	JGA36250U43X	32	JJA36250U54X	32	JLL34250WU33X	29
HRL36060U33X	28	JDA36250U54X	32	JGA36250U44X	32	JJF36000F25	35	JLL34250WU43X	29
HRL36060U43X	28	JDF36000F25	35	JGA36250U53X	32	JLL26150	27	JLL34250WU44X	29
HRL36060U44X	28	JDL26150	27	JGA36250U54X	32	JLL26150C	27	JLL34250WU53X	29
HRL36060U53X	28	JDL26150C	27	JGF36000F25	35	JLL26175	27	JLL34250WU54X	29
HRL36060U54X	28	JDL26175	27	JGL26150	27	JLL26175C	27	JLL36150	27
HRL36100CU31X	28	JDL26175C	27	JGL26150C	27	JLL26200	27	JLL36150C	27
HRL36100CU33X	28	JDL26200	27	JGL26175	27	JLL26200C	27	JLL36150T	33
HRL36100CU43X	28	JDL26200C	27	JGL26175C	27	JLL26225	27	JLL36175	27
								JLL36175C	27

PowerPact™ H-, J-, and L-Frame Circuit Breakers

Catalog Numbers

JLL36175T 33	LDA34600WU44X 39	LDL36600U31X 36	LE4600U43X 69	LGL36400RU54X 40
JLL36200 27	LDA34600WU53X 39	LDL36600U33X 36	LE4600U44X 69	LGL36400TU31X 40
JLL36200C 27	LDA34600WU54X 39	LDL36600U43X 36	LE4600U53X 69	LGL36400TU33X 40
JLL36200T 33	LDA36250CU31X 40	LDL36600U44X 36	LE4600U54X 69	LGL36400TU43X 40
JLL36225 27	LDA36250CU33X 40	LDL36600U53X 36	LGA34250WU31X 39	LGL36400TU44X 40
JLL36225C 27	LDA36250U31X 39	LDL36600U54X 36	LGA34250WU33X 39	LGL36400TU53X 40
JLL36225T 33	LDA36250U33X 39	LDL44250WU31X 38	LGA34400WU31X 39	LGL36400TU54X 40
JLL36250 27	LDA36400CU31X 40	LDL44250WU33X 38	LGA34400WU33X 39	LGL36400U31X 36
JLL36250C 27	LDA36400CU33X 40	LDL44400WU31X 38	LGA34400WU43X 39	LGL36400U33X 36
JLL36250CU31X 28	LDA36400CU43X 40	LDL44400WU33X 38	LGA34400WU44X 39	LGL36400U43X 36
JLL36250CU33X 28	LDA36400CU44X 40	LDL44400WU43X 38	LGA34400WU53X 39	LGL36400U44X 36
JLL36250CU43X 28	LDA36400CU53X 40	LDL44400WU44X 38	LGA34400WU54X 39	LGL36400U53X 36
JLL36250CU54X 28	LDA36400CU54X 40	LDL44400WU53X 38	LGA34600WU31X 39	LGL36400U54X 36
JLL36250M75 50	LDA36400U31X 39	LDL44400WU54X 38	LGA34600WU33X 39	LGL36600TU31X 40
JLL36250T 33	LDA36600U31X 39	LDL44600WU31X 38	LGA34600WU43X 39	LGL36600TU33X 40
JLL36250TU31X 34	LDA36400U33X 39	LDL44600WU33X 38	LGA34600WU44X 39	LGL36600TU43X 40
JLL36250TU33X 34	LDA36400U43X 39	LDL44600WU43X 38	LGA34600WU53X 39	LGL36600TU44X 40
JLL36250TU43X 34	LDA36400U44X 39	LDL44600WU44X 38	LGA34600WU54X 39	LGL36600TU53X 40
JLL36250TU44X 34	LDA36400U53X 39	LDL44600WU53X 38	LGA36000S40X 45	LGL36600TU54X 40
JLL36250TU53X 34	LDA36400U54X 39	LDL44600WU54X 38	LGA36000S60X 45	LGL36600U31X 36
JLL36250TU54X 34	LDA36600U33X 39	LDL46250CU31X 38	LGA36250CU31X 40	LGL36600U33X 36
JLL36250U31X 28	LDA36600U43X 39	LDL46250CU33X 38	LGA36250CU33X 40	LGL36600U43X 36
JLL36250U33X 28	LDA36600U44X 39	LDL46250U31X 38	LGA36250U31X 39	LGL36600U44X 36
JLL36250U43X 28	LDA36600U53X 39	LDL46250U33X 38	LGA36250U33X 39	LGL36600U53X 36
JLL36250U44X 28	LDA36600U54X 39	LDL46400CU31X 38	LGA36400CU31X 40	LGL36600U54X 36
JLL36250U53X 28	LDF36000F25 41	LDL46400CU33X 38	LGA36400CU33X 40	LGL44250WU31X 38
JLL36250U54X 28	LDF36000F40 41	LDL46400CU43X 38	LGA36400CU43X 40	LGL44250WU33X 38
JRA36150 31	LDF36000F60 41	LDL46400CU44X 38	LGA36400CU44X 40	LGL44400WU31X 38
JRA36175 31	LDL34250WU31X 37	LDL46400CU53X 38	LGA36400CU53X 40	LGL44400WU33X 38
JRA36200 31	LDL34250WU33X 37	LDL46400CU54X 38	LGA36400CU54X 40	LGL44400WU43X 38
JRA36225 31	LDL34400WU31X 37	LDL46400U31X 38	LGA36400U31X 39	LGL44400WU44X 38
JRA36250 31	LDL34400WU33X 37	LDL46400U33X 38	LGA36400U33X 39	LGL44400WU53X 38
JRA36250U31X 32	LDL34400WU43X 37	LDL46400U43X 38	LGA36400U43X 39	LGL44400WU54X 38
JRA36250U33X 32	LDL34400WU44X 37	LDL46400U44X 38	LGA36400U44X 39	LGL44600WU31X 38
JRA36250U43X 32	LDL34400WU53X 37	LDL46400U53X 38	LGA36400U53X 39	LGL44600WU33X 38
JRA36250U44X 32	LDL34400WU54X 37	LDL46400U54X 38	LGA36400U54X 39	LGL44600WU43X 38
JRA36250U53X 32	LDL34600WU31X 37	LDL46600U31X 38	LGA36600U31X 39	LGL44600WU44X 38
JRA36250U54X 32	LDL34600WU33X 37	LDL46600U33X 38	LGA36600U33X 39	LGL44600WU53X 38
JRL36150 27	LDL34600WU43X 37	LDL46600U43X 38	LGA36600U43X 39	LGL44600WU54X 38
JRL36150C 27	LDL34600WU44X 37	LDL46600U44X 38	LGA36600U44X 39	LGL46000S40X 45
JRL36175 27	LDL34600WU53X 37	LDL46600U53X 38	LGA36600U53X 39	LGL46000S60X 45
JRL36175C 27	LDL34600WU54X 37	LDL46600U54X 38	LGA36600U54X 39	LGL46250CU31X 38
JRL36200 27	LDL36250CU31X 36	LE3250U31X 41	LGF36000F25 41	LGL46250CU33X 38
JRL36200C 27	LDL36250CU33X 36	LE3250U31X 68	LGF36000F40 41	LGL46250U31X 38
JRL36225 27	LDL36250RU31X 40	LE3250U33X 41	LGF36000F60 41	LGL46250U33X 38
JRL36225C 27	LDL36250RU33X 40	LE3250U33X 68	LGL34250WU31X 37	LGL46400CU31X 38
JRL36250 27	LDL36250TU31X 40	LE3400U31X 41	LGL34250WU33X 37	LGL46400CU33X 38
JRL36250C 27	LDL36250TU33X 40	LE3400U31X 68	LGL34400WU31X 37	LGL46400CU43X 38
JRL36250CU31X 28	LDL36250U31X 36	LE3400U33X 41	LGL34400WU33X 37	LGL46400CU44X 38
JRL36250CU33X 28	LDL36250U33X 36	LE3400U33X 68	LGL34400WU43X 37	LGL46400CU53X 38
JRL36250CU43X 28	LDL36400CU31X 36	LE3400U43X 41	LGL34400WU44X 37	LGL46400CU54X 38
JRL36250CU53X 28	LDL36400CU33X 36	LE3400U43X 69	LGL34400WU53X 37	LGL46400U31X 38
JRL36250M75 50	LDL36400CU43X 36	LE3400U44X 41	LGL34400WU54X 37	LGL46400U33X 38
JRL36250U31X 28	LDL36400CU44X 36	LE3400U44X 69	LGL34600WU31X 37	LGL46400U43X 38
JRL36250U33X 28	LDL36400CU53X 36	LE3400U53X 41	LGL34600WU33X 37	LGL46400U44X 38
JRL36250U43X 28	LDL36400CU54X 36	LE3400U53X 69	LGL34600WU43X 37	LGL46400U53X 38
JRL36250U44X 28	LDL36400RU31X 40	LE3400U54X 41	LGL34600WU44X 37	LGL46400U54X 38
JRL36250U53X 28	LDL36400RU33X 40	LE3400U54X 69	LGL34600WU53X 37	LGL46600U31X 38
JRL36250U54X 28	LDL36400RU43X 40	LE3600U31X 41	LGL34600WU54X 37	LGL46600U33X 38
JT3150 34	LDL36400RU44X 40	LE3600U31X 68	LGL36000S40X 45	LGL46600U43X 38
JT3150 61	LDL36400RU53X 40	LE3600U33X 41	LGL36000S60X 45	LGL46600U44X 38
JT3175 34	LDL36400RU54X 40	LE3600U33X 68	LGL36250CU31X 36	LGL46600U53X 38
JT3175 61	LDL36400TU31X 40	LE3600U43X 41	LGL36250CU33X 36	LGL46600U54X 38
JT3200 34	LDL36400TU33X 40	LE3600U43X 69	LGL36250RU31X 40	LJA34250WU31X 39
JT3200 61	LDL36400TU43X 40	LE3600U44X 41	LGL36250RU33X 40	LJA34250WU33X 39
JT3225 34	LDL36400TU44X 40	LE3600U44X 69	LGL36250TU31X 40	LJA34400WU31X 39
JT3225 61	LDL36400TU53X 40	LE3600U53X 41	LGL36250TU33X 40	LJA34400WU33X 39
JT3250 34	LDL36400TU54X 40	LE3600U53X 69	LGL36250U31X 36	LJA34400WU43X 39
JT3250 61	LDL36400U31X 36	LE3600U54X 41	LGL36250U33X 36	LJA34400WU44X 39
LDA34250WU31X 39	LDL36400U33X 36	LE3600U54X 69	LGL36400CU31X 36	LJA34400WU53X 39
LDA34250WU33X 39	LDL36400U43X 36	LE4250U31X 68	LGL36400CU33X 36	LJA34400WU54X 39
LDA34400WU31X 39	LDL36400U44X 36	LE4250U33X 68	LGL36400CU43X 36	LJA34600WU31X 39
LDA34600WU31X 39	LDL36400U53X 36	LE4400U31X 68	LGL36400CU44X 36	LJA34600WU33X 39
LDA34400WU33X 39	LDL36400U54X 36	LE4400U33X 68	LGL36400CU53X 36	LJA34600WU43X 39
LDA34400WU43X 39	LDL36600TU31X 40	LE4400U43X 69	LGL36400CU54X 36	LJA34600WU44X 39
LDA34400WU44X 39	LDL36600TU33X 40	LE4400U44X 69	LGL36400RU31X 40	LJA34600WU53X 39
LDA34400WU53X 39	LDL36600TU43X 40	LE4400U53X 69	LGL36400RU33X 40	LJA34600WU54X 39
LDA34400WU54X 39	LDL36600TU44X 40	LE4400U54X 69	LGL36400RU43X 40	LJA36250CU31X 40
LDA34600WU33X 39	LDL36600TU53X 40	LE4600U31X 68	LGL36400RU44X 40	LJA36250CU33X 40
LDA34600WU43X 39	LDL36600TU54X 40	LE4600U33X 68	LGL36400RU53X 40	LJA36250U31X 39

PowerPact™ H-, J-, and L-Frame Circuit Breakers

Catalog Numbers

LJA36250U33X	39	LJL44250WU31X	38	LLL34400WU33X	37	LLL46400CU44X	38	LRL46400U54X	38
LJA36400CU31X	40	LJL44250WU33X	38	LLL34400WU43X	37	LLL46400CU53X	38	LRL46600U31X	38
LJA36400CU33X	40	LJL44400WU31X	38	LLL34400WU44X	37	LLL46400CU54X	38	LRL46600U33X	38
LJA36400CU43X	40	LJL44400WU33X	38	LLL34400WU53X	37	LLL46400U31X	38	LRL46600U43X	38
LJA36400CU44X	40	LJL44400WU43X	38	LLL34400WU54X	37	LLL46400U33X	38	LRL46600U44X	38
LJA36400CU53X	40	LJL44400WU44X	38	LLL34600WU31X	37	LLL46400U43X	38	LRL46600U53X	38
LJA36400CU54X	40	LJL44400WU53X	38	LLL34600WU33X	37	LLL46400U44X	38	LRL46600U54X	38
LJA36400U31X	39	LJL44400WU54X	38	LLL34600WU43X	37	LLL46400U53X	38	MICROTUSEAL	113
LJA36400U33X	39	LJL44600WU31X	38	LLL34600WU44X	37	LLL46400U54X	38	MICROTUSEAL	69
LJA36400U43X	39	LJL44600WU33X	38	LLL34600WU53X	37	LLL46600U31X	38	PDC12DG4L3	126
LJA36400U44X	39	LJL44600WU43X	38	LLL34600WU54X	37	LLL46600U33X	38	PDC3HD2	126
LJA36400U53X	39	LJL44600WU44X	38	LLL36000S40X	45	LLL46600U43X	38	PDC3JD20	126
LJA36400U54X	39	LJL44600WU53X	38	LLL36000S60X	45	LLL46600U44X	38	PDC5DG20L3	126
LJA36600U31X	39	LJL44600WU54X	38	LLL36250CU31X	36	LLL46600U53X	38	PDC6HD6	126
LJA36600U33X	39	LJL46250CU31X	38	LLL36250CU33X	36	LLL46600U54X	38	PDC6JD4	126
LJA36600U43X	39	LJL46250CU33X	38	LLL36250RU31X	40	LRA36000S40X	45	S29272	122
LJA36600U44X	39	LJL46250U31X	38	LLL36250RU33X	40	LRA36000S60X	45	S29273	122
LJA36600U53X	39	LJL46250U33X	38	LLL36250TU31X	40	LRA36250CU31X	40	S29273	122
LJA36600U54X	39	LJL46400CU31X	38	LLL36250TU33X	40	LRA36250CU33X	40	S29273	122
LJF36000F25	41	LJL46400CU33X	38	LLL36250U31X	36	LRA36250U31X	39	S29274	122
LJF36000F40	41	LJL46400CU43X	38	LLL36250U33X	36	LRA36250U33X	39	S29274	122
LJF36000F60	41	LJL46400CU44X	38	LLL36400CU31X	36	LRA36400CU31X	40	S29275	122
LJL34250WU31X	37	LJL46400CU53X	38	LLL36400CU33X	36	LRA36400CU33X	40	S29275	122
LJL34250WU33X	37	LJL46400CU54X	38	LLL36400CU43X	36	LRA36400CU43X	40	S29278	122
LJL34400WU31X	37	LJL46400U31X	38	LLL36400CU44X	36	LRA36400CU44X	40	S29278	122
LJL34400WU33X	37	LJL46400U33X	38	LLL36400CU53X	36	LRA36400CU53X	40	S29282	122
LJL34400WU43X	37	LJL46400U43X	38	LLL36400CU54X	36	LRA36400CU54X	40	S29283	122
LJL34400WU44X	37	LJL46400U44X	38	LLL36400RU31X	40	LRA36400U31X	39	S29284	114
LJL34400WU53X	37	LJL46400U53X	38	LLL36400RU33X	40	LRA36400U33X	39	S29284	122
LJL34400WU54X	37	LJL46400U54X	38	LLL36400RU43X	40	LRA36400U43X	39	S29284	122
LJL34600WU31X	37	LJL46600U31X	38	LLL36400RU44X	40	LRA36400U44X	39	S29286	122
LJL34600WU33X	37	LJL46600U33X	38	LLL36400RU53X	40	LRA36400U53X	39	S29286	122
LJL34600WU43X	37	LJL46600U43X	38	LLL36400RU54X	40	LRA36400U54X	39	S29287	122
LJL34600WU44X	37	LJL46600U44X	38	LLL36400TU31X	40	LRA36600U31X	39	S29287	122
LJL34600WU53X	37	LJL46600U53X	38	LLL36400TU33X	40	LRA36600U33X	39	S29287	122
LJL34600WU54X	37	LJL46600U54X	38	LLL36400TU43X	40	LRA36600U43X	39	S29313	114
LJL36250CU31X	36	LLA34250WU31X	39	LLL36400TU44X	40	LRA36600U44X	39	S29315	113
LJL36250CU33X	36	LLA34250WU33X	39	LLL36400TU53X	40	LRA36600U53X	39	S29317	113
LJL36250RU31X	40	LLA34400WU31X	39	LLL36400TU54X	40	LRA36600U54X	39	S29319	114
LJL36250RU33X	40	LLA34400WU33X	39	LLL36400U31X	36	LRL36000S40X	45	S29375	113
LJL36250TU31X	40	LLA34400WU43X	39	LLL36400U33X	36	LRL36000S60X	45	S29382	101
LJL36250TU33X	40	LLA34400WU44X	39	LLL36400U43X	36	LRL36250CU31X	36	S29383	101
LJL36250U31X	36	LLA34400WU53X	39	LLL36400U44X	36	LRL36250CU33X	36	S29384	101
LJL36250U33X	36	LLA34400WU54X	39	LLL36400U53X	36	LRL36250U31X	36	S29385	101
LJL36400CU31X	36	LLA34600WU31X	39	LLL36400U54X	36	LRL36250U33X	36	S29386	101
LJL36400CU43X	36	LLA34600WU33X	39	LLL36600TU31X	40	LRL36400CU31X	36	S29387	101
LJL36400CU44X	36	LLA34600WU43X	39	LLL36600TU33X	40	LRL36400CU33X	36	S29388	101
LJL36400CU53X	36	LLA34600WU44X	39	LLL36600TU43X	40	LRL36400CU43X	36	S29389	101
LJL36400CU54X	36	LLA34600WU53X	39	LLL36600TU44X	40	LRL36400CU44X	36	S29390	101
LJL36400RU31X	40	LLA34600WU54X	39	LLL36600TU53X	40	LRL36400CU53X	36	S29391	101
LJL36400RU33X	40	LLA36000S40X	45	LLL36600TU54X	40	LRL36400CU54X	36	S29392	101
LJL36400RU43X	40	LLA36000S60X	45	LLL36600U31X	36	LRL36400U31X	36	S29393	101
LJL36400RU44X	40	LLA36250CU31X	40	LLL36600U33X	36	LRL36400U33X	36	S29394	101
LJL36400RU53X	40	LLA36250CU33X	40	LLL36600U43X	36	LRL36400U43X	36	S29402	101
LJL36400RU54X	40	LLA36250U31X	39	LLL36600U44X	36	LRL36400U44X	36	S29403	101
LJL36400TU31X	40	LLA36250U33X	39	LLL36600U53X	36	LRL36400U53X	36	S29404	101
LJL36400TU33X	40	LLA36400CU31X	40	LLL36600U54X	36	LRL36400U54X	36	S29405	101
LJL36400TU43X	40	LLA36400CU33X	40	LLL44250WU31X	38	LRL36600U31X	36	S29406	101
LJL36400TU44X	40	LLA36400CU43X	40	LLL44250WU33X	38	LRL36600U33X	36	S29407	101
LJL36400TU53X	40	LLA36400CU44X	40	LLL44400WU31X	38	LRL36600U43X	36	S29408	101
LJL36400TU54X	40	LLA36400CU53X	40	LLL44400WU33X	38	LRL36600U44X	36	S29409	101
LJL36400U31X	36	LLA36400CU54X	40	LLL44400WU43X	38	LRL36600U53X	36	S29410	101
LJL36400U33X	36	LLA36400U31X	39	LLL44400WU44X	38	LRL36600U54X	36	S29411	101
LJL36400U43X	36	LLA36400U33X	39	LLL44400WU53X	38	LRL46000S40X	45	S29412	101
LJL36400U44X	36	LLA36400U43X	39	LLL44400WU54X	38	LRL46000S60X	45	S29413	101
LJL36400U53X	36	LLA36400U44X	39	LLL44600WU31X	38	LRL46250CU31X	38	S29414	101
LJL36400U54X	36	LLA36400U53X	39	LLL44600WU33X	38	LRL46250CU33X	38	S29433	103
LJL36400U33X	36	LLA36400U54X	39	LLL44600WU43X	38	LRL46250U31X	38	S29434	103
LJL36600TU31X	40	LLA36600U31X	39	LLL44600WU44X	38	LRL46250U33X	38	S29435	103
LJL36600TU33X	40	LLA36600U33X	39	LLL44600WU53X	38	LRL46400CU31X	38	S29436	103
LJL36600TU43X	40	LLA36600U43X	39	LLL44600WU54X	38	LRL46400CU33X	38	S29437	103
LJL36600TU44X	40	LLA36600U44X	39	LLL46000S40X	45	LRL46400CU43X	38	S29438	103
LJL36600TU53X	40	LLA36600U53X	39	LLL46000S60X	45	LRL46400CU44X	38	S29439	103
LJL36600TU54X	40	LLA36600U54X	39	LLL46250CU31X	38	LRL46400CU53X	38	S29440	103
LJL36600U31X	36	LLF36000F25	41	LLL46250CU33X	38	LRL46400CU54X	38	S29450	98
LJL36600U33X	36	LLF36000F40	41	LLL46250U31X	38	LRL46400U31X	38	S29450	98
LJL36600U43X	36	LLF36000F60	41	LLL46250U33X	38	LRL46400U33X	38	S29452	98
LJL36600U44X	36	LLL34250WU31X	37	LLL46400CU31X	38	LRL46400U43X	38	S29452	98
LJL36600U53X	36	LLL34250WU33X	37	LLL46400CU33X	38	LRL46400U44X	38	S31540	103
LJL36600U54X	36	LLL34400WU31X	37	LLL46400CU43X	38	LRL46400U53X	38	S31541	103

PowerPact™ H-, J-, and L-Frame Circuit Breakers Catalog Numbers

S31542	103	S434204BS	83
S31543	103	S434205	83
S31544	103	S434206	84
S31545	103	S434210	83
S31546	103	S434212	92
S31548	103	S434300	93
S32514	122	S434301	93
S32514	122	S434302	93
S32515	122	S434303	82
S32515	122	S434303BS	83
S32523	122	S434500	93
S32525	122	S434501	93
S32532	122	S434502	93
S32533	122	S434503	93
S32534	114	S434504	93
S32534	122	S434505	93
S32558	113	S434506	93
S32560	114	S434507	93
S32562	122	S434508	93
S32562	122	SN100FA	116
S32563	122	SN100FA	116
S32563	122	SN400LA	116
S32648	103	SN400LA	116
S32649	103	SN400LA	116
S36967	123	SN400LA	116
S36967	125	STRV00121	79
S37420	103	STRV00210	81
S37420	103	STRV00211	81
S37423	124	STRV00910	85
S37423	124	STRV00911	85
S37424	124	SVW3A8114	85
S37424	124	TRV00128	79
S37425	125	TRV00217	81
S37426	125	TRV00803	86
S37427	125	TRV00806	86
S37428	125	TRV00810	86
S37429	124	TRV00820	86
S37430	124	TRV00830	86
S37442	122	TRV00850	86
S37443	122	TRV00870	86
S37444	125	TRV00880	86
S37445	125	TRV00915	85
S41940	103	TRV00917	85
S41940	103	VW3A8306DRC	86
S41940	103	YA060HD	127
S42888	103	YA150HD	127
S42888	103	YA150JD	127
S42888	103	YA250J35	127
S429424	100	YA400L31K3	127
S429441	103	YA400L51K3	127
S429449	103	YA400L51K4	127
S429449	103	YA400L71K3	127
S429478	69	YA400L71K4	127
S429481	69	YA600L32K3	127
S429483	69	YA600L32K4	127
S429484	69	YA600L52K3	127
S429521	92	YA600L52K4	127
S429532	100		
S430562	92		
S430563	92		
S431549	103		
S432459	69		
S432461	69		
S432553	114		
S432575	92		
S432639	103		
S432640	103		
S432641	103		
S432642	103		
S432643	103		
S432644	103		
S432645	103		
S432646	103		
S432647	103		
S432652	103		
S434201	82		
S434201BS	83		
S434202	82		
S434202BS	83		
S434204	82		

Glossary

accessory = An electrical or mechanical device that performs a secondary or minor function apart from overcurrent protection.

accessory cover = A removable cover on the front of a circuit breaker behind which are mounted the trip unit and all electrical accessories.

adjustable rating plug = A component which plugs into the trip unit, establishing the ampere rating of the circuit breaker

AIC = Amperes interrupting capacity.

AIR = See *amperes interrupting rating*.

alarm switch (bell alarm) = See *overcurrent trip switch*.

ambient temperature rating = Temperature at which the continuous current rating (handle rating) of a circuit breaker is based; the temperature of the air immediately surrounding the circuit breaker which can affect the thermal (overload) tripping characteristics of thermal-magnetic circuit breakers. Electronic trip circuit breakers, however, are insensitive to normal (-10° to 50°C) ambient conditions.

ammeter (local current meter) = A module that mounts directly to the circuit breaker trip unit and reports RMS phase and ground-fault current values as seen by the trip unit. Current values are displayed one phase at a time.

ampacity = The current, in amperes, that a conductor or circuit breaker can carry continuously under the conditions of use without exceeding its temperature rating.

ampere = The equivalent of one coulomb per second or the steady current produced by one volt applied across a resistance of one ohm.

amperes interrupting rating = The highest current at rated voltage that an overcurrent protective device is intended to interrupt under specified test conditions (NEC).

ANCE (National Association of Standardization and Certification for the Electrical Sector) = The standards and certification agency accredited by the Mexican government.

ANSI® = American National Standards Institute.

automatic molded case switch = A switch with construction similar to a molded case circuit breaker except that the switch opens only instantaneously at a non-adjustable trip point calibrated to protect only the molded case switch itself.

auxiliary switch = A switch mechanically operated by the main device for signaling, interlocking, or other purposes.

bell alarm = A mechanically-operated switch used to indicate the main contact position of a circuit breaker, which indicates when a circuit breaker has tripped. Also see *overcurrent trip switch*.

BPFE = See *electrical closing push button*.

branch circuit = The circuit between the final overcurrent device protecting the circuit and the outlet(s).

BCM = See *circuit breaker communications module*.

Canadian Standards Association® (CSA®) = Canadian product safety testing and certification organization.

carriage = See *cradle*.

CCM = See *cradle communication module*.

CD = See *cell switch*.

CDM = See *mechanical operation counter*.

CE = See *cell switch*.

cell switch = A switch which indicates the position of a drawout circuit breaker in relation to the cradle.

- **CD** = Disconnected position cell switch.
- **CE** = Connected position cell switch.
- **CT** = Test position cell switch.

CH = A spring-charged contact inside of the spring charging motor on insulated-case and low-voltage power circuit breakers.

charging handle = See *spring charging handle*.

circuit breaker = A device designed to open and close a circuit by non-automatic means and to open the circuit automatically on an overcurrent without damage to itself when properly applied within its rating.

circuit breaker communications module (BCM) = A module which, when installed in a circuit breaker, receives and transmits information on the communication network.

circuit breaker frame = (1) The circuit breaker housing which contains the current carrying components, the current sensing components, and the tripping and operating mechanism. (2) That portion of an interchangeable trip molded case circuit breaker remaining when the interchangeable trip unit is removed.

close button = A button for manually closing the main contacts after the closing springs are charged.

close button cover = A cover which fits over the close button and blocks access to it. Access to the close button may be permitted through the use of a tool or rod inserted through a small hole in the front of the close button cover.

closing coil (shunt close) = A coil which closes the circuit breaker electrically using an external voltage source when a specified voltage is applied across the coil.

coil clearing switch = A mechanically-operated switch in series with the coil of a shunt trip device which breaks the coil current when the circuit breaker opens.

communication network = A network allowing the flow of information between electrical components, comprised of programmable controller interface units, protocol software and modems.

conductor = A substance or body that allows a current of electricity to pass continuously along it.

continuous current rating (handle rating) (ampere rating) = The designated RMS alternating or direct current in amperes which a device or assembly will carry continuously in free air without tripping or exceeding temperature limits.

continuous load = A load where the maximum current on the circuit is expected to continue.

cradle communications module (CCM) = An external module which allows addressing of the cradle and retention of the address when the drawout circuit breaker is in the disconnected position and which is used to transmit information about the position of the circuit breaker in the cradle to the communication network.

cradle compartment = A compartment containing all connectors, shields, adapters, barriers, spreaders, shutters, keys and interlocking devices for a drawout circuit breaker.

CSA® = See *Canadian Standards Association*.

CT = Current transformer. See also *cell switch*.

current path (of a circuit breaker) = The current-carrying conductors within a circuit breaker between, and including, line and load terminations.

current transformer (current sensor) (CT) = An instrument to measure current, encircling a conductor carrying the current to be measured or controlled.

demand metering = The metering of power or current demand seen by a circuit breaker. It is calculated over a fixed or sliding time window that can be programmed from five to 60 minutes. Depending on the contract signed with the power supplier, specific programming makes it possible to avoid or minimize the cost of overrunning the subscribed power. Maximum demand values are systematically stored and time stamped.

disconnecting contacts = See *main disconnecting contacts* and *secondary disconnecting contacts*.

PowerPact™ H-, J-, and L-Frame Circuit Breakers Glossary

drawout circuit breaker = An assembly of a circuit breaker and a supporting structure (cradle) so constructed that the circuit breaker is supported and can be moved to either the main circuit connected or disconnected position without removing connections or mounting supports.

drawout mechanism = A mechanism which engages the drawout cradle assembly and draws the circuit breaker into or out of the equipment. The drawout mechanism includes the drawout mechanism shaft, drawout levering device arms and a drawout position indicator.

drawout position indicator = An indicating means which shows the position of the circuit breaker in the drawout structure.

drawout access cover (drawout shaft cover) = A shutter which allows or restricts access to the drawout shaft.

electrical closing push button (BPFE) = A push button used to electrically close a circuit breaker using a shunt close with communication option. This takes into account all safety functions that are part of the control and monitoring system of the installation.

electrical operator (motor operator) = An electrical device used to open and close a circuit breaker or switch and reset a circuit breaker. See also *spring charging motor*.

electronic trip circuit breaker = A circuit breaker which uses current sensors and electronic circuitry to sense, measure and respond to current levels.

fixed-mounted circuit breaker = A circuit breaker so mounted that it cannot be removed without removing primary and sometimes secondary connections and/or mounting supports.

frame size = The largest ampere rating available in a group of circuit breakers of similar physical configuration.

frequency = The number of cycles per second for an alternating current system.

frequency rating = The range of frequencies within which a product can be applied.

ground fault = An unintentional current path, through ground, back to the source.

ground-fault delay = The length of time the circuit breaker trip unit will delay before initiating a trip signal to the circuit breaker after a ground fault has been detected.

ground-fault module = An electronic accessory used in combination with thermal-magnetic circuit breakers to provide branch circuit ground-fault protection and ground-fault indication.

ground-fault pickup = The level of ground-fault current at which the trip system begins timing.

handle rating = Continuous current rating.

IDMTL = Long-time delay curve which can be varied in slope to enhance selectivity.

IEC® = International Electrotechnical Commission.

IEEE® = Institute of Electrical and Electronics Engineers.

Ig = See *ground-fault pickup*.

Ii = See *instantaneous pickup*.

In = See *sensor rating*.

individually-mounted circuit breaker = A circuit breaker so mounted that it cannot be removed without removing primary and sometimes secondary connections and/or mounting supports.

instantaneous pickup = The current level at which the circuit breaker will trip with no intentional time delay.

instantaneous trip = A qualifying term indicating that no delay is purposely introduced in the tripping action of the circuit breaker during short-circuit conditions.

insulated case circuit breaker (ICCB) = UL Standard 489 Listed non-fused molded case circuit breakers which utilize a two-step stored energy closing mechanism, electronic trip system and drawout construction.

integral ground-fault protection for equipment = Equipment ground-fault protection on grounded neutral systems provided by components internal to the circuit breaker.

interchangeable trip unit = A trip unit which can be interchanged by a user among circuit breaker frames of the same design.

interrupting rating = The highest current at rated voltage available at the incoming terminals of the circuit breaker. When the circuit breaker can be used at more than one voltage, the interrupting rating will be shown on the circuit breaker for each voltage level. The interrupting rating of a circuit breaker must be equal to or greater than the available short-circuit current at the point at which the circuit breaker is applied to the system.

inverse time = A qualifying term indicating there is purposely introduced a delay in the tripping action of the circuit breaker, which delay decreases as the magnitude of the current increases.

I_r = See *long-time pickup*.

I_{sd} = See *short-time pickup*.

I^2t = See *let-through current*.

I² t IN (I² t ON) = An inverse time delay characteristic.

I² t OUT (I² t OFF) = A constant time delay characteristic.

latch check switch = A mechanically-operated switch which senses if the trip latch is reset.

let-through current = The peak current (measured in amperes) which passes through an overcurrent protective device during an interruption.

let-through I²t = An expression related to energy (measured in ampere-squared seconds) which passes through an overcurrent protective device during an interruption.

LI = A combination of adjustable trip functions including long-time ampere rating, long-time delay, and instantaneous pickup.

lifting adapter = A device used with a crane, chain block or an optional lifting mechanism supplied with switchgear for removing and installing a drawout circuit breaker or fuse truck.

LIG = A combination of adjustable trip functions including long-time ampere rating, long-time delay, instantaneous pickup, ground-fault pickup and ground-fault delay.

limit switch = A switch mechanically operated by a device.

local current meter = An ammeter installed as part of the trip unit.

long-time ampere rating = An adjustment which, in combination with the installed rating plug, establishes the continuous current rating of a full-function electronic trip circuit breaker.

long-time delay = The length of time the circuit breaker will carry a sustained overcurrent (greater than the long-time pickup) before initiating a trip signal.

long-time pickup = The current level at which the circuit breaker long-time delay function begins timing.

low voltage power circuit breaker (LVPCB) = A circuit breaker tested to the ANSI C37 Standards with a two-step stored-energy mechanism, an electronic trip system, and drawout construction.

LS = A combination of adjustable trip functions including long-time ampere rating, long-time delay, short-time pickup, short-time delay and a defeatable instantaneous pickup.

LSG = A combination of adjustable trip functions including long-time ampere rating, long-time delay, short-time pickup, short-time delay, defeatable instantaneous pickup, ground-fault pickup and ground-fault delay.

LSI = A combination of adjustable trip functions including long-time ampere rating, long-time delay, short-time pickup, short-time delay and defeatable instantaneous pickup.

LSIG = A combination of adjustable trip functions including long-time ampere rating, long-time delay, short-time pickup, short-time delay, defeatable instantaneous pickup, ground-fault pickup and ground-fault delay.

PowerPact™ H-, J-, and L-Frame Circuit Breakers

Glossary

main disconnecting contacts = Spring-loaded and self-aligning contact on the rear of a drawout circuit breaker that provide positive electrical contact when the circuit breaker is in the connected position.

Masterpact™ = The family of universal power circuit breakers including insulated case circuit breakers and low-voltage power circuit breakers.

MCH = See *spring-charging motor*.

MDGF = Modified differential ground-fault system.

manual charging handle = A manually-operated handle which charges the circuit breaker closing springs.

mechanical operation counter (CDM) = A mechanical device which indicates the total number of circuit breaker operating cycles.

Micrologic™ = The family of electronic trip systems available on molded case circuit breakers, insulated case circuit breakers and low-voltage power circuit breakers.

miniature circuit breaker (MCB) = A small circuit breaker which is assembled as an integral unit in a supportive and enclosed housing of insulating material, rated 150 A or less and used in 120 V, 120/240 V, 240 V and 480Y/277 V ac systems and dc systems up to 125 Vdc.

MN = See *undervoltage release*.

Modbus™ communication network = A communication network comprised of programmable controller interface units, protocol software and modems.

molded case circuit breaker (MCCB) = A circuit breaker which is assembled as an integral unit in a supportive and enclosed housing of insulating material, generally 20 to 3000 A in size and used in systems up to 600 Vac and 500 Vdc.

motor circuit protector = A recognized component of construction similar to a circuit breaker except with no thermal elements so that it provides short-circuit protection only.

MX = See *shunt trip*.

National Association of Standardization and Certification for the Electrical Sector = See *ANCE*.

neutral current transformer = A current transformer which encircles the neutral conductor; required on circuit breakers with ground-fault protection, when applied on a grounded system.

NMX® (Norma Mexicana X) = Listing mark indicating certification to non-mandatory Mexican safety standards.

NOM = Listing mark indicating certification to mandatory Mexican safety standards

OF = See *auxiliary switch*.

open/closed indicator = An indicating means which displays the position (open or closed) of the main contacts.

operating mechanism = An internal mechanical system which opens and closes the circuit breaker contacts.

OTS = Overcurrent trip switch (alarm switch, bell alarm). A mechanical switch that operates when the circuit breaker is tripped by the trip system.

overcurrent = Any current in excess of the rated continuous current of equipment or the ampacity of a conductor.

overcurrent mechanism = An internal mechanical system which trips the circuit breaker during an overcurrent.

overcurrent trip element = A device which detects an overcurrent and transmits the energy necessary to open the circuit automatically (UL only).

overcurrent trip switch (SDE) = A mechanically-operated switch which indicates when a circuit breaker has tripped due to overcurrent conditions.

overload delay = The length of time the circuit breaker will carry a sustained low-level overcurrent before initiating a trip signal.

peak current sensing = A method of determining the current by means of detecting the current peaks.

peak let-through current = The maximum peak current flowing in a circuit during an overcurrent condition.

PF = A switch used to indicate a circuit breaker is ready to close.

phase barrier = A barrier which provides phase-to-phase or phase-to-ground isolation.

PowerLogic™ = The family of electronic circuit monitoring systems available on molded case circuit breakers, insulated case circuit breakers and low-voltage power circuit breakers.

Power-Zone™ = The family of low-voltage and medium-voltage switchgear.

programmable contact module (M6C and M2C) = A programmable module which indicates the type of fault and the instantaneous and delayed threshold overruns. It may be programmed with instantaneous return to the initial state, without return to the initial state, or with return to the initial state following a delay.

primary disconnect contacts = An electrical plug-on connector in the main current path between the drawout components and the cradle mounted in the equipment.

push-to-close button = A button for manually closing the main contacts after the closing springs are charged.

push-to-open button = A button for manually opening the circuit breaker.

push-to-trip button = A button for manually tripping the circuit breaker.

racking device shutter = See *drawout shaft cover*.

racking interlock = An interlock to prevent racking of a drawout circuit breaker when the enclosure door is open by not allowing the racking crank to be inserted into the circuit breaker.

rating plug = A component which plugs into the full-function electronic trip unit, establishing the maximum continuous current rating of the circuit breaker.

remote reset after fault (RES) = A component which resets the overcurrent trip switch (SDE) and the mechanical operator after tripping.

RES = See *remote reset after fault*.

residual ground-fault sensing = A means of providing equipment ground-fault protection utilizing sensors on each individual phase.

restraint interface module (RIM) = A component which allows zone-selective interlocking communication between Square D™ full-function electronic trip systems, add-on ground-fault modules and zero-sequence ground-fault relays.

RIM = Restraint interface module.

RMS = Root-mean-square.

RMS current sensing = A method of determining the true RMS current of sinusoidal and non-sinusoidal waveforms by sampling the current waveform a number of times per cycle, then calculating the true RMS value.

safety shutter = A device that closes to block access to the main disconnects when the circuit breaker is in the disconnected, test or withdrawn position.

SDE = See *overcurrent trip switch*.

secondary disconnect contacts = An electrical plug-on connector in the secondary (control) circuit between a drawout circuit breaker and its cradle in the equipment.

sensor = The current sensing element within the circuit breaker which provides the sensing function for that circuit breaker.

sensor plug = A component used with a Micrologic trip system to set the sensor size of a circuit breaker.

PowerPact™ H-, J-, and L-Frame Circuit Breakers

Glossary

sensor size = Maximum ampere rating possible for a specific circuit breaker, based on the size of the current sensor inside the circuit breaker. Sensor size is less than or equal to frame size.

SGR = Source ground return system.

short-circuit delay (STD) = The length of time the circuit breaker will carry a short circuit (current greater than the short-circuit pickup) before initiating a trip signal.

short-circuit pickup = The current level at which the circuit breaker short-circuit delay function begins timing.

short-time delay = The length of time the circuit breaker will carry a short circuit (current greater than the short-time pickup) before initiating a trip signal.

short-time pickup = The current level at which the circuit breaker short-time delay function begins timing.

shunt close (closing coil) (XF) = An accessory which closes the circuit breaker from a remote location using an external voltage source.

shunt trip (MX) = An accessory which trips the circuit breaker from a remote location using an external voltage source.

spring-charging handle = A handle located on the front of the circuit breaker used to manually charge the stored energy mechanism.

spring charging motor = A motor which electrically charges the stored energy closing spring(s).

STD = Short-time delay.

stored energy mechanism (SEM) = A spring mechanism that is compressed or “charged” and then released or “discharged” to close the circuit breaker.

terminal block = The connections for control wiring.

tg = See *ground-fault delay*.

thermal imaging = A trip unit function that accurately maps the heating and cooling effects of load behavior on rated conductors to provide thermal protection without nuisance tripping.

thermal-magnetic circuit breaker = A general purpose term for circuit breakers that use bimetals and electromagnetic assemblies to provide both thermal and magnetic overcurrent protection.

thermal memory = Provides continuous temperature rise status of the wiring for a period of time both before and after the device trips. This allows the circuit breaker to respond to a series of overload conditions which would otherwise go undetected.

t_r = See *long-time delay*.

t_{sd} = See *short-time delay*.

two-step stored energy mechanism = See *stored energy mechanism*.

transformer = A static device with primary winding, connected in series with the conductor (bus) carrying the current to be measured or controlled within the switchgear.

trip button = See *push-to-trip button*.

trip curve = A graphical representation of the response of a circuit breaker to current over a period of time.

trip indicator = A module that mounts directly to the circuit breaker trip unit that displays whether the circuit breaker tripped due to an overload, a short-circuit or a ground-fault condition.

trip indicator reset = A button on the trip indicator module used to reset the trip indicator.

trip system = A system which consists of a Micrologic trip unit and current transformers.

trip unit = A programmable device which measures and times current flowing through the circuit breaker and initiates a trip signal when appropriate.

UL® = See *Underwriters Laboratories Inc.*

undervoltage trip (MN, UVR) = An accessory which trips the circuit breaker automatically when the monitored circuit voltage falls below a predetermined percentage of its specified value.

Underwriters Laboratories Inc.® (UL®) = An independent, not-for-profit standards development, product safety testing and certification organization.

unit-mount circuit breaker = A circuit breaker mounted such that it cannot be removed without removing primary and sometimes secondary connections or mounting supports.

withstand rating = The level of RMS symmetrical current that a circuit breaker can carry with the contacts in a closed position for a stated period of time—usually stated in cycles.

zero-blind time = Metering method used by the Micrologic H trip unit where a dedicated metering data chain is separate from the protection data chain so that a greater number of data samples can be used for metering. This increases the number of samples taken per time period, which in turn gives the H trip unit a higher degree of metering accuracy.

zero-sequence ground-fault sensing = A means of providing equipment ground-fault protection utilizing an external sensor (surrounding all phase and neutral conductors).

zone-selective interlocking (ZSI) = A communication capability between electronic trip systems and ground-fault relays which permits a short circuit or ground fault to be isolated and cleared by the nearest upstream device with no intentional time delay.

ZSI = Zone-selective interlocking.

Schneider Electric USA, Inc.
3700 Sixth St. SW
Cedar Rapids, IA 52404 USA
1-888-778-2733
www.schneider-electric.us

Schneider Electric Canada, Inc.
5985 McLaughlin Road
Mississauga On, L5R 1B8
Tel: 1-800-565-6699
www.schneider-electric.ca

Square D, Schneider Electric, PowerPact, and Micrologic are trademarks or registered trademarks of Schneider Electric. Other trademarks used herein are the property of their respective owners.

0611CT1001 R01/13 © 2011–2013 Schneider Electric All Rights Reserved
Replaces 0611CT1001 R11/12